

# **marantz®**

**Model SR6400 User Guide**

---

AV Surround Receiver

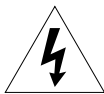
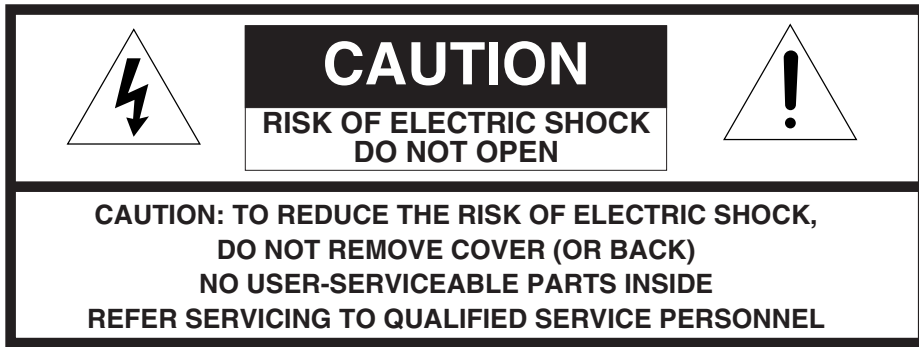

The lightning flash with arrowhead symbol within an equilateral triangle is intended to alert the user to the presence of uninsulated “dangerous voltage” within the product’s enclosure that may be of sufficient magnitude to constitute a risk of electric shock to persons.



The exclamation point within an equilateral triangle is intended to alert the user to the presence of important operating and maintenance (servicing) instructions in the literature accompanying the product.

## WARNING

**TO REDUCE THE RISK OF FIRE OR ELECTRIC SHOCK,  
DO NOT EXPOSE THIS PRODUCT TO RAIN OR MOISTURE.**

**CAUTION: TO PREVENT ELECTRIC SHOCK, MATCH WIDE BLADE OF PLUG  
TO WIDE SLOT, FULLY INSERT.**

**ATTENTION: POUR ÉVITER LES CHOC ÉLECTRIQUES, INTRODUIRE LA  
LAME LA PLUS LARGE DE LA FICHE DANS LA BORNE CORRESPONDANTE  
DE LA PRISE ET POUSSER JUSQU’AU FOND.**

### NOTE TO CATV SYSTEM INSTALLER:

This reminder is provided to call the CATV (Cable-TV) system installer’s attention to Section 820-40 of the NEC which provides guidelines for proper grounding and, in particular, specifies that the cable ground shall be connected to the grounding system of the building, as close to the point of cable entry as practical.

### NOTE:

This equipment has been tested and found to comply with the limits for a Class B digital device, pursuant to Part 15 of the FCC Rules. These limits are designed to provide reasonable protection against harmful interference in a residential installation. This equipment generates, uses and can radiate radio frequency energy and, if not installed and used in accordance with the instructions, may cause harmful interference to radio communications. However, there is no guarantee that interference will not occur in a particular installation. If this equipment does cause harmful interference to radio or television reception, which can be determined by tuning the equipment off and on, the user is encouraged to try to correct the interference by one or more of the following measures:

- Reorient or relocate the receiving antenna.
- Increase the separation between the equipment and receiver.
- Connect the equipment into an outlet on a circuit different from that to which the receiver is connected.
- Consult the dealer or an experienced radio/TV technician for help.

### NOTE:

Changes or modifications not expressly approved by the party responsible for compliance could void the user’s authority to operate the equipment.

# IMPORTANT SAFETY INSTRUCTIONS

## READ BEFORE OPERATING EQUIPMENT

This product was designed and manufactured to meet strict quality and safety standards. There are, however, some installation and operation precautions which you should be particularly aware of.

9. A product and cart combination should be moved with care. Quick stops, excessive force, and uneven surfaces may cause the product and cart combination to overturn.



1. Read Instructions – All the safety and operating instructions should be read before the product is operated.
2. Retain Instructions – The safety and operating instructions should be retained for future reference.
3. Heed Warnings – All warnings on the product and in the operating instructions should be adhered to.
4. Follow Instructions – All operating and use instructions should be followed.
5. Cleaning – Unplug this product from the wall outlet before cleaning. Do not use liquid cleaners or aerosol cleaners. Use a damp cloth for cleaning.
6. Attachments – Do not use attachments not recommended by the product manufacturer as they may cause hazards.
7. Water and Moisture – Do not use this product near water—for example, near a bath tub, wash bowl, kitchen sink, or laundry tub, in a wet basement, or near a swimming pool, and the like.
8. Accessories – Do not place this product on an unstable cart, stand, tripod, bracket, or table. The product may fall, causing serious injury to a child or adult, and serious damage to the product. Use only with a cart, stand, tripod, bracket, or table recommended by the manufacturer, or sold with the product. Any mounting of the product should follow the manufacturer’s instructions, and should use a mounting accessory recommended by the manufacturer.

10. Ventilation – Slots and openings in the cabinet are provided for ventilation and to ensure reliable operation of the product and to protect it from overheating, and these openings must not be blocked or covered. The openings should never be blocked by placing the product on a bed, sofa, rug, or other similar surface. This product should not be placed in a built-in installation such as a bookcase or rack unless proper ventilation is provided or the manufacturer’s instructions have been adhered to.
11. Power Sources – This product should be operated only from the type of power source indicated on the marking label. If you are not sure of the type of power supply to your home, consult your product dealer or local power company. For products intended to operate from battery power, or other sources, refer to the operating instructions.

12. Grounding or Polarization – This product may be equipped with a polarized alternating-current line plug (a plug having one blade wider than the other). This plug will fit into the power outlet only one way. This is a safety feature. If you are unable to insert the plug fully into the outlet, try reversing the plug. If the plug should still fail to fit, contact your electrician to replace your obsolete outlet. Do not defeat the safety purpose of the polarized plug.

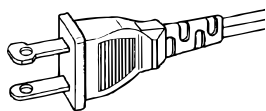

AC POLARIZED PLUG

13. Power-Cord Protection – Power-supply cords should be routed so that they are not likely to be walked on or pinched by items placed upon or against them, paying particular attention to cords at plugs, convenience receptacles, and the point where they exit from the product.
14. Protective Attachment Plug – The product is equipped with an attachment plug having overload protection. This is a safety feature. See Instruction Manual for replacement or resetting of protective device. If replacement of the plug is required, be sure the service technician has used a replacement plug specified by the manufacturer that has the same overload protection as the original plug.
15. Outdoor Antenna Grounding – If an outside antenna or cable system is connected to the product, be sure the antenna or cable system is grounded so as to provide some protection against voltage surges and built-up static charges. Article 810 of the National Electrical Code, ANSI/NFPA 70, provides information with regard to proper grounding of the mast and supporting structure, grounding of the lead-in wire to an antenna discharge unit, size of grounding conductors, location of antenna-discharge unit, connection to grounding electrodes, and requirements for the grounding electrode. See Figure 1.

16. Lightning – For added protection for this product during a lightning storm, or when it is left unattended and unused for long periods of time, unplug it from the wall outlet and disconnect the antenna or cable system. This will prevent damage to the product due to lightning and power-line surges.
17. Power Lines – An outside antenna system should not be located in the vicinity of overhead power lines or other electric light or power circuits, or where it can fall into such power lines or circuits. When installing an outside antenna system, extreme care should be taken to keep from touching such power lines or circuits as contact with them might be fatal.
18. Overloading – Do not overload wall outlets, extension cords, or integral convenience receptacles as this can result in a risk of fire or electric shock.
19. Object and Liquid Entry – Never push objects of any kind into this product through openings as they may touch dangerous voltage points or short-out parts that could result in a fire or electric shock. Never spill liquid of any kind on the product.
20. Servicing – Do not attempt to service this product yourself as opening or removing covers may expose you to dangerous voltage or other hazards. Refer all servicing to qualified service personnel.
21. Damage Requiring Service – Unplug this product from the wall outlet and refer servicing to qualified service personnel under the following conditions:
- When the power-supply cord or plug is damaged.
  - If liquid has been spilled, or objects have fallen into the product.
  - If the product has been exposed to rain or water.

- If the product does not operate normally following the operating instructions. Adjust only those controls that are covered by the operating instructions as an improper adjustment of other controls may result in damage and will often require extensive work by a qualified technician to restore the product to its normal operation.
- If the product has been dropped or damaged in any way, and
- When the product exhibits a distinct change in performance – this indicates a need for service.

22. Replacement Parts – When replacement parts are required, be sure the service technician has used replacement parts specified by the manufacturer or have the same characteristics as the original part. Unauthorized substitutions may result in fire, electric shock, or other hazards.
23. Safety Check – Upon completion of any service or repairs to this product, ask the service technician to perform safety checks to determine that the product is in proper operating condition.
24. Wall or Ceiling Mounting – The product should be mounted to a wall or ceiling only as recommended by the manufacturer.
25. Heat – The product should be situated away from heat sources such as radiators, heat registers, stoves, or other products (including amplifiers) that produce heat.

FIGURE 1  
EXAMPLE OF ANTENNA GROUNDING AS PER  
NATIONAL ELECTRICAL CODE, ANSI/NFPA 70

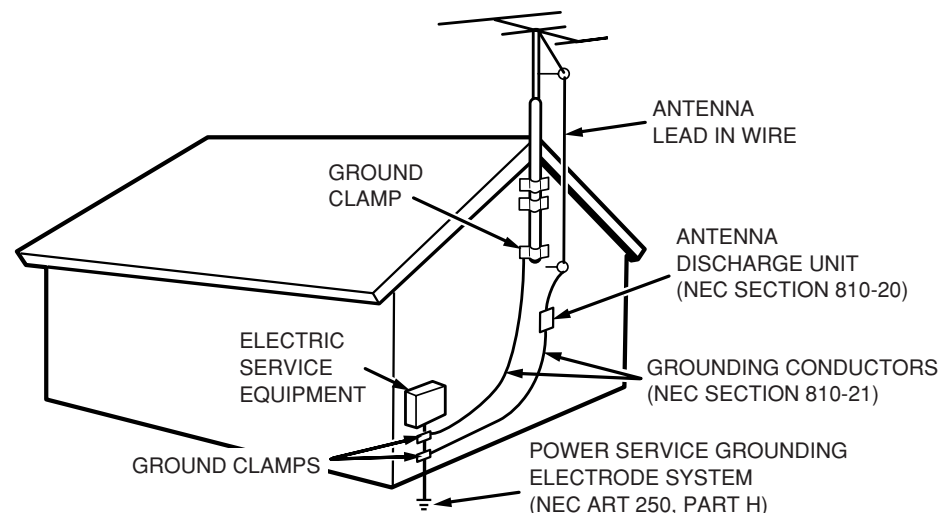

NEC - NATIONAL ELECTRICAL CODE

# TABLE OF CONTENTS

<b>INTRODUCTION</b> .....	<b>2</b>	<b>SURROUND MODE</b> .....	<b>20</b>
<b>PRECAUTIONS</b> .....	<b>2</b>	<b>OTHER FUNCTION</b> .....	<b>23</b>
<b>DESCRIPTION</b> .....	<b>2</b>	TV AUTO ON/OFF FUNCTION .....	23
<b>FEATURES</b> .....	<b>3</b>	ATTENUATION TO ANALOG INPUT SIGNAL .....	23
<b>ACCESSORIES</b> .....	<b>3</b>	LISTENING THROUGH HEADPHONES .....	23
<b>FRONT PANEL</b> .....	<b>4</b>	VIDEO ON/OFF .....	23
FL DISPLAY .....	5	DISPLAY MODE .....	23
<b>REAR PANEL</b> .....	<b>6</b>	SELECTING ANALOG AUDIO INPUT OR	
<b>REMOTE CONTROLLER RC7300SRa</b> .....	<b>7</b>	DIGITAL AUDIO INPUT .....	23
NAMES AND FUNCTIONS .....	7	RECORDING AN ANALOG SOURCE .....	24
REMOTE CONTROL RANGE .....	9	HT-EQ .....	24
LOADING BATTERIES .....	9	SPEAKER A/B .....	24
GENERAL INFORMATION OF RC7300SRa TO SR6400 .....	9	6.1 CH INPUT .....	24
<b>CONNECTIONS</b> .....	<b>10</b>	<b>BASIC OPERATION (TUNER)</b> .....	<b>25</b>
SPEAKER PLACEMENT .....	10	LISTENING TO THE TUNER .....	25
CONNECTING SPEAKERS .....	10	PRESET MEMORY .....	25
CONNECTING AUDIO COMPONENTS .....	11	<b>REMOTE CONTROLLER OPERATION</b> ...	<b>27</b>
CONNECTING VIDEO COMPONENTS .....	12	CONTROLLING MARANTZ COMPONENTS .....	27
ADVANCED CONNECTING .....	13	LEARN MODE .....	29
CONNECTING THE REMOTE CONTROL JACKS .....	13	MACRO MODE .....	30
CONNECTING THE ANTENNA TERMINALS .....	14	<b>TROUBLESHOOTING</b> .....	<b>32</b>
<b>SETUP</b> .....	<b>15</b>	<b>TECHNICAL SPECIFICATIONS</b> .....	<b>34</b>
ON SCREEN DISPLAY MENU SYSTEM .....	15	<b>DIMENSIONS</b> .....	<b>34</b>
1 INPUT SETUP (ASSIGNABLE DIGITAL INPUT) .....	16		
2 SPEAKER SETUP .....	16		
3 PREFERENCE .....	17		
4 SURROUND .....	18		
5 PL II (PRO LOGIC II) MUSIC PARAMETER .....	18		
6 CS II (CIRCLE SURROUND II) PARAMETER .....	18		
7 6.1 CH INPUT LEVEL .....	18		
<b>BASIC OPERATION (PLAY BACK) ...</b>	<b>19</b>		
SELECTING AN INPUT SOURCE .....	19		
SELECTING THE SURROUND MODE .....	19		
ADJUSTING THE MAIN VOLUME .....	19		
ADJUSTING THE TONE (BASS & TREBLE) CONTROL .....	19		
TEMPORARILY TURNING OFF THE SOUND .....	19		
USING THE SLEEP TIMER .....	20		
NIGHT MODE .....	20		

## INTRODUCTION

Thank you for purchasing the Marantz SR6400 Surround receiver.

This remarkable component has been engineered to provide you with many years of home theater enjoyment. Please take a few minutes to read this manual thoroughly before you connect and operate the SR6400.

As there are a number of connection and configuration options, you are encouraged to discuss your own particular home theater setup with your Marantz A/V specialist dealer.

## PRECAUTIONS

### CAUTIONS ON INSTALLATION

For heat dispersal, leave at least 20 cm/8 inch of space between the top, back and sides of this unit and the wall or other components.

- Do not obstruct the ventilation holes.

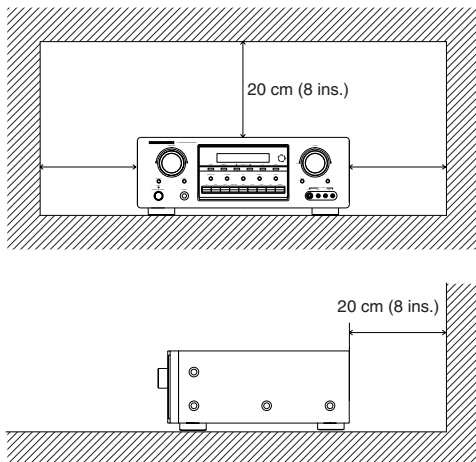

## DESCRIPTION



DTS was introduced in 1994 to provide 5.1 channels of discrete digital audio into home theater systems.

DTS brings you premium quality discrete multichannel digital sound to both movies and music.

DTS is a multichannel sound system designed to create full range digital sound reproduction.

The no compromise DTS digital process sets the standard of quality for cinema sound by delivering an exact copy of the studio master recordings to neighborhood and home theaters.

Now, every moviegoer can hear the sound exactly as the moviemaker intended.

DTS can be enjoyed in the home for either movies or music on of DVD's, LD's, and CD's.

"DTS" and "DTS Digital Surround" are registered trademarks of Digital Theater Systems, Inc.



The advantages of discrete multichannel systems over matrix are well known.

But even in homes equipped for discrete multichannel, there remains a need for high-quality matrix decoding. This is because of the large library of matrix surround motion pictures available on disc and on VHS tape; and analog television broadcasts.

The typical matrix decoder of today derives a center channel and a mono surround channel from two-channel matrix stereo material. It is better than a simple matrix in that it includes steering logic to improve separation, but because of its mono, band-limited surround it can be disappointing to users accustomed to discrete multichannel.

Neo:6 offers several important improvements as follow,

- Neo:6 provides up to six full-band channels of matrix decoding from stereo matrix material. Users with 6.1 and 5.1 systems will derive six and five separate channels, respectively, corresponding to the standard home-theater speaker layouts.
- Neo:6 technology allows various sound elements within a channel or channels to be steered separately, and in a way which follows naturally from the original presentation.

- Neo:6 offers a music mode to expand stereo nonmatrix recordings into the five- or six-channel layout, in a way which does not diminish the subtlety and integrity of the original stereo recording.



DTS-ES Extended Surround is a new multichannel digital signal format developed by Digital Theater Systems Inc. While offering high compatibility with the conventional DTS Digital Surround format, DTS-ES Extended Surround greatly improves the 360-degree surround impression and space expression thanks to further expanded surround signals. This format has been used professionally in movie theaters since 1999.

In addition to the 5.1 surround channels (FL, FR, C, SL, SR and LFE), DTS-ES Extended Surround also offers the SB (Surround Back) channel for surround playback with a total of 6.1 channels. DTS-ES Extended Surround includes two signal formats with different surround signal recording methods, as DTS-ES Discrete 6.1 and DTS-ES Matrix 6.1.

"DTS", "DTS-ES Extended Surround" and "Neo:6" are trademarks of Digital Theater Systems, Inc.



The stereo CD is a 16-bit medium with sampling at 44.1 kHz. Professional audio has been 20- or 24-bit for some time, and there is increasing interest in higher sampling rates both for recording and for delivery into the home. Greater bit depths provide extended dynamic range. Higher sampling rates allow wider frequency response and the use of anti-alias and reconstruction filters with more favorable aural characteristics.

DTS 96/24 allows for 5.1 channel sound tracks to be encoded at a rate of 96kHz/24bits on DVD-Video titles.

When DVD-video appeared, it became possible to deliver 24-bit, 96 kHz audio into the home, but only in two channels, and with serious limitations on picture. This capability has had little use.

DVD-audio allows 96/24 in six channels, but a new player is needed, and only analog outputs are provided, necessitating the use of the D/A converters and analog electronics provided in the player.

DTS 96/24 offers the following:

1. Sound quality transparent to the original 96/24 master.
2. Full backward compatibility with all existing decoders. (Existing decoders will output a 48 kHz signal)
3. No new player required: DTS 96/24 can be carried on DVD-video, or in the video zone of DVD-audio, accessible to all DVD players.
4. 96/24 5.1-channel sound with full-quality full-motion video, for music programs and motion picture soundtracks on DVD-video.



Dolby Digital identifies the use of Dolby Digital audio coding for such consumer formats as DVD and DTV. As with film sound, Dolby Digital can provide up to five full-range channels for left, center, and right screen channels, independent left and right surround channels, and a sixth (".1") channel for low-frequency effects.

Dolby Surround Pro Logic II is an improved matrix decoding technology that provides better spatiality and directionality on Dolby Surround program material; provides a convincing three-dimensional soundfield on conventional stereo music recordings; and is ideally suited to bring the surround experience to automotive sound. While conventional surround programming is fully compatible with Dolby Surround Pro Logic II decoders, soundtracks will be able to be encoded specifically to take full advantage of Pro Logic II playback, including separate left and right surround channels. (Such material is also compatible with conventional Pro Logic decoders.)

Dolby Digital EX creates six full-bandwidth output channels from 5.1-channel sources. This is done using a matrix decoder that derives three surround channels from the two in the original recording. For best results, Dolby Digital EX should be used with movies soundtracks recorded with Dolby Digital Surround EX.

Manufactured under license from Dolby Laboratories. "Dolby", "Pro Logic", and the double-D symbol are trademarks of Dolby Laboratories.



Circle Surround II (CS-II) is a powerful and versatile multichannel technology. CS-II is designed to enable up to 6.1 multichannel surround sound playback from mono, stereo, CS encoded sources and other matrix encoded sources. In all cases the decoder extends it into 6 channels of surround audio and a LFE/subwoofer signal. The CS-II decoder creates a listening environment that places the listener "inside" music performances and dramatically improves both hi-fi audio conventional surround-encoded video material. CS-II provides composite stereo rear channels to greatly improve separation and image positioning – adding a heightened sense of realism to both audio and A/V productions.

CS-II is packed with other useful feature like dialog clarity (SRS Dialog) for movies and cinema-like bass enrichment (TruBass). CS-II can enable the dialog to become clearer and more discernable in movies and it enables the bass frequencies contained in the original programming to more closely achieve low frequencies – overcoming the low frequency limitations of the speakers by full octave.

Circle Surround II, Dialog Clarity, TruBass, SRS and  symbol are trademarks of SRS Labs, Inc. Circle Surround II, Dialog Clarity and TruBass technology are incorporated under license from SRS Labs, Inc.

## FEATURES

The SR6400 incorporates the latest generation of digital surround sound decoding technology such as Dolby Digital EX, Dolby Digital, DTS ES (Discrete 6.1 and Matrix 6.1), DTS Neo:6 (Cinema, Music), Dolby Pro-Logic II (Movie and Music), Circle Surround II (Cinema and Music) . In addition, Marantz has focused on the future. By utilizing pre-out jacks, 6.1 direct inputs and a RS232C communication port, the SR6400 is tomorrow's technology, today!

The SR6400 features a fully discrete 6 channel amplifier section capable of delivering 100 watts of high-current amplification, for continuously clean and stable power into each of the six channels. It employs a massive EI power transformer in combination with oversized filter capacitors. This design configuration is capable of a clear and powerful reproduction of the most demanding action movie soundtracks and full range (multichannel) music discs. Through its ability to generate very high output voltages, the SR6400 can easily drive the most demanding speakers with optimum results.

The SR6400 incorporates the most advanced Digital Signal Processing circuitry, along with a Crystal<sup>®</sup> 192 kHz/24 bit D/A converter in each of the 7 channels. Independent power supply circuits are incorporated for the FL display, audio and video sections for maximum separation, clarity and dynamic range. Together with hand-selected customized components, all elements work in harmony to recreate the emotion, exactly as the artist had intended.

The SR6400 is designed and engineered with extensive feedback from custom installation experts, dealers and consumers. It features a RS232C communication port, heavy duty speaker binding posts and an extensive array of both analog and digital inputs / outputs. With 6 assignable digital inputs, 2 component inputs, SACD Multi Channel (6.1 channel) direct inputs and a speaker-B and OSD output versatility is taken to a stunning new level. Furthermore, the SR6400 can output the OSD information through the Y/C (S-video) and composite video outputs.

An easy-to-use programmable, learning remote control allows full access to all of the operating functions and can be used for system operation as well.

The new generation of Marantz Receivers is stylish and completely symmetrical. On the front panel of the SR6400, buttons are kept to a minimum. Source selectors and volume controls are intuitively placed. The large left dial knob on the left can be used as multi dial which allows all functions of the SR6400 to be operated via the front panel. The SR6400 is here to perform in your unrivaled home entertainment setup.

The TruSurround Headphone technology provides a surround sound listening experience over headphones.

When listening to multichannel content such as DVD movies over headphones, the listening experience is fundamentally different than listening to speakers. Since the headphone speaker drivers are covering the pinna of the ear, the listening experience differs greatly from traditional speaker playback. TruSurround utilizes patented headphone perspective curves to solve this problem and provides a non-fatiguing, immersive, home theater listening experience. TruSurround Headphone also delivers exceptional 3D audio from mono and stereo material.

- Dolby Digital EX, Dolby Digital , DTS ES (Discrete 6.1, Matrix 6.1, Neo: 6)
- Dolby Pro Logic II (Movie, Music)
- Circle Surround II (Movie, Music, Mono)
- 6 x 100 Watts (8 Ohm), Discrete Amplifiers
- Massive Energy Power Supply, Huge EI Transformer, Large ELCO's.
- 192 kHz/24 bit Crystal<sup>®</sup> DAC for all 7 Channels
- 32 bit Digital Surround Processing Chipsets
- Video Off Mode
- Large Heavy Duty Banana Type Speaker Terminals for all Channels
- RS232C Terminal for System Control
- Set Up Menu via Composite, and S-Video Output
- Auto Input Signal Detection
- Improved Station Name Input Method, 50 Presets
- Auto Adjust Function for Speaker Distance Settings (Delay Time)
- Large Multi Operation Left Dial Knob
- Programmable, learning remote control

## ACCESSORIES

### Remote Controller RC7300SRa

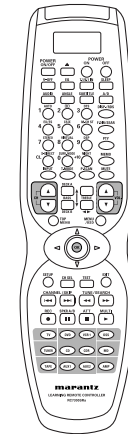

### AA-size batteries X 2

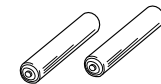

### AM Loop Antenna

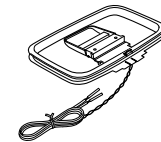

### FM Feeder Antenna

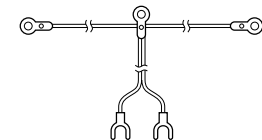

### FM Antenna converter



### Registration Card User Guide

## FRONT PANEL

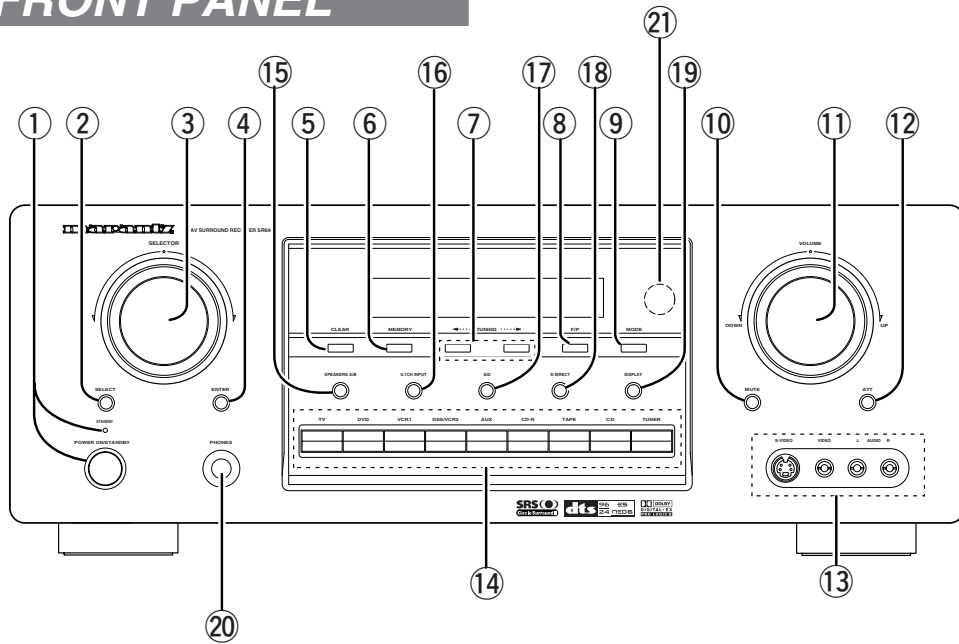

**① POWER switch and STANDBY indicator**  
When this switch is pressed once, the unit turns ON and the display illuminates. When pressed again, the unit turns OFF and the STANDBY indicator will be illuminated.

**② SELECT (MULTI FUNCTION MODE SELECT) button**  
Press this button to change the mode of the MULTI FUNCTION control dial. I.e. Surround Sound Fields, Tone Control & Set Up Menu.

**③ SURROUND MODE Selector & MULTI FUNCTION control dial**  
This dial changes surround modes & Tone Controls sequentially, and allows you to enter the OSD menu system.

**④ ENTER (MULTI FUNCTION ENTER) button**  
Press this button to enter the setup, which you have chosen by the MULTI FUNCTION dial.

**⑤ CLEAR button**  
Press this button to cancel the station-memory setting mode or preset scan tuning. (See page 25)

**⑥ MEMORY button**  
Press this button to enter the tuner preset memory numbers or station names. (See page 25)

**⑦ TUNING ◀ (Down) / ▶ (Up) buttons**  
Press these buttons to change the frequency or the preset number. (See page 25)

**⑧ F/P (Frequency / Preset) button**  
During reception of AM or FM, you can change the function of the UP/DOWN buttons for scanning frequencies or selecting preset stations by pressing these buttons. (See page 25)

**⑨ MODE button**  
Press this button to select the auto stereo mode or mono mode when the FM band is selected. The "AUTO" indicator lights in the auto stereo mode. (See page 25)

**⑩ MUTE button**  
Press this button to mute the output to the speakers. Press it again to return to the previous volume level.

**⑪ VOLUME control knob**  
Adjusts the overall sound level. Turning the control clockwise increases the sound level.

**⑫ ATT (Attenuate) button**  
If the selected analog audio input signal is greater than the capable level of internal processing, the PEAK indicator will illuminate. If this happens, you should press the ATT button. "ATT" is displayed when this function is activated. The signal-input level is reduced by about half. Attenuation will not work with the output signal of "REC OUT" (TAPE, CD-R/MD, VCR1 and VCR2 output). This function is memorized for each input function.

**⑬ AUX input jacks**  
These auxiliary video/audio input jacks accept the connections of a camcorder, portable DVD, game etc.

**⑭ INPUT FUNCTION SELECTOR buttons (AUDIO/ VIDEO)**  
These buttons are used to select the input sources. The video function selector, such as TV, DVD, VCR1, DSS and AUX, selects video and audio simultaneously.

Audio function sources such as CD, TAPE, CDR/MD, and TUNER may be selected in conjunction with a Video source. This feature (Sound Injection) combines a sound from one source with a picture from another. Choose the video source first, and then choose a different audio source to activate this function. Press the TUNER button to switch between FM and AM.

**⑮ SPEAKERS A/B button**  
Press these buttons to select speakers systems A and/or B.

**⑯ 6.1CH IN button**  
Press this button to select the output of an external multichannel decoder.

**⑰ A/D (Analog/Digital) SELECTOR button**  
This is used to select between the analog and digital inputs.

**Note:**

- This button is not used for an input source, that is not set to a digital input in the system setup menu.

**⑱ S- (Source) DIRECT button**  
When this button is pressed, the tone control circuitry is bypassed as well as Bass Management.

**Notes:**

- The surround mode is automatically switched to AUTO when the source direct function is turned on.
- Additionally, Speaker Configurations are fixed automatically as follows.  
Front SPKR = Large, Center SPKR = Large, Surround SPKR = Large, Sub woofer = On

**⑲ DISPLAY button**  
When this button is pressed, the FL display mode is changed as Surround Mode → Auto-display Off → Display Off → Input Function and the display off indicator (DISP) lights up in condition of DISPLAY OFF.

**⑳ HEADPHONE jack for stereo headphones**  
This jack may be used to listen to the SR6400's output through a pair of headphones. Be certain that the headphones have a standard 1 / 4" stereo phono plug. Note that the main room speakers will automatically be turned off when the headphone jack is in use.

**Notes:**

- When using headphones, the surround mode will change to STEREO and TruSurround (TS) headphones by SURROUND MODE selector.
- The surround mode returns to the previous setting as soon as the headphone plug is removed from the jack.

**㉑ INFRARED receiving sensor window**  
This window receives infrared signals for the remote control.

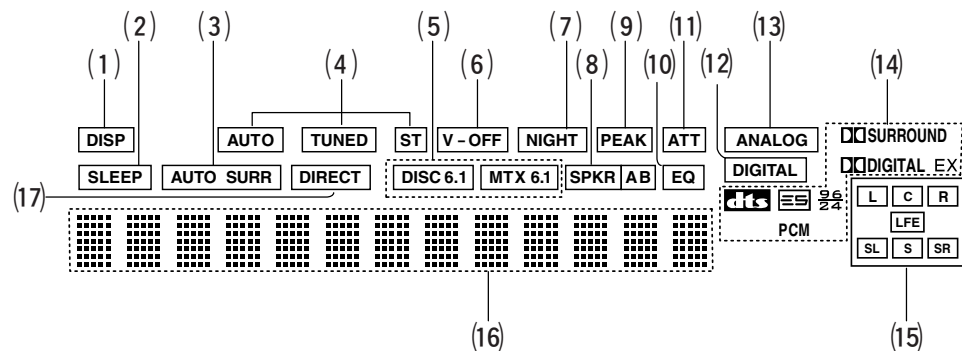

**(1) DISP (Display Off) indicator**

This indicator is illuminated when the SR6400 is in the display off condition.

**(2) SLEEP timer indicator**

This indicator is illuminated when the sleep timer function is in use.

**(3) AUTO SURR (Auto Surround mode) indicator**

This indicator illuminates to show that the AUTO SURROUND mode is in use.

**(4) TUNER's indicators**

**AUTO** : This indicator illuminates when the tuner's Auto mode is in use.

**TUNED** : This indicator illuminates when a station is being received with sufficient signal strength to provide acceptable listening quality.

**ST(Stereo)** : This indicator illuminates when an FM station is being tuned into stereo.

**(5) DTS-ES mode indicators (DISC6.1, MTX6.1)**

These indicators will illuminate to show the DTS-ES decoding mode (Discrete 6.1 or Matrix 6.1).

**(6) V (video)-OFF mode indicator**

This indicator is illuminated when the Video-OFF function is active.

**(7) NIGHT mode indicator**

This indicator is illuminated when the SR6400 is in the Night mode, which reduces the dynamic range of digital program material at low volume levels.

**(8) SPKR (speaker) AB indicator**

Active speaker system will be illuminated by this indicator.

**(9) PEAK indicator**

This indicator is a monitor for an analog audio input signal. If the selected analog audio input signal is greater than the capable level of internal processing, this will illuminate. If this happens, you should press the **ATT** button.

**(10) EQ mode indicator**

This indicator is illuminated when the HT-EQ function is active.

**(11) ATT (Attenuation) indicator**

This indicator is illuminated when the attenuation function is active.

**(12) DIGITAL Input Indicator**

This indicator is illuminated when a digital input has been selected.

**(13) ANALOG input indicator**

This indicator is illuminated when an analog input source has been selected.

**(14) SIGNAL FORMAT indicators**

**DIGITAL, EX, SURROUND, dts, ES, 96/24, PCM**

When the selected input is a digital source, some of these indicators will be illuminated to display the specific type of signal in use.

**(15) ENCODED CHANNEL STATUS indicators**

These indicators display the channels that are encoded with a digital input signal. If the selected digital input signal is Dolby Digital 5.1ch or DTS 5.1ch, "L", "C", "R", "SL", "SR" and "LFE" will be illuminated. If the digital input signal is 2 channel PCM-audio, "L" and "R" will be displayed.

If Dolby Digital 5.1ch signal with Surround EX flag or DTS-ES signal comes in, "L", "C", "R", "SL", "S", "SR" and "LFE" will be illuminated.

**(16) Main Information Display**

This display shows messages relating to the status, input source, surround mode, tuner, volume level or other aspects of unit's operation.

**(17) DIRECT (Source direct) indicator**

This indicator is illuminated when the SR6400 is in the SOURCE DIRECT mode.



# REAR PANEL

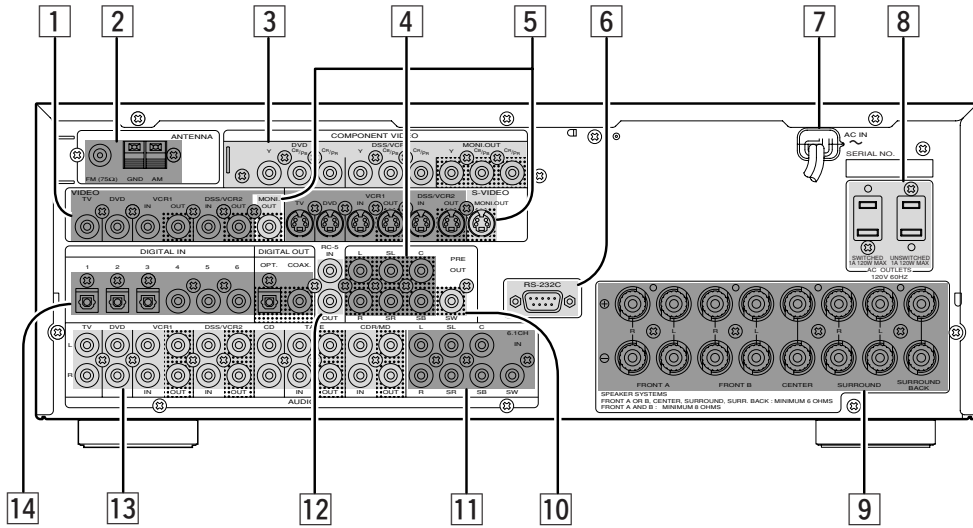

**1 VIDEO IN/OUT (TV, DVD, VCR1, DSS/VCR2)**

These are the video inputs and outputs. There are 4 video inputs and 2 video outputs and each one includes both composite video and S-video configurations. Connect VCRs, DVD players, and other video components to the video inputs. S-video sources can be viewed through the S-video outputs, and composite sources can only be viewed through the composite output. The 2 video output channels can be used to be connected to video tape recorders for making recordings.

**2 FM antenna terminal (75 ohms)**

Connect an external FM antenna with a coaxial cable, or a cable network FM source.

**AM antenna and ground terminals**

Connect the supplied AM loop antenna. Use the terminals marked "AM" and "GND". The supplied AM loop antenna will provide good AM reception in most areas. Position the loop antenna until you hear the best reception.

**3 COMPONENT VIDEO INPUT/OUTPUT**

If your DVD player or other device has component video connectors, be sure to connect them to these component video connectors on the SR6400. The SR6400 has two component video input connectors to obtain the color information (Y, C<sub>B</sub>, C<sub>R</sub>) directly from the recorded DVD signal or other video component and one component video output connector to output it directly into the matrix decoder of the display device.

By sending the pure DVD component video signal directly, the DVD signal forgoes the extra processing that normally would degrade the image. The result is vastly increased image quality, with incredibly life like colors and crisp detail.

**Notes:**

- This component video output will not display the OSD menu system.

**4 Preamp Outputs (L, R, SL, SR, SB, C)**

Jacks for L (front left), R (front right), C (Center), SL (surround left), SR (surround right) and SB (surround back).

Use these jacks for connection to external power amplifiers.

**5 MONITOR OUT**

This is a monitor output and each one includes both composite video and S-video configurations. When connecting two video monitors or televisions, be aware that the OSD interface can be used with both MONITOR OUT connections.

**6 RS232C**

The RS232C port is to be used in conjunction with an external controller to control the operation of the SR6400 by using an external device.

**7 Power cable**

Connect to an AC power outlet. SR6400 has to be powered by 120 V AC only.

**8 AC OUTLETS**

Connect the AC power cables of components such as a DVD and CD player to these outlets. SWITCHED and UNSWITCHED outlets are provided.

The one marked SWITCHED provides power only when the SR6400 is turned on and is useful for components which you use every time you play your system.

The one marked UNSWITCHED is always live as long as the SR6400 is plugged into a live outlet.

A component connected here may be left on permanently, or may be switched off with via its own power switch.

**Caution:**

- In order to avoid potential turn-off thumps, anything plugged into these outlets should be powered up before the SR6400 is turned on.
- The capacity of this AC outlet is 120W. Do not connect devices that consume electricity more than the capacity of these AC outlets. If the total power consumption of the connected devices exceeds the capacity, the protection circuit shuts down the power supply.

**9 Speaker outputs terminals**

Eight terminals are provided for the front (A) left, front (A) right, front (B) left, front (B) right, front center, surround left, surround right and surround back speakers.

**10 Subwoofer Output**

Connect this jack to the line level input of a powered subwoofer. If an external subwoofer amplifier is used, connect this jack to the subwoofer amplifier input. If you are using two subwoofers, either powered or with a 2 channel subwoofer amplifier, connect a "Y" connector to the subwoofer output jack and run one cable from it to each subwoofer amplifier.

**11 6.1 CHANNEL INPUT**

By connecting a DVD Audio player, SACD multichannel player, or other components that has a multichannel port, you can playback the audio with 5.1 channel or 6.1 channel outputs.

**12 REMOTE CONT. IN/OUT terminals**

Connect to a Marantz component equipped with remote control (RC-5) terminals.

**13 AUDIO IN/OUT (CD, TAPE, CD-R, TV, DVD, VCR1, DSS/VCR2)**

These are the analog audio inputs and outputs. There are 7 audio inputs (4 of which are linked to video inputs) and 4 audio outputs (2 of which are linked to video outputs). The audio jacks are nominally labeled for cassette tape decks, compact disc players, DVD players and etc.... The audio inputs and outputs require RCA-type connectors.

**14 DIGITAL INPUT (Dig.1 - 6) / OUTPUT (coaxial, optical)**

These are the digital audio inputs and outputs. There are 3 digital inputs with coaxial jacks, 3 with optical jacks.

The inputs accept digital audio signals from a compact disc, LD, DVD, or other digital source component.

For digital output, there is 1 coaxial output and 1 optical output.

The digital outputs can be connected to MD recorders, CD recorders, DAT decks, or other similar components.

# REMOTE CONTROLLER

## RC7300SRa

### NAMES AND FUNCTIONS

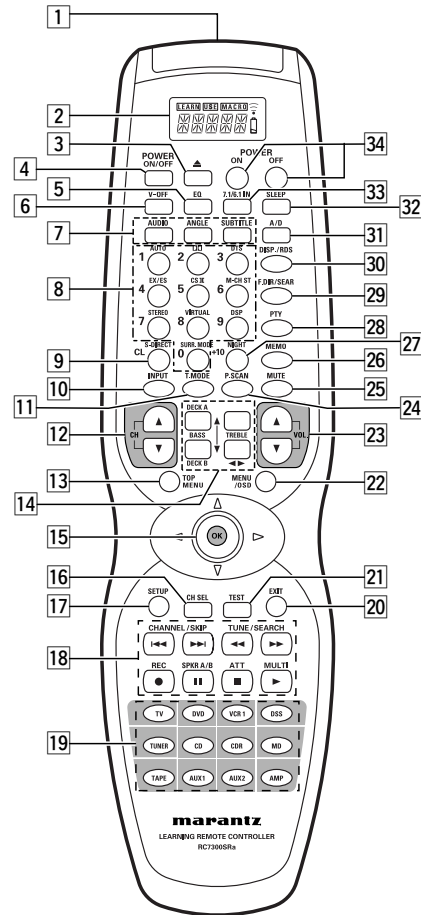

**1 Infrared window**  
Outputs and inputs-, infrared control signals.

**2 LCD (Liquid Crystal Display)**  
Used to display information about currently selected functions.

**3 ▲ (open/close) button**

Used to open or close the door.

**Note:**

- This button is unavailable for the SR6400.

**4 Source POWER ON/OFF button**

Used to turn specific sources (such as DVD players, etc.) ON and OFF independently from the rest of the system.

**5 EQ button**

Used to turn on or off HT (Home Theater)-EQ mode. This mode compensates for the audio portion of a movie sounding "bright". When this button is pressed, "EQ" indicator is illuminated.

**6 V-OFF (video off) button**

Used to turn off the video signal.

**7 DVD operating buttons**

*(when DVD mode is selected)*

**AUDIO button**

Used to select one of the audio languages.

**ANGLE button**

Used to change the different camera angles.

**SUBTITLE button**

Used to select one of the subtitle languages.

**8 Numeric buttons 1 to 9, 0 / Surround mode buttons**

**Numeric buttons**

Used to enter figures in the selection of a tuner preset station and station name preset or to select a CD track number, etc. The functions of these buttons are dependent on the function button selected.

**Surround mode buttons (when AMP mode is selected)**

Used to select the surround mode.

**9 CL (clear) / S-DIRECT (source direct) button**

Used to cancel certain memory or programming operations.

*(when AMP mode is selected)*

Used to select the S-DIRECT (source direct) mode. In source direct mode, the tone control circuitry is bypassed.

**10 INPUT button**

Used to select monitor input.

**Note:**

- This button is unavailable for SR6400.

**11 T.MODE button**

*(when TUNER mode is selected)*

Used to select the auto stereo mode or mono mode when the FM band is selected. The "AUTO" indicator is illuminated in the auto stereo mode.

**12 (TV) CH ▲/▼ buttons**

Used to increase or decrease the TV channels.

**13 TOP MENU button**

*(when DVD mode is selected)*

Used to call up the top menu of the DVD.

**14 Tone / Deck control buttons**

*Tone control buttons (when AMP mode is selected)*

The **TREBLE** buttons are used to adjust the tone control of high frequency sounds for the left and right speakers.

The **BASS** buttons are used to adjust the tone control of low frequency sounds for the left, right and subwoofer speakers.

**Deck control buttons (when Tape mode is selected)**

The **DECK A** button is used to select deck A.

The **DECK B** button is used to select deck B.

The ◀▶ buttons are used to change the direction.

**15 CURSOR / OK button**

Used to operate on-screen and other displays used by receivers and other components.

**16 CH SEL. (channel select) button**

*(when AMP mode is selected)*

Used to call up SETUP MAIN MENU and adjust speaker levels or 6.1 ch input level.

**17 SETUP button**

*(when AMP mode is selected)*

Used to call up the SETUP MAIN MENU of the SR6400.

**18 CONTROL buttons**

These buttons are used when operating the CD player, TAPE deck, etc.

The function of these buttons are dependent on the function button selected.

*(when AMP mode is selected)*

**ATT button**

When the input signal is too high and the voice distorts even while adjusting the SR6400 VOLUME control, turn on this function. "ATT" is illuminated when this function is activated.

The input level is reduced. Attenuator is invalid for the output signal of "REC OUT".

**Note:**

- This function is unavailable while the digital input is selected.

**SPKR A/B button**

Speaker mode is switched in the following sequence.

A → B → A+B → off

**Note:**

- The MULTI button is unavailable for SR6400.

**19 Input selector buttons/ FUNCTION SELECTOR buttons (AUDIO/VIDEO INPUT)**

Used to switch the remote control to the command sets for specific sources (amplifier, receiver, etc.), thereby allowing a single remote control to control up to 11 different components. To use these buttons to switch the amplifier's source, press the desired button twice within 2 seconds. The **AMP** button is used only to switch command set of the remote control itself and therefore does not transmit any signal. Further, the function buttons may also be programmed to execute macros. (A macro allows a complex string of operations to be performed in series simply by pressing a single button.) One button can be programmed to learn sequences containing up to 10 commands. The following is an example of such a sequence that can be activated automatically using a macro:

Turn the receiver ON → Switch the function to DVD → Set the Surround Mode to VIRTUAL → Set the DVD player to Play.

**Note:**

- The AUX2 button is unavailable for SR6400.

**20 EXIT button**

*(when AMP mode is selected)*

Used to exit setup menu.

**21 TEST button***(when AMP mode is selected)*

Used to enter the test tone menu.

**22 MENU/OSD button***(when AMP mode is selected)*

When this button is pressed, the current setting is displayed on the TV monitor.

**23 VOLUME ▲ / ▼ buttons**

Used to adjust the volume on receivers.

**24 P.SCAN (preset scan) button***(when TUNER mode is selected)*

Used to start preset scan when SR6400 is selected TUNER mode.

**25 MUTE button**

Muting button of the SR6400. Press this button decrease the sound temporarily. Press this button again to return to the previous sound.

**26 MEMO button**

Memory enable button for various preset functions.

**27 NIGHT button***(when AMP mode is selected)*

Pressing this button prevents the Dolby Digital signal from playback at a loud voice. This function reduces the voice by 1/3 to 1/4 at maximum. Thus, it eliminates the occurrence of an abruptly loud voice at night. However, the function is valid only in the case when the Dolby Digital signal is entered into OPTICAL or COAXIAL and data to compress the voice exists in the signal to be played back.

When this button is pressed, the "NIGHT" indicator is illuminated.

**28 PTY button (European model only)***(when TUNER mode is selected)*

Used to display the program type information of the current station. The RDS system categorizes programs according to their genre into different (PTY) groups.

**29 F.DIR/SEAR button***(when TUNER mode is selected)*

Used to select the mode for frequency direct input.

**30 DISP./RDS button***(when TUNER mode is selected: European model only)*

Selects display mode function for RDS (Radio Data System).

*(when AMP mode is selected)*

Selects the display mode for the front display of the SR6400.

**31 A/D button**

This is used to switch between the analog and digital inputs.

**32 SLEEP (sleep timer) button**

This button is used for setting the sleep timer. It can be operated the same way as the button on the unit.

**33 7.1/6.1CH IN button**

Press this button to select the output of an external multichannel decoder.

**34 POWER ON, OFF buttons***(when AMP mode is selected)*

Press to switch the power of the SR6400 ON or OFF.

**LCD (Liquid Crystal Display)**

Information about currently selected functions and modes are displayed on the LCD screen.

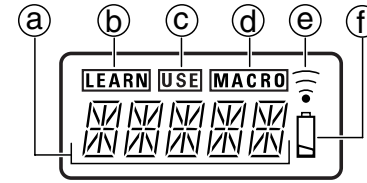
**a Function Name indicator**

Displays the name of the currently selected function (DVD, TV, etc.) using up to 5 characters.

**b LEARN indicator**

Indicates when the remote control is in the LEARN mode.

**c USE indicator**

For normal operation the USE indicator is displayed.

**d MACRO indicator**

Indicates when the remote control is in the MACRO mode.

**e Transmission indicator**

Indicates when the remote control is transmitting a signal.

**f Low battery indicator**

When this indicator appears, the batteries should be replaced.

## REMOTE CONTROL RANGE

The distance between the transmitter of the remote control and the IR SENSOR of the SR6400 should be less than 5 meters. If the remote control is pointed in a direction other than the IR SENSOR or if there is an obstacle between them, use of the remote control may not be possible.

### Remote-controllable range

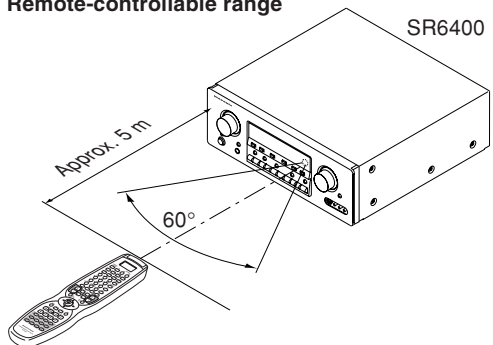

Remote control unit (RC7300SRa)

## LOADING BATTERIES

The life of the batteries used with the remote control is about 4 months with normal use. Also be sure to replace batteries earlier when you notice that they are getting weak.

1. Remove the back cover.

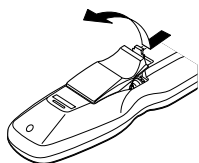

2. Insert the new batteries (AA type) with correct (+) and (-) polarity.

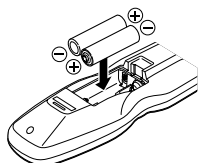

3. Close the cover until it clicks.

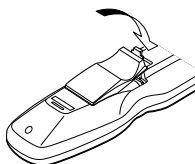

### Note:

- The supplied batteries are shipped to confirm the initial operation. Therefore, the supplied batteries will be consumed quickly.

## GENERAL INFORMATION OF RC7300SRa TO SR6400

To control the SR6400 by your RC7300SRa, you have to select the device AMP or TUNER by pressing the function selector button. Please refer below for the details in AMP and TUNER mode.

## AMP MODE

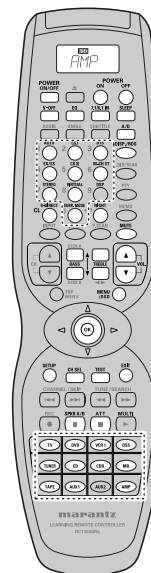

## TUNER MODE

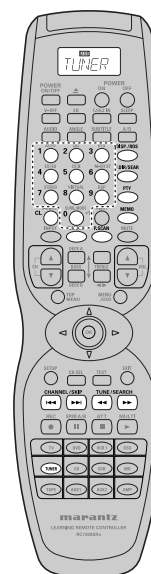

POWER ON/OFF	Turns the SR6400 on and off
POWER ON	Turns the SR6400 on
POWER OFF	Turns the SR6400 off
V-OFF	Turns on or off the Video OFF mode
EQ	Turns on or off the HT-EQ mode
7.1/6.1 IN	Selects the 6.1CH IN
SLEEP	Sets the sleep timer function
A/D	Switches between the analog and digital inputs
DISP./RDS	Changes the front display mode
Surround mode (0-9)	Selects the surround mode * DSP button is unavailable to SR6400.
S-DIRECT	Selects the Source Direct mode
NIGHT(+10)	Turns on or off the NIGHT mode
MUTE	Decreases the sound temporarily
BASS ▲▼	Adjusts the tone control of low frequency sound
TREBLE ▲▼	Adjusts the tone control of high frequency sound
VOL ▲▼	Adjusts the over all sound level
MENU/OSD	Displays the current setting on the monitor
Cursor	Moves the cursor for settings in the "On screen display" mode
OK	• Enters the "On screen display" • Confirms the settings in "On screen display" mode
SETUP	Same as the OK button
CH SEL	Calls up SETUP MENU and adjusts speaker levels or 6.1ch input level
TEST	Enters the test tone menu
EXIT	Exits from the SETUP MAIN MENU
SPKR A/B	Selects the speaker system
ATT	Reduces the input level
Function selector	Selects a particular source component

0-9	Inputs the numeric #s
DISP./RDS	Selects the display mode in RDS (*)
F.DIR/SEAR	Selects the "Frequency direct input"
PTY	Displays the programmed information of the current station (*)
MEMO	Enters the tuner preset memory numbers
CL	Clears the inputting
T.MODE	Selects the auto stereo mode or mono mode
P.SCAN	Starts preset scan
CHANNEL/SKIP	• Selects a preset station • Changes a PTY type
TUNE/SEARCH	Tunes a station
TUNER	Selects a frequency band

(\*): European model only

# CONNECTIONS

## SPEAKER PLACEMENT

The ideal surround speaker system for this unit is 7-speaker systems, using front left and right speakers, a center speaker, surround left and right speakers, a surround back and a subwoofer.

For best results we recommend that all front speakers be of the same type, with identical or similar driver units. This will deliver smooth pans across the front sound stage as the action moves from side to side.

Your center channel speaker is very important as over 80 % of the dialog from a typical motion picture emanates from the center channel.

It should possess similar sonic characteristics to the main speakers. Surround channel speakers need not be identical to the front channel speakers, but they should be of high quality.

The surround center speaker is useful for playback of Dolby Digital Surround EX or DTS-ES. One of the benefits of both Dolby Digital and DTS is that surround channels are discrete full range, while they were frequency limited in earlier "Pro Logic" type systems.

Bass effects are an important part of home theater. For optimal enjoyment a subwoofer should be used as it is optimized for low frequency reproduction. If you have full range front speakers, however, they may be used in place of a subwoofer with proper setting of the switches in the menu system.

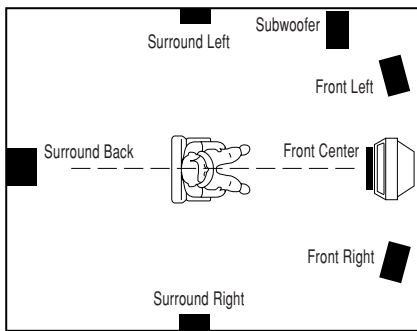

### Front left and right speakers

We recommend to set the front L and R speakers with 45-60 degrees from the listening position.

### Center speaker

Align the front line of the center speaker with the front L/R speakers. Or place the center speaker a little backward from the line.

### Surround left and right speakers

Place the speakers right beside of the listening position or a little backward.

### Surround back speaker

Place the speaker behind the listening position.

### Subwoofer

We recommend using a sub-woofer to have maximum bass effect. Sub-woofer bears only low frequency range so you can place it any where in the room.

## HEIGHT OF THE SPEAKER UNITS

### Front left and right speakers, and a center speaker

Align the tweeters and mid-range drivers on the three front speakers at the same height, as best as possible.

### Surround left and right speakers, and surround back speaker

Place the surround left, right and surround back speakers higher than your ears by about 2 Ft. - 3 Ft. (70cm - 1m). Also place the speakers at the same height, as best as possible.

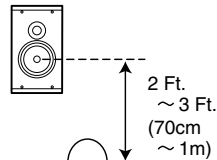

### Note;

- Use magnetically-shielded speakers for front left, right and the center speakers when the speakers are installed near the TV and the TV is a monitor type.

## CONNECTING SPEAKERS

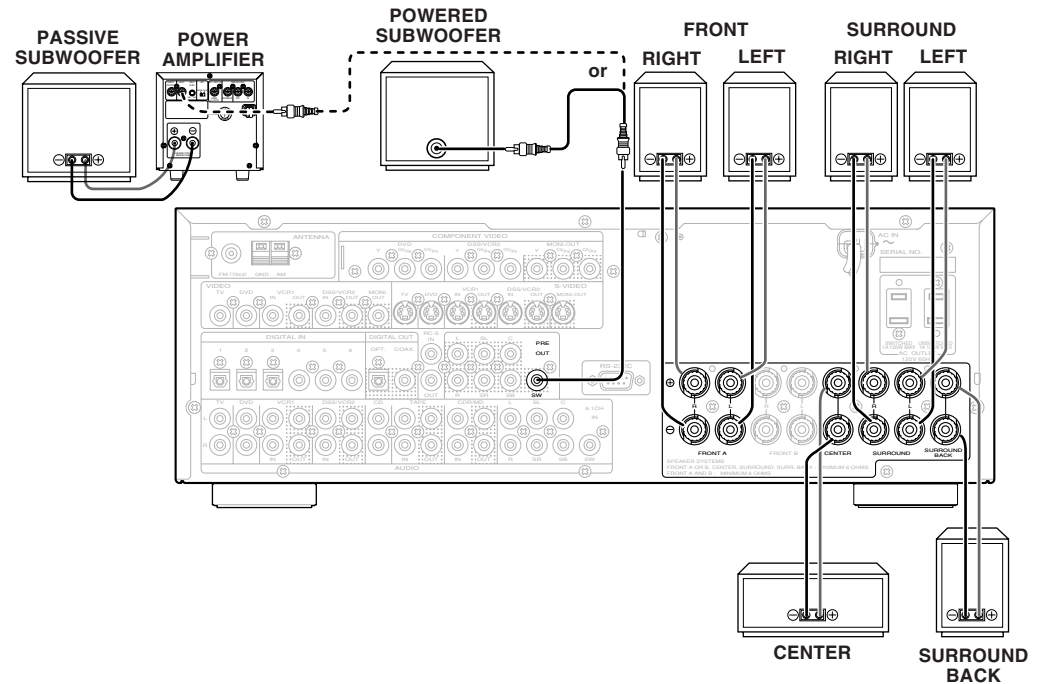

## CONNECTING SPEAKER WIRE

1. Strip away approx. 3/8 inch (10 mm) of wire insulation.
2. Twist the bared wire ends tight, to prevent short circuits.
3. Loosen the knob by turning it counterclockwise.
4. Insert the bare part of the wire into the hole in side of each terminal.
5. Tighten the knob by turning it clockwise to secure the wire.

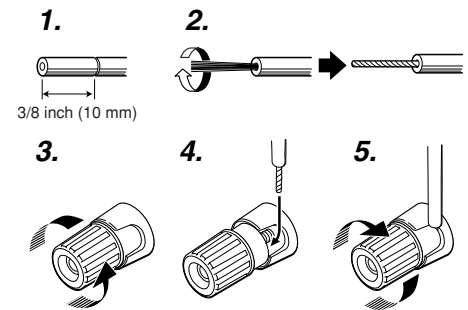

### CONNECTING BANANA PLUG

Banana plug connections are also possible. Tighten the knob by turning clockwise and then insert the banana plug.

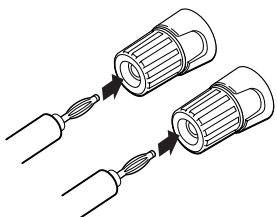

**Caution:**

- Be sure to use speakers with the specified impedance as shown on the rear panel of this unit.
- To prevent damage to circuitry, do not let the bare speaker wires touch each other and do not let them touch any metal part of this unit.
- Do not touch the speaker terminals when the power is on. It may cause you to receive an electric shocks.
- Do not connect more than one speaker cable to one speaker terminal. Doing so may damage this unit.

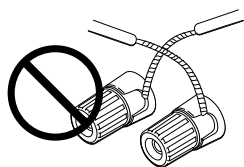

**Note:**

- Be sure to connect the positive and negative cables for the speaker properly. If they are miss-connected, the signal phase will be reversed and the signal quality will be corrupted.

### CONNECTING A SUBWOOFER

Use the PRE OUT SUBWOOFER jack to connect a powered subwoofer (power amplifier built in ). If your subwoofer is a passive type (power amplifier is not built in), connect a monaural power amplifier to the PRE OUT SUBWOOFER jack and connect the subwoofer to the amplifier.

### CONNECTING AUDIO COMPONENTS

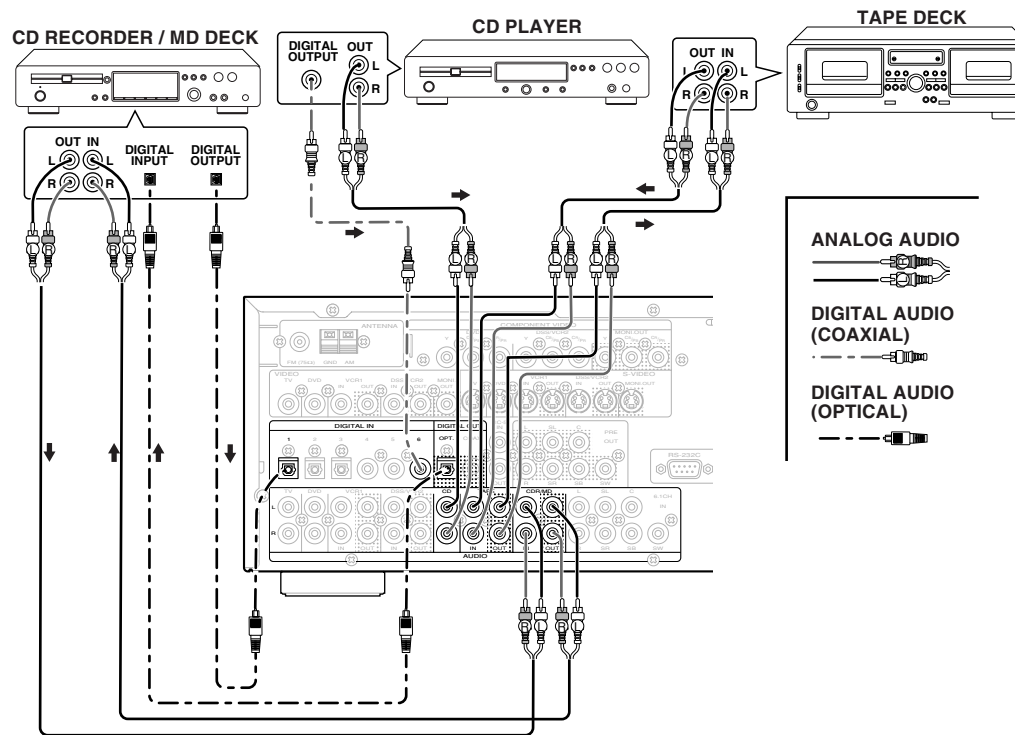

The output audio signal from the TAPE OUT jack and the CD-R/MD OUT jack is the same signal which is currently selected.

**Caution:**

- Do not connect this unit and other components to mains power until all connections between components have been completed.

**Notes:**

- Insert all plugs and connectors securely. Incomplete connections may make noise.
- Be sure to connect the left and right channels properly. Red connectors are for the R (right) channel, and white connectors are for the L (left) channel.
- Be sure to connect input and output properly.
- Refer to the instructions for each component that is connected to this unit.
- Do not bind audio/video connection cables with power cords and speaker cables this will result in generating a hum or other noise.

### CONNECTING DIGITAL AUDIO COMPONENTS

- There are 6 digital inputs, 3 coaxial jacks and 3 optical jacks, on the rear panel. You can use these jacks to input PCM, Dolby Digital and DTS bitstream signals from a CD, DVD, or other digital source components.
- There is one digital output coaxial jack and one optical output jack on the rear panel. These jacks can be connected to a CD recorder-, or a MD deck inputs, respectively.
- Refer to the instructions for each component. To setup the digital audio format of DVD player, or other digital source's connected to digital input jacks.
- Use fiber optical cables (optical) for DIG-1,2,3 input jacks. Use 75 ohms coaxial cables (for digital audio or video) for DIG-4, 5, 6 input jacks.
- You can designate the input for each digital input/output jacks according to your component. See page 16.

**Notes:**

- There is no Dolby Digital RF input jack. Please use an external RF demodulator Dolby Digital decoder when connecting the Dolby Digital RF output jack of the video disc player to the digital input jack.
- The digital signal jacks on this unit conform to the EIA standard. If you use a cable that does not conform to this standard, this unit may not function properly.
- Each type of audio jack works independently. Signals input through the digital and analog jacks are output through the corresponding digital and analog jacks, respectively.

CONNECTING VIDEO COMPONENTS

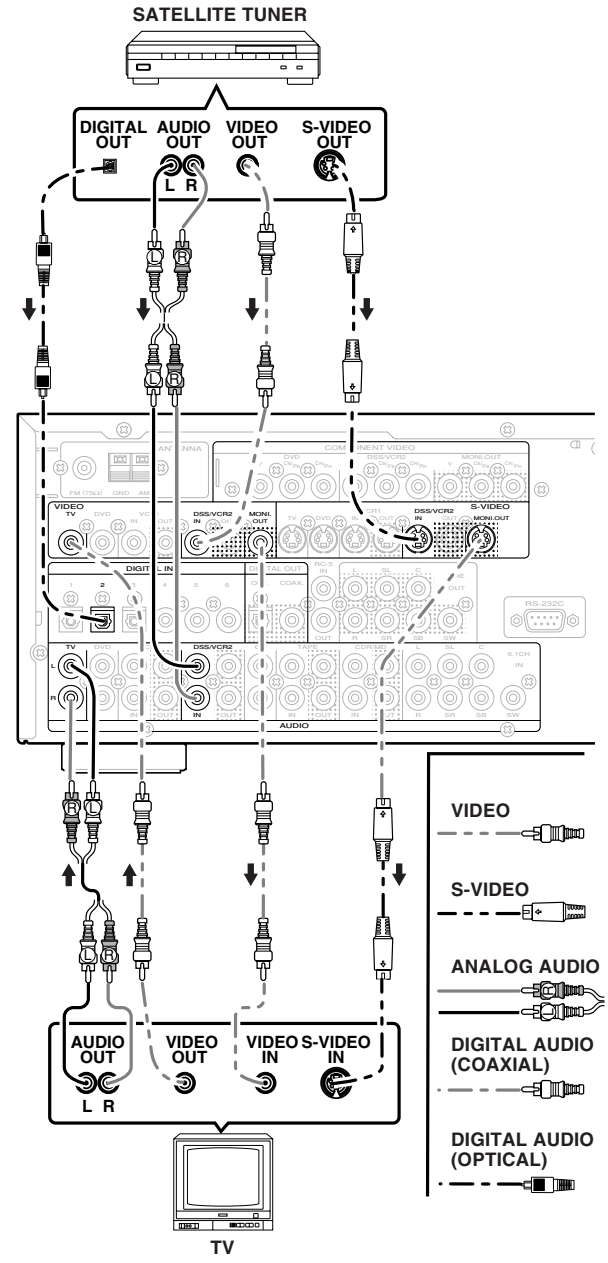
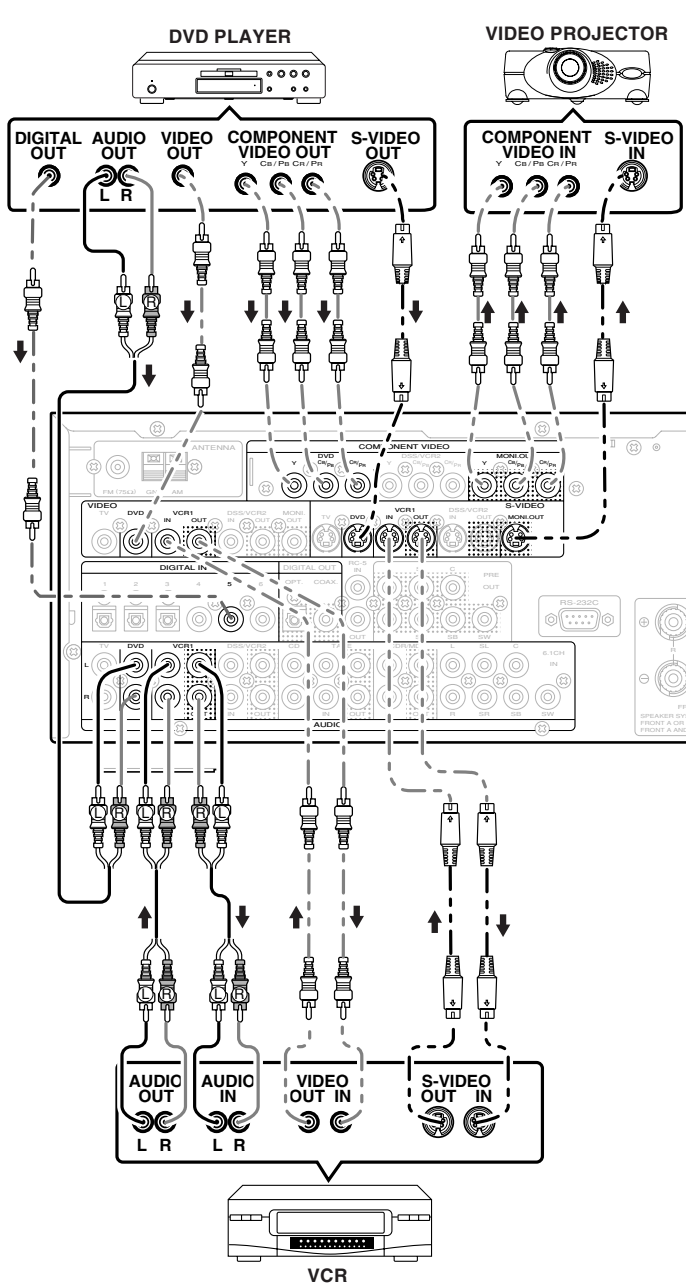

**VIDEO**

**S-VIDEO**

**ANALOG AUDIO**

**DIGITAL AUDIO (COAXIAL)**

**DIGITAL AUDIO (OPTICAL)**

VIDEO, S-VIDEO, COMPONENT JACKS

There are 3 types of video jacks on the rear panel.

**VIDEO jack**

The video signal for the VIDEO jacks is the conventional composite video signal.

**S-VIDEO jack**

The video signal is separated into luminance (Y) and color (C) signals for the S-VIDEO jack. The S-VIDEO signals enables high-quality color reproduction. If your video component has an S-VIDEO output, we recommend to use it. Connect the S-VIDEO output jack on your video component to the S-VIDEO input jack on this unit.

**Component jack**

Make component video connections to a TV or monitor with component inputs to produce higher quality video images. Use a component video cable or 3 video cords to connect the component video out jacks on the SR6400 to the monitor.

**Notes:**

- Be sure to connect the left and right audio channels properly.  
 Red connectors are for the R (right) channel, and white connectors are for L (left) channel.
- Be sure to connect the inputs and outputs of the video signals properly.
- If you connect the S-VIDEO or component signal to the S-VIDEO or component jack on this unit, it is not necessary to connect the conventional video signal to the VIDEO (composite) jack. If you use both video inputs, this unit gives priority to the S-VIDEO signal.
- Each type of video jack works independently. Signals input to the VIDEO (composite) and S-VIDEO jacks or component are output to the corresponding VIDEO (composite) and S-VIDEO or component jacks, respectively.
- This unit has the "TV-AUTO ON/OFF" function to turn the TV ON or OFF automatically, by sensing the incoming video signal from the VIDEO jacks.
- You may need to setup the digital audio output format of your DVD player, or other digital source components. Refer to the instructions of the each component connected to the digital input jacks.
- There is no Dolby Digital RF input jack. Please use an external RF demodulator with a Dolby Digital decoder to connect a video disc player which has a Dolby Digital RF output jack to the digital input jack on this unit.

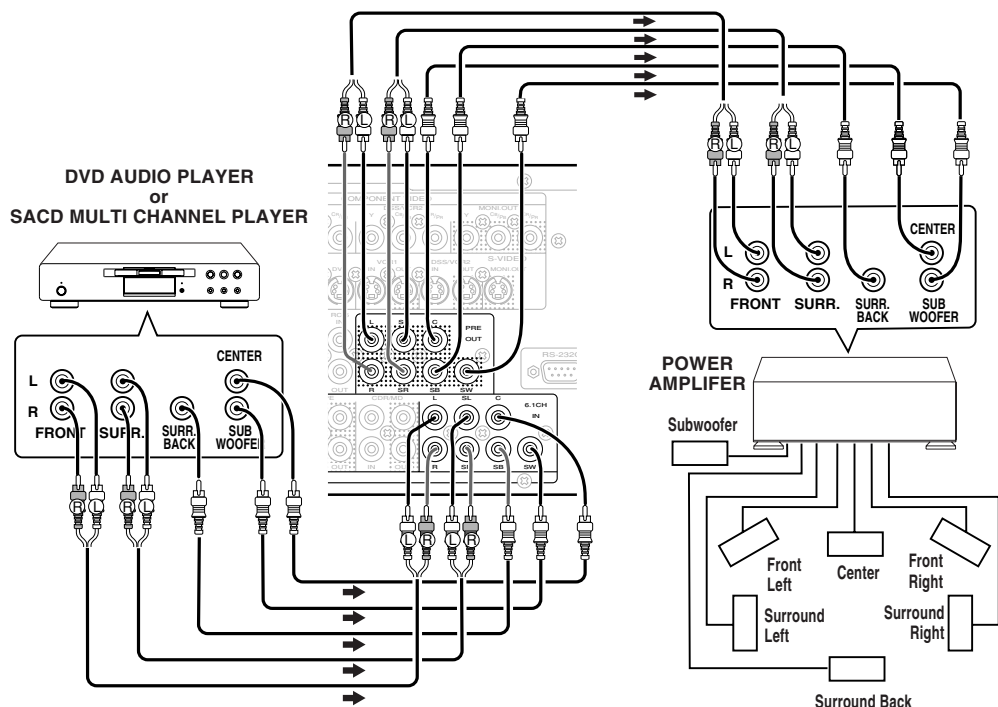

**CONNECTING MULTI CHANNEL AUDIO SOURCE**

The 6.1CH INPUT jacks are for multichannel audio source such as a SACD multichannel player, DVD audio player or external decoder. If you use these jacks, switch on the 6.1CH INPUT and set the 6.1CH INPUT level by using the SETUP MAIN MENU. See page 18.

**CONNECTING AN EXTERNAL POWER AMPLIFIER**

The PREOUT jacks are for connecting external power amplifiers. Be sure to connect each speaker to the corresponding external power amplifier.

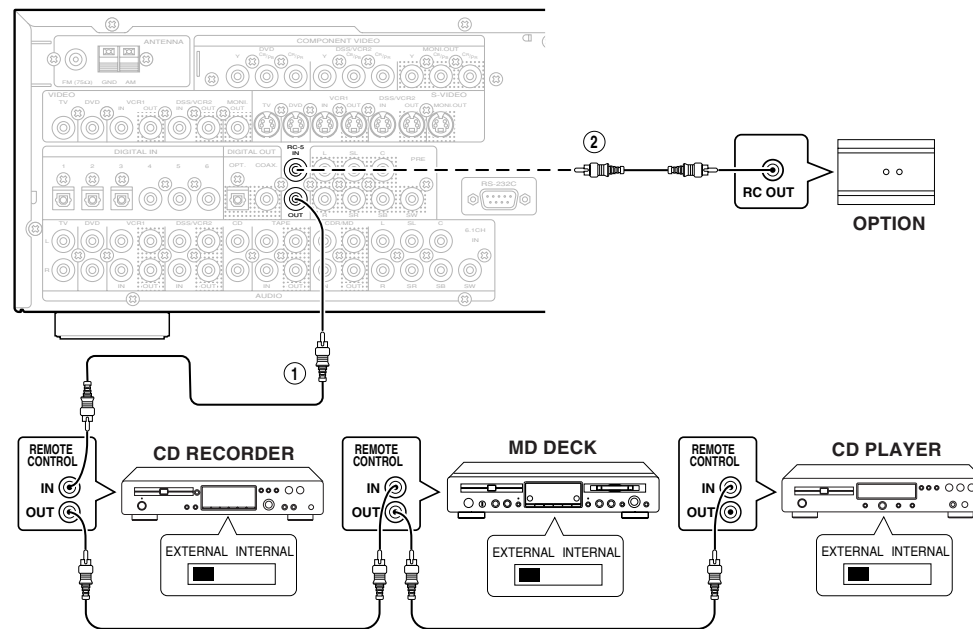

①

You can control other Marantz products through this unit with the remote control by connecting the REMOTE CONTROL terminals on each unit. The signal transmitted from the remote control is received by the remote sensor on this unit. Then the signal is sent to the connected device through this terminal. Therefore you need to aim the remote signal only to the unit. Also, if a Marantz power amplifier (some models excluded) is connected to one of these terminals, the power amplifier's power switch is synchronized with this unit's power switch.

Set the REMOTE CONTROL SWITCH on the units, other than the main unit to EXT.(EXTERNAL) for this feature.

②

Whenever external infrared sensors or similar devices are connected to RC-5 IN of the SR6400, be sure to always disable operation of the infrared sensor on the main unit by using the following procedure.

1. Hold down the **SELECT** button and **TV** button on the front panel at the same time for five seconds.
2. The setting "IR=ENABLE" is shown on the FL DISPLAY.
3. Press the **SELECT** button to change this to "IR=DISABLE".
4. Press the **ENTER** button. Once this setting is made, the infrared sensor on the main unit is disabled.

**Note:**

Be sure to set to "IR=ENABLE" when external infrared sensors or similar devices are not connected. Otherwise, the main unit will be unable to receive remote control commands.

5. To restore the original setting, perform steps 1 to 4 to set to "IR=ENABLE".



## CONNECTING THE ANTENNA TERMINALS

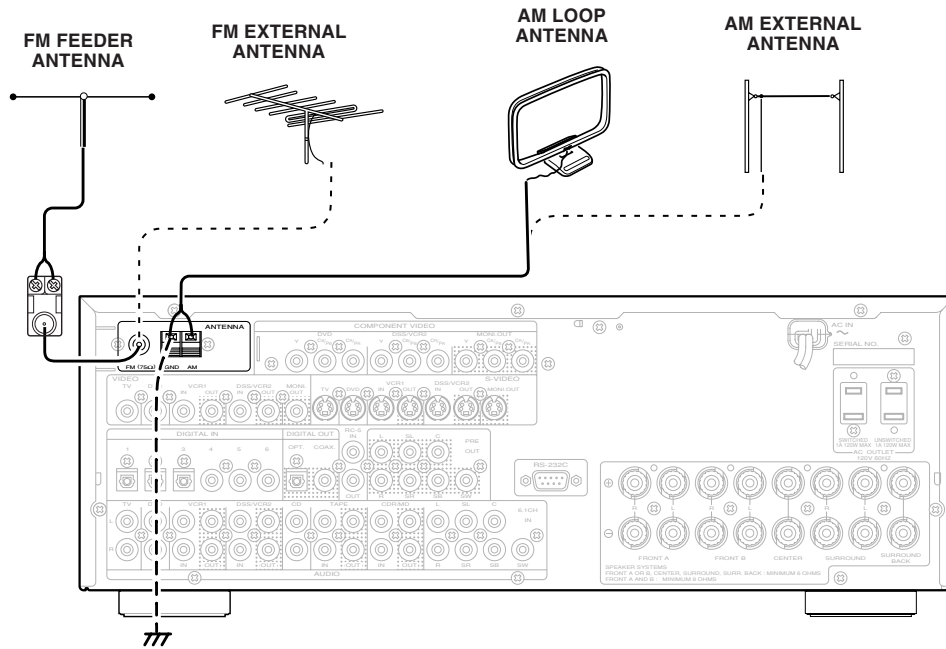

### ASSEMBLING THE AM LOOP ANTENNA

1. Release the vinyl tie and take out the connection line.

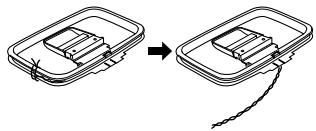

2. Bend the base part in the reverse direction.



3. Insert the hook at the bottom of the loop part into the slot at the base part.

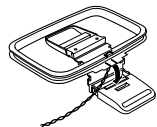

4. Place the antenna on stable surface.

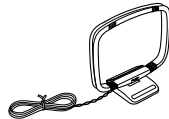

### CONNECTING THE ANTENNA WIRE TO THE ANTENNA CONVERTER

Loosen the screws and fix the terminals of wire. Then tighten the screws with a screwdriver.

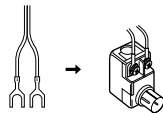

## CONNECTING THE SUPPLIED ANTENNAS

### Connecting the supplied FM feeder antenna

The supplied FM feeder antenna is for indoor use only.

During use, extend the antenna and move it in various directions until the clearest signal is received. Fix it with push pins or similar implements in the position that will cause the least amount of distortion. If you experience poor reception quality, an outdoor antenna may improve the quality.

### Connecting the supplied AM loop antenna

The supplied AM loop antenna is for indoor use only.

Set it in the direction and position it to where you receive the clearest sound. Put it as far away as possible from the unit, televisions, speaker cables, and power cords.

If you experience poor reception quality, an outdoor antenna may improve the quality.

1. Press and hold down the lever of the AM antenna terminal.
2. Insert the bare wire into the antenna terminal.
3. Release the lever.

## CONNECTING AN FM OUTDOOR ANTENNA

### Notes:

- Keep the antenna away from noise sources (neon signs, busy roads, etc.).
- Do not put the antenna close to power lines. Keep it well away from power lines, transformers, etc.
- To avoid the risk of lightning and electrical shock, grounding is necessary.

## CONNECTING AN AM OUTDOOR ANTENNA

An outdoor antenna will be more effective if it is stretched horizontally above a window or outside.

### Notes:

- Do not remove the AM loop antenna.
- To avoid the risk of lightning and electrical shock, grounding is necessary.

# SETUP

After all components are connected, initial setup must be performed.

## ON SCREEN DISPLAY MENU SYSTEM

The SR6400 incorporates an on-screen menu system, which makes various operations possible by using the cursor (▲, ▼, ◀, ▶) and **OK** buttons on the remote control or **MULTI FUNCTION** dial, **TUNING** ◀ / ▶ button and **ENTER** button on the front panel. Use the **MULTI FUNCTION** dial the same as the Up/Down button on the remote, **TUNING** ◀ / ▶ button the same as the Left/Right button on the remote, the **ENTER** button the same as the **OK** button on the remote.

**Notes:**

- To view the on-screen displays, make certain you have made a connection from the Monitor Out jack (VIDEO or S-VIDEO ) on the rear panel to the composite, S-Video input of your TV or projector. (see 12 page)

- Select the **AMP** mode on the remote control.
- Press the **SETUP** button on the remote control to display the "SETUP MAIN MENU" of the OSD menu system. There are 7 items in the SETUP MAIN MENU.

- If you enter this menu from the MULTI dial on the front panel. Press **SELECT** to show the "SETUP MENU" in the FL display and press the **ENTER** button. Select a desired sub-menu with the ▲ or ▼ cursor buttons, and press the **OK** button to enter. The display will change to the selected sub-menu. You can lock the condition of setup to each sub-menu with the ◀ or ▶ cursor buttons.

- If you desire to adjust any sub-menu, you need to set it to UNLOCKED. If you desire to exit from this menu system, press the **EXIT** button (or **SELECT** button on the front panel), or move the cursor to **EXIT** and press the **OK** button.

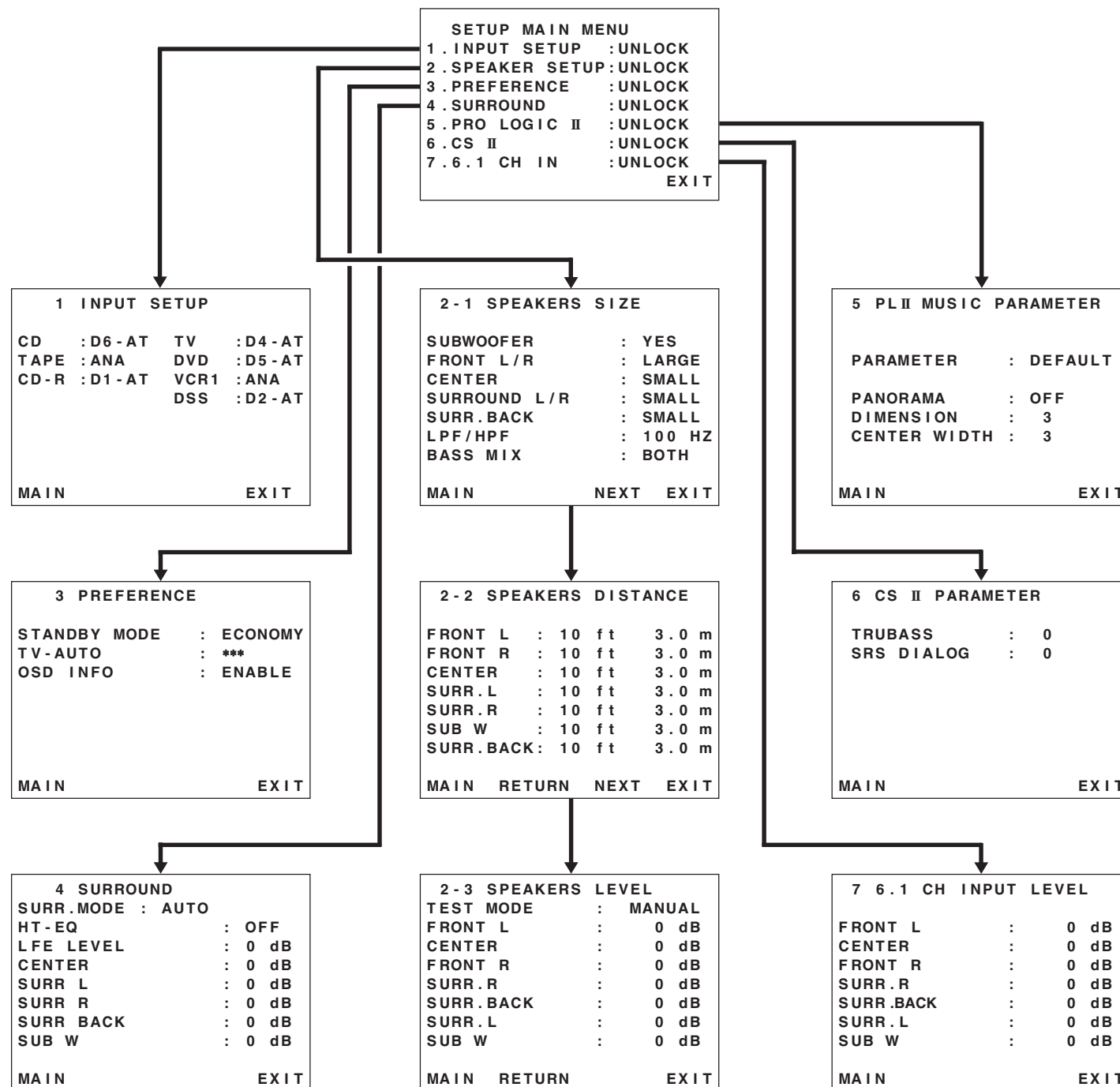

## 1 INPUT SETUP (ASSIGNABLE DIGITAL INPUT)

Six digital inputs can be assigned to a the desired source.

Use this menu to select the digital input jack to be assigned to the input source.

1. Select "INPUT SETUP" in SETUP MAIN MENU with ▲ or ▼ cursor button, and press the OK button.

1 INPUT SETUP			
CD	: D6 - AT	TV	: D4 - AT
TAPE	: ANA	DVD	: D5 - AT
CD - R	: D1 - AT	VCR1	: ANA
		DSS	: D2 - AT
MAIN		EXIT	

2. To select the input source, press the ▲ or ▼ cursor buttons.
3. To select the digital input jack , press the ◀ or ▶ cursor buttons.  
Select "Dx-AT" for input sources, for automatic detection of the digital input signal condition. If there is not a digital signal present, but there is an analog signal present, the analog signal will be played.  
Select "Dig x", when only a digital signal will be used. Select "ANA" for input sources for which no digital input jacks are used.
4. After you complete this portion of the set up, move the cursor to MAIN with the ▲ or ▼ cursor buttons and press the OK button.

### Notes:

- The TUNER and AUX are fixed to the analog input, and cannot be selected for any digital input.
- When a DTS-LD or DTS-CD is playing, this setup is not available. This is to avoid noise being generated from the analog input.
- If "Dx-AT" is selected and a DVD, compact disc or LD is fast-forwarded during playback, decoded signals may produce a skipping sound. In such cases, change the setting to DIGITAL.

## 2 SPEAKER SETUP

After you have installed the SR6400, connected all the components, and determined the speaker layout, it is now time to perform the settings in the Speaker Setup menu for the optimum sound acoustics for your environment and speaker layout. Before you perform the following settings, it is important that you first determine the following characteristics:

### 2-1 SPEAKERS SIZE

When setting the speaker size in the SPEAKER SIZE sub-menu, use the guidelines given below.

#### LARGE:

The complete frequency range for the channel you are setting will be output from the speaker.

#### SMALL:

Frequencies of the channel you are setting lower than approx. 100 Hz will be output from the subwoofer.

If the Subwoofer is set to "NONE" and the front speakers are set to "Large," then the sound may be output from both the left and right speakers.

2 - 1 SPEAKERS SIZE	
SUBWOOFER	: YES
FRONT L / R	: LARGE
CENTER	: SMALL
SURROUND L / R	: SMALL
SURR. BACK	: SMALL
L P F / H P F	: 1 0 0 H Z
BASS M I X	: B O T H
MAIN	NEXT EXIT

1. Select "SPEAKER SETUP" in MAIN SETUP MENU with ▲ or ▼ cursor button, and press the OK button.
2. To select the each speaker, press the ▲ or ▼ cursor buttons.
3. To select the setting of each speaker size, press the ◀ or ▶ cursor buttons.
4. After you complete this portion of the set up, move the cursor to "NEXT" with the ▲ or ▼ cursor buttons and then press the OK button to go to the next page.

### SUBWOOFER:

#### YES:

Select when a subwoofer is connected.

#### NONE:

Select when a subwoofer is not connected.

### FRONT L/R

#### LARGE:

Select if the front speakers are large.

#### SMALL:

Select if the front speakers are small.

- If "NONE" is selected for the Subwoofer setting, then this setting is fixed to "Large."

### CENTER

#### NONE:

Select if no center speaker is connected.

#### LARGE:

Select if the center speaker is large.

#### SMALL:

Select if the center speaker is small.

### SURROUND L/R

#### NONE:

Select if no surround left and right speakers are connected.

#### LARGE:

Select if the surround left and right speakers are large.

#### SMALL:

Select if the surround left and right speakers are small.

### SURR. BACK

#### LARGE:

Select if the surround back speaker is large.

#### SMALL:

Select if the surround back speaker is small.

#### NONE:

Select if no surround back speaker is connected.

- If "None" is selected for the Surround L/R setting, then this setting is not available.

### L P F / H P F

When you use a subwoofer, you can select the cutoff frequency for the small speakers used. Select one of the crossover frequency levels according to the size of the small speaker connected.

#### 80Hz :

Select this when the bass speaker is about 12 cm (4 3/4 inches).

#### 100Hz :

Select this when the bass speaker is about 10 cm (3 15/16 inches).

#### 120Hz :

Select this when the bass speaker is about 8 cm (3 3/16 inches).

### Notes:

- Use the above comments as reference when adjusting.
- If S- Direct mode , 6.1CH Input is in use, this function does not take effect.

### BASS MIX

- The bass mix setting is only valid when "LARGE" is set for the front speakers and "YES" is set for the subwoofer during stereo playback .
- When "BOTH" is selected, the low frequencies will be played through the main L&R, as well as the sub woofer.

In this playback mode, the low frequency range expand more uniformly through the room, but depending on the size and shape of the room, interference may result in a decrease of the actual volume of the low frequency range.

- By selecting "MIX", the low frequencies will play through the main L&R ONLY.

### Note:

LFE signals during playback of Dolby Digital or DTS, will be played through the sub woofer.

## 2-2 SPEAKERS DISTANCE

Use this parameter to specify the distance of each speaker's position from the listening position. The delay time is automatically calculated according to these distances.

Begin by determining the ideal or most commonly used seating position in the room.

This is important for the timing of the acoustics to create the proper sound space that the SR6400 and today's sound systems are able to produce.

Note : For speakers that you have selected "None" the Speaker Configuration sub-menu will not appear here. (There are several useful books and special DVD and LD's available to guide you through proper home theater configuration. If you are unsure, have your Marantz dealer perform the installation for you. They are trained professionals familiar with even the most sophisticated custom installations. Marantz recommends the WWW.CEDIA.ORG website for further information about this).

2 - 2 SPEAKERS DISTANCE			
FRONT L	:	10 ft	3.0 m
FRONT R	:	10 ft	3.0 m
CENTER	:	10 ft	3.0 m
SURR. L	:	10 ft	3.0 m
SURR. R	:	10 ft	3.0 m
SUB W	:	10 ft	3.0 m
SURR. BACK	:	10 ft	3.0 m
MAIN	RETURN	NEXT	EXIT

1. To select each speaker, press the ▲ or ▼ cursor buttons.
2. To set the distance for each speaker, press the ◀ or ▶ cursor buttons.
3. After you complete this portion of the set up, move the cursor to "NEXT" with the ▲ or ▼ cursor buttons and then press the OK button to go to the next page.

### FRONT L :

Set the distance from the front left speaker to your normal listening position between 1 and 30 feet in 1.0 foot intervals (0.3 to 9 meters in 0.3-meter intervals).

### FRONT R :

Set the distance from the front right speaker to your normal listening position between 1 and 30 feet in 1.0 foot intervals (0.3 to 9 meters in 0.3-meter intervals).

### CENTER :

Set the distance from the center speaker to your normal listening position between 1 and 30 feet in 1.0 foot intervals (0.3 to 9 meters in 0.3-meter intervals).

### SURR. L :

Set the distance from the surround left speaker to your normal listening position between 1 and 30 feet in 1.0 foot intervals (0.3 to 9 meters in 0.3-meter intervals).

### SURR. R :

Set the distance from the surround right speaker to your normal listening position between 1 and 30 feet in 1.0 foot intervals (0.3 to 9 meters in 0.3-meter intervals).

### SUB W :

Set the distance from the subwoofer to your normal listening position between 1 and 30 feet in 1.0-foot intervals (0.3 to 9 meters in 0.3-meter intervals).

### SURR. BACK:

Set the distance from a surround back speaker to your normal listening position between 1 and 30 feet in 1.0-foot intervals (0.3 to 9 meters in 0.3-meter intervals).

### Notes

- For the speakers that you have selected "None" the Speaker Size menu will not appear.

## 2-3 SPEAKERS LEVEL

Here you will set the volume for each speaker so that they are all heard by the listener at the same level. We recommend using a SPL (Sound Pressure Level) meter, when available.

### Note:

- The speaker level settings are not available in 6.1 channel input mode and S-Direct mode.

2 - 3 SPEAKERS LEVEL			
TEST MODE	:	MANUAL	
FRONT L	:	0 dB	
CENTER	:	0 dB	
FRONT R	:	0 dB	
SURR. R	:	0 dB	
SURR. BACK	:	0 dB	
SURR. L	:	0 dB	
SUB W	:	0 dB	
MAIN	RETURN		EXIT

### TEST MODE :

Selects "MANUAL" or "AUTO" for generating the mode of the test tone with the ◀ or ▶ cursor buttons.

If you select "AUTO", the test tone will be cycled through in a circular pattern which is Left → Center → Right → Surround Right → Surround Back → Surround Left → Subwoofer → Left →.. increments of 3 seconds for each channel. Using the ◀ or ▶ cursor buttons, adjust the volume level of the noise from the speaker so that it is the same level for all the speakers.

If you select "MANUAL", adjust the output level of each speaker as listed below.

1. When you move the cursor to FRONT L by pressing the ▼ cursor button, the SR6400 will emit a pink noise from the front left speaker. Remember the level of this noise and then press the ▼ cursor button. (Note that this can be adjusted to any level between -10 and +10 dB in 1 dB intervals except the subwoofer setting. The subwoofer can be adjusted to any level between -15 and +10 dB in 1 dB intervals.) The SR6400 will now emit the pink noise from the center speaker.
2. Using the ◀ and ▶ cursor buttons, adjust the volume level of the noise from the center speaker so that it is the same level as the front left speaker.
3. Press the ▼ cursor button again. The SR6400 will now emit the pink noise from the front right speaker.
4. Repeat steps 2 and 3 above for the front right and other speakers until all speakers are adjusted to the same volume level.

After you complete this portion of the set up, press the OK button, the cursor will move to "MAIN" and then press the OK button to go to SETUP MAIN MENU.

### Notes:

- Speakers that you selected "None" for in the Speaker Size menu will not appear.
- To adjust the speaker levels for 6.1-channel input sources, you will need to use the 6.1CH-INPUT sub menu. (See page 18).

## 3 PREFERENCE

3 PREFERENCE	
STANDBY MODE	: ECONOMY
TV - AUTO	: ***
OSD INFO	: ENABLE
MAIN	EXIT

1. Select "PREFERENCE" in the SETUP MAIN MENU with the ▲ or ▼ cursor buttons, and press the OK button.
2. To select a desired content, press the ▲ or ▼ cursor buttons.

### STANDBY MODE:

When this function is set to "ECONOMY", you can reduce the power consumption when the unit is in the standby mode.

### Note:

- TV-AUTO and RS-232C are disabled in the "ECONOMY" setting.

### TV AUTO:

Select the TV AUTO ON/OFF function to enable or disable with the ◀ or ▶ cursor buttons. (refer to page 23)

### OSD Info:

Select the OSD information function to enable or disable with the ◀ or ▶ cursor buttons. If you select "ENABLE", the SR6400 will display the status of the feature (Volume up/down, input select, etc..) on the TV monitor. But if you do not desire this information, select "DISABLE".

After you complete this portion of the set up, move the cursor to "MAIN" with the ▲ or ▼ cursor buttons and press the OK button.

4 SURROUND

4 SURROUND	
SURR.MODE :	AUTO
HT-EQ :	OFF
LFE LEVEL :	0 dB
CENTER :	0 dB
SURR L :	0 dB
SURR R :	0 dB
SURR BACK :	0 dB
SUB W :	0 dB
MAIN :	EXIT

1. Select "SURROUND" in the SETUP MAIN MENU with the ▲ or ▼ cursor buttons, and press the OK button.
2. To select a desired content, press the ▲ or ▼ cursor buttons.

**SURR.MODE :**

Select the desired surround mode with the ◀ or ▶ cursor buttons.

**HT-EQ :**

Select to active the HT-EQ with the ◀ or ▶ cursor buttons.

The tonal balance of a film soundtrack will be excessively bright and harsh when played back over audio equipment in the home. This is because film soundtracks were designed to be played back in large movie theater environments. Activating the HT-EQ feature when watching a film made for movie theaters corrects this and restores the correct tonal balance.

The HT-EQ feature can be activated only while in Dolby Pro Logic Mode, or while decoding Dolby Digital or DTS encoded material.

**LFE LEVEL :**

Select the output level of the LFE signal included in the Dolby Digital signal or the DTS signal. Select 0 dB, -10 dB or OFF with the ◀ or ▶ cursor buttons.

**CHANNEL LEVEL**

**CENTER LEVEL:**

Set the effect level of the center speaker between -10 and +10 dB level in 1 dB level intervals.

- If "None" was selected for the Center speaker setting, in the Speaker size set up menu, then this setting will not appear.

**SURR L LEVEL:**

Set the level of the Surround left speaker between -10 and +10 dB level in 1 dB level intervals.

- If "None" was selected for the Surround left speaker setting, in the Speaker size set up menu, then this setting will not appear.

**SURR R LEVEL:**

Set the level of the Surround right speaker between -10 and +10 dB level in 1dB level intervals.

- If "None" was selected for the Surround right speaker setting, in the Speaker size set up menu, then this setting will not appear.

**SURR BACK LEVEL:**

Set the effect level of the Surround Back speaker between -10 and +10 dB level in 1 dB level intervals.

- If "None" was selected for the Surround back speakers setting, in the Speaker size set up menu, then this setting will not appear.

**SUB W LEVEL:**

Set the effect level of the subwoofer speaker between -15 and +10 dB level in 1 dB level intervals.

- If "None" was selected for the Subwoofer speaker setting, in the Speaker size set up menu, then this setting will not appear.

After you complete this portion of the set up, move the cursor to "MAIN" with the ▲ or ▼ cursor buttons and press the OK button.

5 PL II (PRO LOGIC II) MUSIC PARAMETER

Pro Logic II-Music mode creates a rich and enveloping surround ambience from stereo sources such as CDs. In this mode, SR6400 includes three controls to fine-tune the soundfield as follows.

5 PL II MUSIC PARAMETER	
PARAMETER :	DEFAULT
PANORAMA :	OFF
DIMENSION :	3
CENTER WIDTH :	3
MAIN :	EXIT

Select "PRO LOGIC II" in the SETUP MAIN MENU with the ▲ or ▼ cursor buttons, and press the OK button.

**PARAMETER:**

Select "DEFAULT" or "CUSTOM" with the ◀ or ▶ cursor buttons. If you select "CUSTOM", you can adjust three parameters as listed below.

**PANORAMA:**

Select the Panorama mode On or Off with the ◀ or ▶ cursor buttons. Panorama wraps the sound of the front left and right speakers around you, for an exciting perspective.

**DIMENSION:**

Set the Dimension level between 0 and 6 level in 1 level intervals with the ◀ or ▶ cursor buttons. Adjust the soundfield either towards the front or towards the rear.

This can be useful to help achieve a more suitable balance from all the speakers with certain recordings.

**CENTER WIDTH:**

Set the Center width level between 0 and 7 in 1 level intervals with the ◀ or ▶ cursor buttons. Center Width allows you to gradually spread the center channel sound into the front left and right speakers.

At its widest setting, all the sound from the center is mixed into the left and right.

This control may help achieve a more spacious sound or a better blend for the front image.

If "None" was selected for the Center speaker setting, in the Speaker size set up menu, then this setting will not appear.

After you complete this portion of the set up, move cursor to "MAIN" with the ▲ or ▼ cursor buttons and press the OK button.

6 CS II (CIRCLE SURROUND II) PARAMETER

6 CS II PARAMETER	
TRUBASS :	0
SRS DIALOG :	0
MAIN :	EXIT

1. Select "CS II" in the SETUP MAIN MENU with the ▲ or ▼ cursor buttons, and press the OK button.
2. To Select desired contents as below, press the ▲ or ▼ cursor buttons.

**TRUBASS:**

Set the TRUBASS level between 0 and 6 level in 1 level interval with the ◀ or ▶ cursor buttons. TRUBASS produced by the speakers are an octave below the actual physical capabilities of the speakers adding exciting, deeper bass effects.

**SRS DIALOG:**

Set the SRS DIALOG level between 0 and 6 in 1 level intervals with the ◀ or ▶ cursor buttons.

This can be popped out of the surround audio effects, allowing the listener to easily discern what the actors say.

If "NONE" was selected for the Center speaker setting, in the Speaker size set up menu, then this setting will not appear.

After you complete this portion of the set up, move cursor to "MAIN" with the ▲ or ▼ cursor buttons and press the OK button.

7 6.1 CH INPUT LEVEL

This sub-menu is to adjust the speaker levels for 6.1-channel input sources.

Here you will adjust the volume for each channel so that they are all heard by the listener at the same level.

7 6.1 CH INPUT LEVEL	
FRONT L :	0 dB
CENTER :	0 dB
FRONT R :	0 dB
SURR . R :	0 dB
SURR .BACK :	0 dB
SURR . L :	0 dB
SUB W :	0 dB
MAIN :	EXIT

1. Select "6.1CH IN" in the MAIN SETUP MENU with the ▲ or ▼ cursor buttons, and press the OK button.
2. To Select desired channel, press the ▲ or ▼ cursor buttons.
3. Using the ◀ or ▶ cursor buttons, adjust the volume level of each channel.
4. After you complete this portion of the set up, move the cursor to "MAIN" with the ▲ or ▼ cursor buttons and press the OK button.

**Note:**

- These settings will be memorized to 6.1CH INPUT source.

# BASIC OPERATION

## (PLAY BACK)

### SELECTING AN INPUT SOURCE.

Before you can listen to any input media, you must first select the input source on the SR6400.

**Example : DVD**

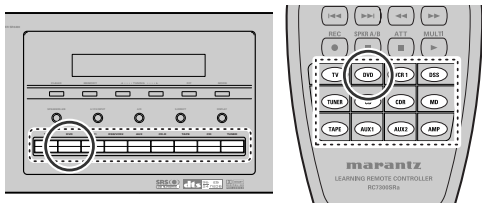

To select DVD, simply press the **DVD** button on the front panel or press the **DVD** button on the remote. After you have selected DVD, simply turn on the DVD player and play the DVD.

- As the input source is changed, the new input name will appear momentarily on the video display. The input name will also appear in the display, on the front-panel.
- As the input is changed, the SR6400 will automatically switch to the digital input, surround mode, attenuation, and night mode status which were entered during the configuration process for that source.
- When an audio source is selected, the last video input used remains routed to the **VCR1 & DSS/ VCR2** Outputs and **Monitor** Outputs. This permits simultaneous viewing and listening to different sources.
- When a Video source is selected, the video signal for that input will be routed to the **Monitor Outputs** jacks and will be viewable on a TV monitor connected to the SR6400. If a component video input is connected to the **DVD** or **DSS** component inputs, it will be routed to the **Component Video Output**. Make certain that your TV is set to the proper input to view the signal.

### SELECTING THE SURROUND MODE

**Example : AUTO SURROUND**

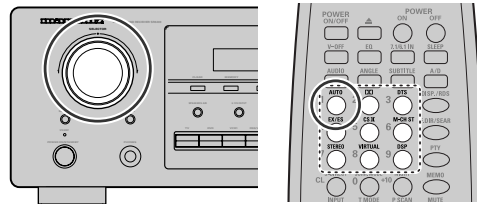

To select the surround mode during playback, turn the **SELECT** knob on the front panel or press the surround mode button on the remote .

### ADJUSTING THE MAIN VOLUME

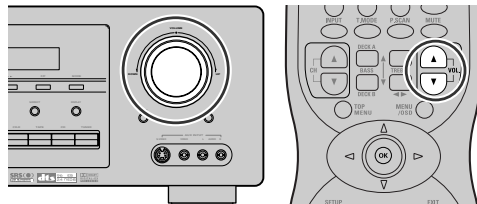

Adjust the volume to a comfortable level using the **VOLUME** control knob on the front panel or **VOL ▲ / ▼** buttons on the remote.

To increase the volume, turn the **VOLUME** knob clockwise or press **VOL ▲** button on the remote, to decrease the volume, turn counterclockwise or press **VOL ▼** button on the remote.

#### Notes:

- The volume can be adjusted within the range of  $-\infty$  to 18 dB, in steps of 1 dB.
- However, when the channel level is set as described on page 17, if the volume for any channel is set at +1 dB or greater, the volume cannot be adjusted up to 18 dB.

(In this case the maximum volume adjustment range is "18 dB - Maximum value of channel level)

### ADJUSTING THE TONE (BASS & TREBLE) CONTROL.

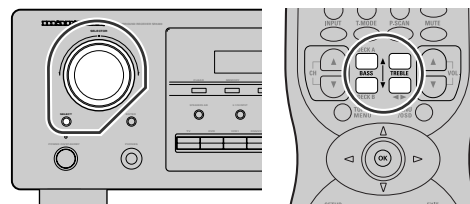

During a listening session you may wish to adjust the Bass and Treble Control to suit your listening tastes or room acoustics.

#### (Using the SR6400)

To change the selector mode , press the **SELECT** button, until "BASS" or "TREBLE" is shown on the front display.

Turn the **SELECTOR** knob to the desired level of tone control.

#### (Using the remote control unit)

To adjust the bass effect , press **BASS▲** or **BASS▼** on the remote.

To adjust the treble effect , press **TREBLE▲** or **TREBLE▼** on the remote.

#### Notes :

- The tone control function can work in the AUTO Surround, Stereo, Dolby PL2, DTS, DTS-ES, and Multi Ch. Stereo mode.

### TEMPORARILY TURNING OFF THE SOUND

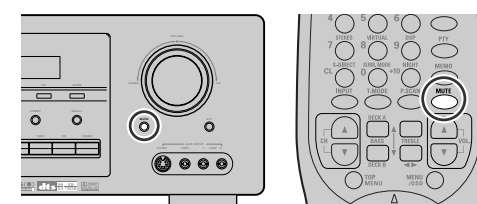

To temporarily silence all speaker outputs such as when interrupted by a phone call, press the **MUTE** button on the front panel or **MUTE** button on the remote.

This will interrupt the output to all speakers and the head-phone jack, but it will not affect any recording or dubbing that may be in progress.

When the system is muted, the display will show "MUTE" .

Press the **MUTE** button again to return to normal operation.

## USING THE SLEEP TIMER

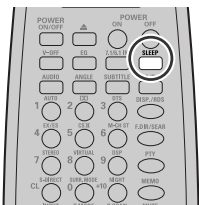

To program the SR6400 for automatic standby, press the **SLEEP** button on the remote. Each press of the button will increase the time before shut down in the following sequence.

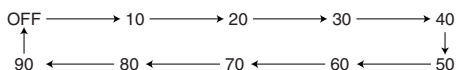

The sleep time will be shown for a few seconds in the display on the front panel, and it will count down until the time has elapsed. When the programmed sleep time has elapsed, the unit will automatically turn off. Note that the **SLEEP** indicator on the display will illuminate when the Sleep function is programmed. To cancel the Sleep function, press the **SLEEP** button until the display shows "**SLEEP OFF**" and the SLEEP indicator will disappear.

## NIGHT MODE

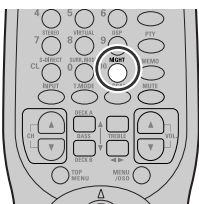

Press the **NIGHT** button on the remote to turn on the NIGHT mode. Selecting the Night Mode ON is effective in Dolby Digital only, and it compresses the dynamic range. This softens loud passages such as sudden explosions, to help prevent disturbing others late at night. To turn off the Night mode, press the **NIGHT** button again.

## SURROUND MODE

The SR6400 is equipped with many surround modes. These are provided to reproduce a variety of surround sound effects, according to the content of the source to be played. The available surround modes may be restricted depending on the input signal and speaker setup.

### AUTO

When this mode is selected, the receiver determines whether the digital input signal is Dolby Digital, Dolby Digital Surround EX, DTS, DTS-ES, DTS 96/24 or PCM-audio.

Surround EX & DTS-ES will operate for multichannel source that has a Dolby Digital Surround EX or DTS-ES auto trigger flag in the digital signal.

When a Dolby Digital or DTS signal is input, the number of channels for which the corresponding signal is encoded will be played. Inputting a Dolby Digital two channel signal with Dolby surround status automatically subjects that signal to Pro Logic II movie processing before play. PCM 96 kHz source material can be played in this mode.

### Notes:

- When you use this mode with certain DVD and CD players, performing operations such as "Skip" or "Stop" may momentarily interrupt the output.
- When the signal is not decoded, the mode is changed to AUTO mode automatically. Refer to page 22 to confirm the available decoding mode.

### DD MODE

(Dolby Digital, Pro Logic II MOVIE, Pro Logic II MUSIC, Pro Logic)

This mode is used with source materials encoded in Dolby Digital and Dolby Surround.

### DOLBY DIGITAL

This mode is enabled when playing source materials encoded in Dolby Digital. Playing multichannel encoded 5.1-channel Dolby Digital sources provides five main audio channels (left, center, right, surround left and surround right) and Low Frequency Effect channel. Dolby Digital EX decoding is not available in this mode.

Dolby Pro Logic II brings the excitement of surround sound to any stereo mix, while making existing Dolby Surround mixes sound more like discrete 5.1 channels Surround sound.

Dolby Pro Logic II has 3 modes. Please see below.

### Pro Logic II MOVIE

This mode provides 5.1 channel surround sound from Dolby Surround encoded stereo movie sound tracks.

### Pro Logic II MUSIC

This mode provides 5.1 channel surround sound from conventional stereo sources, analog or digital, such as CD, Tape, FM, TV, Stereo VCR, etc.

### Pro Logic

This mode emulated original Dolby Pro Logic decoding (3/1 surround) suit for Dolby Surround encoded stereo movie soundtracks.

### Notes:

- Pro Logic II mode is available for a 2ch input signal which is encoded in Dolby Digital or PCM format.
- PCM-audio signals can be subjected to Pro Logic processing when the sampling frequency is 32 kHz, 44.1 kHz or 48 kHz.

### EX/ES

This mode provides 6.1 channel surround for DOLBY DIGITAL EX, DTS-ES encoded source material such as DVD.

This mode cannot be used when an analog input has been selected.

### Dolby Digital EX

In a movie theater, film soundtracks that have been encoded with Dolby Digital surround EX technology are able to reproduce an extra channel which has been added during the mixing of the program.

This channel, called Surround Back, places sounds behind the listener in addition to the currently available front left, front center, front right, surround right, surround left and subwoofer channels.

This additional channel provides the opportunity for more detailed imaging behind the listener and brings more depth, spacious ambience and sound localization than ever before.

Dolby Digital EX is not available in the system

without surround back speaker(s).

### DTS-ES (Discrete 6.1, Matrix 6.1)

DTS-ES adds the surround center channel audio to the DTS 5.1-channel format to improve the acoustic positioning and makes acoustic image movement more natural with the 6.1-channel reproduction.

This receiver incorporates a DTS-ES decoder, which can handle DTS-ES Discrete-encoded and DTS-ES Matrix-encoded program sources from DVD, etc..

DTS-ES Discrete 6.1 features digital discrete recording of all channels including the surround back channel(s) and higher quality of audio reproduction. DTS-ES is not available in the system without a surround back speaker.

### dts MODE

(dts, Neo:6 Cinema, Neo:6 Music)

This mode is for DTS encoded source materials such as LASER DISC, CD, and DVD. Neo:6 is for some 2 channel sources.

**dts** : This mode is enabled when playing source materials encoded in dts multichannel.

Playing multichannel encoded 5.1-channel dts sources provides five main audio channels (left, center, right, surround left and surround right) and Low Frequency Effect channel.

dts-ES decoding is not available in this mode.

The DTS mode cannot be used when an analog input has been selected.

### Neo:6 Cinema, Neo:6 Music

This mode decodes 2-channel signals into 6-channel signals using high-accuracy digital matrix technology.

The DTS NEO:6 decoder has near-discrete properties in the frequency characteristics of the channels as well as in channel separation.

According to the signals to be played back, DTS NEO:6 uses either the NEO:6 CINEMA mode optimized for movie playback or the NEO:6 MUSIC mode optimized for music playback.

### Note:

- Neo:6 mode is available to 2ch input signals which are encoded in Dolby Digital or PCM format.
- PCM-audio signals can be subjected to Pro Logic processing when the sampling frequency is 32

kHz, 44.1 kHz or 48 kHz.

### **MULTI CH. ST**

This mode is used to create a wider, deeper and more natural soundstage from two channel source material. This is done by feeding the left channel signal to both left front and left surround speaker and the right channel signal to both right front and right surround speaker. Additionally, the center channel reproduces a mix of the right and left channel.

### **CIRCLE SURROUND II (CSII-CINEMA, CSII-MUSIC, CSII-MONO)**

Circle Surround is designed to enable multichannel surround sound playback of non-encoded and multichannel encoded material.

Backward compatibility provides listeners with up to 6.1 channels of surround performance from entire collection of music and film, including broadcast, videotape and stereo recorded music.

Depending on source material, you can select **CSII-Cinema** mode, **CSII-Music** mode or **CSII-Mono** mode.

#### **Note:**

- CS II mode is available for 2ch input signals which are encoded in Dolby Digital or PCM format.
- PCM-audio signals can be subjected to Pro Logic processing when the sampling frequency is 32 kHz, 44.1 kHz or 48 kHz.

### **VIRTUAL**

This mode creates a virtualized surround sound experience from a two-speaker (front L and R) playback system playing any multichannel audio source (such as found on DVDs and digital broadcasts), including Dolby Digital, Dolby Pro Logic or DTS.

### **STEREO**

This mode bypasses all surround processing. In stereo program sources, the left and right channels play normally when PCM-audio or analog stereo is input.

With Dolby Digital and DTS sources, the 5.1 multichannels are converted to two channel stereo. 96 kHz PCM source material can be played

back in stereo mode.

### **S (SOURCE) - DIRECT**

In the source direct mode, the tone control circuit and bass management configuration are bypassed for full range frequency response and the purist audio reproduction.

96 kHz PCM source material can be played back in this mode.

#### **Notes:**

- Internal speaker size is setup to front L/R = Large, Center = Large, Surround L/R = Large and Subwoofer = Yes automatically. Tone controls and additional processing are also defeated.
- When you use this mode with certain DVD and CD players, performing operations such as "Skip" or "Stop" may momentarily interrupt the output.

### **CAUTION**

#### **NOTE for DTS signal**

- \* Connected DVD-player, laser-disc player or CD-player needs to support DTS-digital output. You may not be able to play some DTS source signals from certain CD players and LD players even if you connect the player to the SR6400 digitally. This is because the digital signal has been processed (such as the output level, sampling frequency, or frequency response) and the SR6400 cannot recognize the signal as DTS data.
- \* Depending on the player used, DTS play may produce a short noise. This is not a malfunction.
- \* While signals from DTS-laser disc or CD are playing in another Surround mode, you cannot switch to digital input or from digital input to analog input by INPUT SETUP in SETUP MAIN MENU or the A/D button.
- \* The outputs for the VCR 1 OUT, DSS/VCR 2 OUT, TAPE OUT, and CD-R OUT output analog audio signals. Do not record from CDs or LDs that support DTS using these outputs. If you do, the DTS-encoded signal will be recorded as noise.

#### **NOTE for Dolby Digital Surround EX signal**

- \* When playing Dolby Digital Surround EX-encoded software in 6.1 channels, it is required to set the EX/ES mode.
- \* Note that some of Dolby Digital Surround EX-encoded software does not contain the

identification signal. In this case, set the EX/ES mode manually.

#### **NOTE for 96kHz PCM audio**

- \* AUTO, Source- DIRECT, and STEREO modes can be used when playing PCM signals with a sampling frequency of 96 kHz (such as from DVD-Video discs that contain 24 bit, 96 kHz audio). If such signals are input during playback in one of the other surround modes, output from SR6400 will be muted.
- \* Certain DVD player models inhibit digital output. For details, refer to the player's operation manual.
- \* Some DVD formatted discs feature copy protection. When using such disc, 96 kHz PCM signal is not output from the DVD player. For details, refer to the player's operation manual.



**The relation between the selected surround mode and the input signal**

The surround mode is selected with the surround mode selector on SR6400 or the remote control unit. However, the sound you hear is subject to the relationship between the selected surround mode and input signal. That relationship is as follows;

Surround Mode	Input Signal	Decoding	Output Channel					Front information display	
			L/R	C	SL SR	SB	SubW	Signal format indicators	Channel status
AUTO	Dolby Surr. EX	Dolby Digital EX	○	○	○	○	○	DD DIGITAL	L, C, R, SL, SR, S, LFE
	Dolby D (5.1ch)	Dolby Digital 5.1	○	○	○	-	○	DD DIGITAL	L, C, R, SL, SR, LFE
	Dolby D(2ch)	Dolby Digital 2.0	○	-	-	-	-	DD DIGITAL	L, R
	Dolby D (2ch Surr)	Pro Logic II movie	○	○	○	-	-	DD DIGITAL , DD SURROUND	L, R, S
	DTS-ES	DTS-ES	○	○	○	○	○	dtS , ES	L, C, R, SL, SR, S, LFE
	DTS 96/24	DTS 96/24	○	○	○	-	○	dtS 96/24	L, C, R, SL, SR, LFE
	DTS (5.1ch)	DTS 5.1	○	○	○	-	○	dtS	L, C, R, SL, SR, LFE
	PCM(Audio)	PCM (Stereo)	○	-	-	-	-	PCM	L, R
	PCM 96kHz	PCM (96kHz Stereo)	○	-	-	-	-	PCM	L, R
	Analog	Stereo	○	-	-	-	-	ANALOG	-
S-DIRECT	Dolby D Surr. EX	Dolby Digital EX	○	○	○	○	○	DD DIGITAL	L, C, R, SL, SR, S, LFE
	Dolby D (5.1ch)	Dolby Digital 5.1	○	○	○	-	○	DD DIGITAL	L, C, R, SL, SR, LFE
	Dolby D (2ch)	Dolby Digital 2.0	○	-	-	-	-	DD DIGITAL	L, R
	Dolby D (2ch Surr)	Pro Logic II movie	○	○	○	-	-	DD DIGITAL , DD SURROUND	L, R, S
	DTS-ES	DTS-ES	○	○	○	○	○	dtS , ES	L, C, R, SL, SR, S, LFE
	DTS 96/24	DTS 96/24	○	○	○	-	○	dtS 96/24	L, C, R, SL, SR, LFE
	DTS (5.1ch)	DTS 5.1	○	○	○	-	○	dtS	L, C, R, SL, SR, LFE
	PCM (Audio)	PCM (Stereo)	○	-	-	-	-	PCM	L, R
	PCM 96kHz	PCM (96kHz Stereo)	○	-	-	-	-	PCM	L, R
	Analog	Stereo	○	-	-	-	-	ANALOG	-
EX/ES	Dolby D Surr. EX	Dolby Digital EX	○	○	○	○	○	DD DIGITAL	L, C, R, SL, SR, S, LFE
	Dolby D (5.1ch)	Dolby Digital EX	○	○	○	○	○	DD DIGITAL	L, C, R, SL, SR, LFE
	DTS-ES	DTS-ES	○	○	○	○	○	dtS , ES	L, C, R, SL, SR, S, LFE
	DTS(5.1ch)	DTS-ES	○	○	○	○	○	dtS	L, C, R, SL, SR, LFE
DOLBY (PL II movie) (PL II music) (Pro Logic)	Dolby D Surr. EX	Dolby Digital 5.1	○	○	○	-	○	DD DIGITAL	L, C, R, SL, SR, S, LFE
	Dolby D (5.1ch)	Dolby Digital 5.1	○	○	○	-	○	DD DIGITAL	L, C, R, SL, SR, LFE
	Dolby D (2ch)	Pro Logic II	○	○	○	-	-	DD DIGITAL	L, R
	Dolby D (2ch Surr)	Pro Logic II	○	○	○	-	-	DD DIGITAL , DD SURROUND	L, R, S
	PCM (Audio)	Pro Logic II	○	○	○	-	-	PCM	L, R
	Analog	Pro Logic II	○	○	○	-	-	ANALOG	-
DTS (Neo:6 Cinema) (Neo:6 Music)	DTS-ES	DTS 5.1	○	○	○	-	○	dtS , ES	L, C, R, SL, SR, S, LFE
	DTS 96/24	DTS 96/24	○	○	○	-	○	dtS 96/24	L, C, R, SL, SR, LFE
	DTS (5.1ch)	DTS 5.1	○	○	○	-	○	dtS	L, C, R, SL, SR, LFE
	PCM (Audio)	Neo:6	○	○	○	○	-	PCM	L, R
	Analog	Neo:6	○	○	○	○	-	ANALOG	-
	Dolby D (2ch)	Neo:6	○	○	○	○	-	DD DIGITAL	L, R
CS II Cinema CS II Music CS II Mono	Dolby D (2ch Surr)	Neo:6	○	○	○	○	-	DD DIGITAL , DD SURROUND	L, R, S
	PCM (Audio)	CS II	○	○	○	○	○	PCM	L, R
	Analog	CS II	○	○	○	○	○	ANALOG	-
	Dolby D (2ch)	CS II	○	○	○	○	○	DD DIGITAL	L, R
STEREO	Dolby D (2ch Surr)	CS II	○	○	○	○	○	DD DIGITAL , DD SURROUND	L, R, S
	Dolby Surr. EX	Stereo	○	-	-	-	○	DD DIGITAL	L, C, R, SL, SR, S, LFE
	Dolby D (5.1ch)	Stereo	○	-	-	-	○	DD DIGITAL	L, C, R, SL, SR, LFE
	Dolby D (2ch)	Stereo	○	-	-	-	-	DD DIGITAL	L, R
	Dolby D (2ch Surr)	Stereo	○	-	-	-	-	DD DIGITAL , DD SURROUND	L, R, S
	DTS-ES	Stereo	○	-	-	-	○	dtS , ES	L, C, R, SL, SR, S, LFE
	DTS 96/24	Stereo	○	-	-	-	○	dtS 96/24	L, C, R, SL, SR, LFE
	DTS (5.1ch)	Stereo	○	-	-	-	○	dtS	L, C, R, SL, SR, LFE
	PCM (Audio)	Stereo	○	-	-	-	-	PCM	L, R
	PCM 96kHz	Stereo	○	-	-	-	-	PCM	L, R
Virtual	Analog	Stereo	○	-	-	-	-	ANALOG	-
	Dolby Surr. EX	Virtual	○	-	-	-	-	DD DIGITAL	L, C, R, SL, SR, S, LFE
	Dolby D (5.1ch)	Virtual	○	-	-	-	-	DD DIGITAL	L, C, R, SL, SR, LFE
	Dolby D (2ch)	Virtual	○	-	-	-	-	DD DIGITAL	L, R
	Dolby D (2ch Surr)	Virtual	○	-	-	-	-	DD DIGITAL , DD SURROUND	L, R, S
	DTS-ES	Virtual	○	-	-	-	-	dtS , ES	L, C, R, SL, SR, S, LFE
	DTS (5.1ch)	Virtual	○	-	-	-	-	dtS	L, C, R, SL, SR, LFE
Multi Ch. Stereo	PCM (Audio)	Virtual	○	-	-	-	-	PCM	L, R
	Analog	Virtual	○	-	-	-	-	ANALOG	-
	Dolby Surr. EX	Dolby Digital EX	○	○	○	○	○	DD DIGITAL	L, C, R, SL, SR, S, LFE
	Dolby D (5.1ch)	Dolby Digital 5.1	○	○	○	-	○	DD DIGITAL	L, C, R, SL, SR, LFE
	Dolby D (2ch)	Multi Channel Stereo	○	○	○	○	-	DD DIGITAL	L, R
	Dolby D (2ch Surr)	Multi Channel Stereo	○	○	○	○	-	DD DIGITAL , DD SURROUND	L, R, S
	DTS-ES	DTS-ES	○	○	○	○	○	dtS , ES	L, C, R, SL, SR, S, LFE
DTS (5.1ch)	DTS 5.1	○	○	○	-	○	dtS	L, C, R, SL, SR, LFE	
Stereo	PCM (Audio)	Multi Channel Stereo	○	○	○	○	-	PCM	L, R
	Analog	Multi Channel Stereo	○	○	○	○	-	ANALOG	-

**Note:**

- Dolby Digital (2 ch: Lt/Rt): signal with Dolby Surround flag Speakers are full set.
- No sound outputs from the surround speaker, center speaker and subwoofer if the DVD disc has no surround data.

**Abbreviations**

- L/R : Front speakers
- C : Center speaker
- SL/SR : Surround speakers
- SB : Surround Back speaker
- SubW : Sub woofer speaker

## OTHER FUNCTION

### TV AUTO ON/OFF FUNCTION

This function allows the component connected to the TV-VIDEO in jack to control the power (ON/OFF) to the SR6400.

#### AUTO POWER ON

1. Be sure the TV auto mode is ENABLED. (Refer page 17 : System Setup)
2. Connect your TV TUNER (etc) to the TV-VIDEO in terminal. Be sure to connect the VIDEO input.
3. Turn OFF the power to the TV TUNER and the SR6400.
4. Turn ON the TV TUNER and tune in a receivable station.
5. When the station is received, the SR6400 turns ON and TV is selected automatically.

#### AUTO POWER OFF

1. In the above situation, turn the TV TUNER OFF or select a channel that does not contain any broadcast.
2. The power to the SR6400 switches to STANDBY after approx. 5 minutes.

#### Notes:

- AUTO POWER OFF is canceled if the SR6400 is set to a source other than TV. The function reactivates when TV is selected again.
- Some TV broadcasts may cause the TV AUTO FUNCTION to turn ON.
- The S-Video terminal does not support "TV AUTO ON/OFF" function.

### ATTENUATION TO ANALOG INPUT SIGNAL

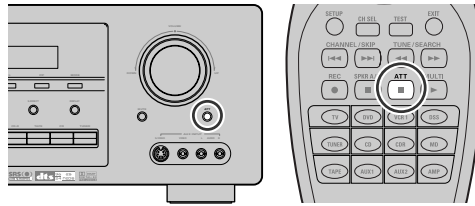

If the selected analog audio input signal is greater than the capable level of internal processing, the "PEAK" indicator will light up on the front display. If this happens, you should press the **ATT** button on the front panel or on the remote. "ATT" indicator will be illuminated when this function is activated. The signal-input level is reduced by about half. Attenuation will not work with the output signal of TAPE-OUT, CD-R/MD-OUT, VCR1-OUT and DSS/VCR2-OUT. This function is memorized for each individual input source.

### LISTENING THROUGH HEADPHONES

This jack may be used to listen to the SR6400's output through a pair of headphones. Be certain that the headphones have a standard 1/4" stereo phono plug. (Note that the speakers will automatically be turned off when the headphone jack is in use.)

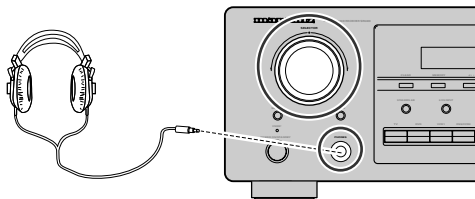

#### Notes:

- When using headphones, the surround mode will change to STEREO and TruSurround (TS) headphones by SURROUND MODE selector.
- The surround mode returns to the previous setting as soon as the plug is removed from the jack.

### VIDEO ON/OFF

When no video signal is connected to the SR6400 or a DVD, etc., is connected directly to your TV, the unnecessary video circuit can be turned off by selecting the "VIDEO OFF" setting. To select video off, press the **V-OFF** on the remote.

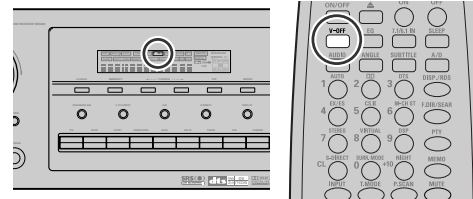

### DISPLAY MODE

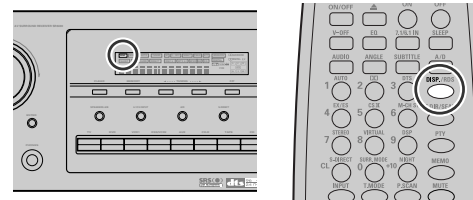

You can select the display mode for the front display of the SR6400.

To select this mode, press the **DISP.** on the remote control. When this button is pressed, the display mode is switched in the following sequence.  
→ Surround Mode → Auto-display Off → Display Off → Input Function → Surround Mode...  
In Auto display off mode, the display is off. But, if you make a change to the unit such as input or surround mode, the display will show that change, then go back to off after about 3 seconds. When changing the volume, it is not displayed. In Display off mode, the display is off completely.

#### Notes:

- Only the DISP indicator will be illuminated on the front display in display off condition

### SELECTING ANALOG AUDIO INPUT OR DIGITAL AUDIO INPUT

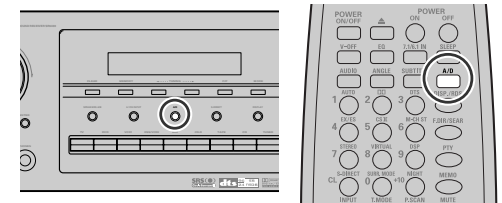

If you have already assigned the digital inputs, you can temporarily select the audio input mode for each input source with the **A/D** button on the remote controller or front panel.

When this button is pressed, the input mode is switched in the following sequence.

→ Digital Auto → Digital → Analog → Digital Auto....

In Digital Auto mode, the types of signals being input to the digital and analog input jacks for the selected input source are detected automatically. If no digital signal is being input, the analog input jacks are selected automatically.

In Digital mode, input is fixed to an assigned digital input terminal.

In analog mode, the analog input jacks are selected. This selecting is temporary, so the result will not be stored in memory.

If you need to change the input mode completely, use SYSTEM SETUP in OSD menu system. (see page 16)

## RECORDING AN ANALOG SOURCE

In normal operation, the audio or video source selected for listening through the SR6400 is sent to the record outputs.

This means that any program you are watching or listening to may be recorded simply by placing machines connected to the outputs for **TAPE OUT**, **CD-R/MD OUT**, **VCR1 OUT**, and **DSS/VCR2 OUT** in the record mode.

*To record the input source signal you are currently watching or listening to*

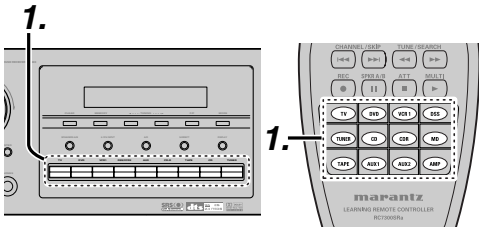

1. Select the input source to record by pressing the corresponding **input selector** button. The input source is now selected and you may watch or listen to it as desired.
2. The currently selected input source signal is output to the **TAPE OUT**, **CD-R/MD OUT**, **VCR1 OUT**, and **DSS/VCR2 OUT** outputs for recording.
3. Start recording to the recording component as desired.

### Recording the video from one source and the audio from another

You can add the sound from one source to the video of another source to make your own video recordings.

Below is an example of recording the sound from a compact disc player connected to CD IN and the video from a video camera connected to AUX IN to video cassette recorder connected to the VCR1 OUT jack.

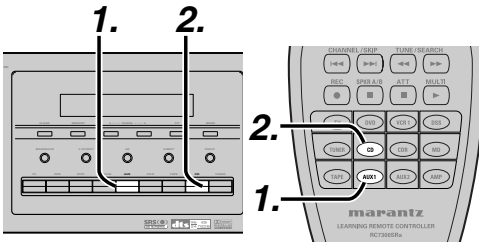

1. Press the **AUX** input source button to set video output.
2. Press the **CD** input source button to set audio output.
3. Now "CD" has been selected as the audio input source and "AUX" as the video input source.

#### Notes:

- If you change the input source during recording, you will record the signals from the newly selected input source.
- You cannot record the surround effects.
- Digital input signals are only output to the digital outputs. There is no conversion from digital to analog.

When connecting CD players and other digital components, do not connect only the digital terminals, but the analog ones as well.

## HT-EQ

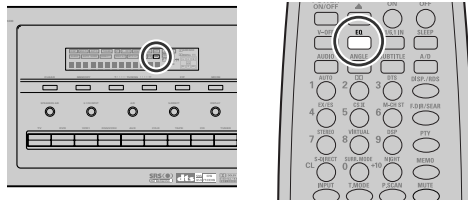

Press the **EQ** button on the remote to turn on the HT-EQ mode.

The tonal balance of a film soundtrack will be excessively bright and harsh when played back over audio equipment in the home. This is because film soundtracks were designed to be played back in large movie theater environments.

Activating the HT-EQ feature when watching a film made for movie theaters corrects this and restores the correct tonal balance.

## SPEAKER A/B

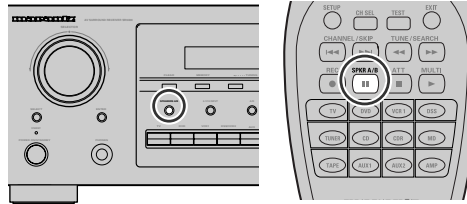

SR6400 has speaker system - A and speaker system-B for front L/R channels.

You can select these systems by pressing **SPEAKERS A/B** button on the front panel or **SPKR A/B** on the remote

## 6.1 CH INPUT.

The SR6400 is equipped for future expansion through the use of Multi channel SACD multichannel player or DVD-Audio player.

When this is selected, the input signals connected to the L(front left), R (front right), CENTER, SL (surround left), SR (surround right) and SB (surround back) channels of the 6.1 CH. In jacks are output directly to the front (left and right), center, surround (left and right) and surround back speaker systems as well as the pre-out jacks without passing through the surround circuitry.

In addition, the signal input to the SW (subwoofer) jack is output to the PRE OUT SW (subwoofer) jack.

When 6.1 CH. INPUT is selected, the last video input used remains routed to the **Monitor Outputs**. This permits simultaneous viewing with video sources.

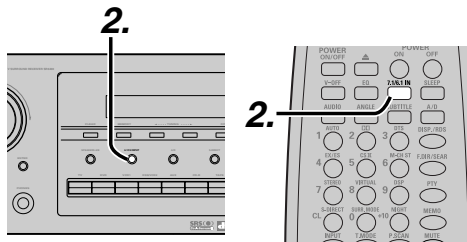

1. Select a desired Video source to decide the routed video signal to the **Monitor Outputs**.
2. Press the **6.1 CH INPUT** button on the front panel or press **7.1/6.1 IN** on the remote to switch the 6.1 channel input.

3. If it is necessary to adjust the output level of each channel, use "6.1 Ch. INPUT LEVEL" in the OSD menu system as desired.

Adjust the speaker output levels so that you can hear the same sound level from each speaker at the listening position. For the front left, front right, center, surround left, surround right and surround back speakers, the output levels can be adjusted between -10 to +10 dB. The subwoofer can be adjusted between -15 and +10 dB.

These adjustments will be stored to 6.1 Ch. INPUT memory. (see to page 18)

4. Adjust the main volume with the **MAIN VOLUME** knob or the **VOL** buttons on the remote.

To cancel the 6.1 Ch. INPUT setting, press the **6.1 CH INPUT** button on the front panel or press **7.1/6.1 IN** on the remote.

#### Notes:

- When the 6.1 Ch. Input is in use, you may not select a surround mode, as the external decoder determines processing.
- In addition, there is no signal at the record outputs when the 6.1 Ch. Input is in use.

# BASIC OPERATION (TUNER)

## LISTENING TO THE TUNER

Frequency scan step for AM is selectable. Default setup is 10 kHz step, if your country's standard is 9 kHz step, Press **TUNER** button on the remote more than 6 seconds. Scan step will change.

### Note:

- Preset memory for the tuner will clear by changing this setup.

## AUTO TUNING

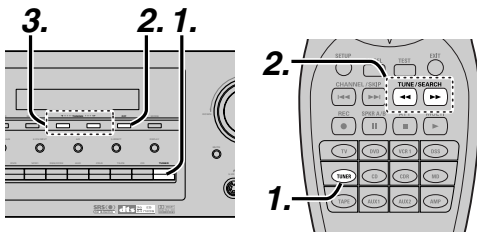

### (Using the SR6400)

1. To select tuner and desired band (FM or AM), press the **TUNER** button on the front panel.
2. **F/P** button on the front panel to display the frequency.
3. Press the **TUNING** ◀ or ▶ button on the front panel for more than 1 second to start the Auto tuning function.
4. Automatic searching begins then stops when a station is tuned in.

### (Using the remote control unit)

1. To select tuner and desired band (FM or AM), press the **TUNER** button twice within in two seconds on the remote.
2. Press the ◀ or ▶ for more than 1 second on the remote.
3. Automatic searching begins then stops when a station is tuned in.

If tuning does not stop at the desired station, use to the "Manual tuning" operation.

## MANUAL TUNING

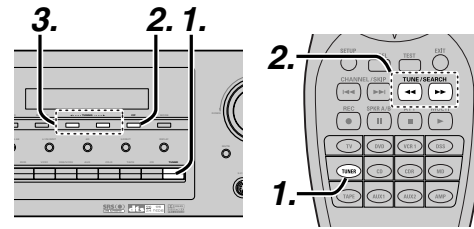

### (Using the SR6400)

1. To select tuner and desired band (FM or AM), press the **TUNER** button on the front panel
2. Press the **F/P (Frequency/Preset)** button on front panel, to have the frequency appear on the display.
3. Press the **TUNING** ◀ or ▶ buttons.

### (Using the remote control unit)

1. To select tuner and desired band (FM or AM), press the **TUNER** button twice within in two seconds on the remote.
2. Press the ◀ or ▶ on the remote to tune in the desired station.

## DIRECT FREQUENCY CALL

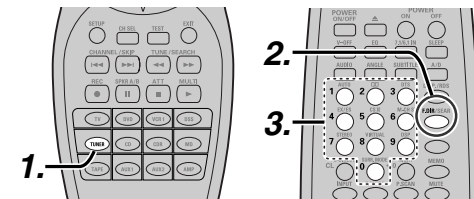

1. To select tuner and desired band (FM or AM), press the **TUNER** button twice within two seconds on the remote.
2. Press the **F.DIR** on the remote, display will show "FREQ - - - -".
3. Input your desired station's frequency with the ten numbered keypad on the remote.
4. The desired station will automatically be tuned.

## (FM) TUNING MODE (AUTO STEREO OR MONO)

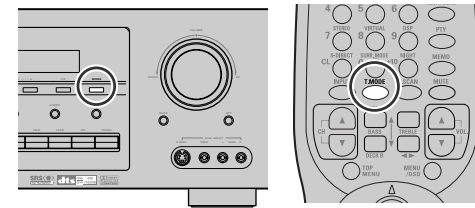

When in the auto stereo mode, **AUTO** indicator will be illuminated on the display.

The "ST" indicator is illuminated when a stereo broadcast is tuned in.

At open frequencies, the noise is muted and the "TUNED" and "ST" indicators are not illuminated. If the signal is weak, it may be difficult to tune into the station in stereo. In such a case, press the **MODE** button on the front panel or press the **T.MODE** button on the remote.

"AUTO" indicator is not illuminated, if FM stereo broadcasts are received in monaural and the "ST" indicator is not illuminated.

To return to auto stereo mode, press the **MODE** button or press **T.MODE** button on the remote again. **AUTO** indicator is illuminated the display.

## PRESET MEMORY

With this unit you can preset up to 50 FM/AM stations in any order.

For each station, you can memorize the frequency and reception mode if desired.

## AUTO PRESET MEMORY

This function automatically scans the FM and AM band and enters all stations with proper signal strength into the memory.

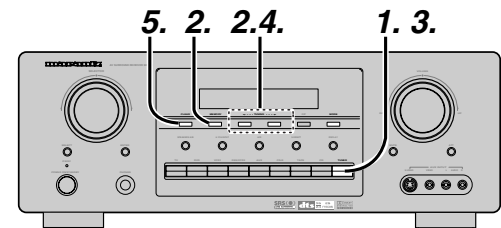

1. To select FM, press the **TUNER** button on the front panel.
2. While pressing the **MEMORY** button, press the **TUNING** ▶ button up. "AUTO PRESET" will appear on the display, and scanning starts from the lowest frequency.
3. Each time the tuner finds a station, scanning will pause and the station will be played for five seconds. During this time, the following operations are possible.
  4. The band can be changed by the **TUNER** button. If no button is pressed during this period, the current station is memorized in location Preset 02.
  5. If you wish to skip the current station, press the **TUNING** ▶ button during this period, this station is skipped and auto presetting continues.
5. Operation stops automatically when all 50 preset memory positions are filled or when auto scanning attains the highest end of all bands. If you desire to stop the auto preset memory at anytime, press the **CLEAR** button.

## MANUAL PRESET MEMORY

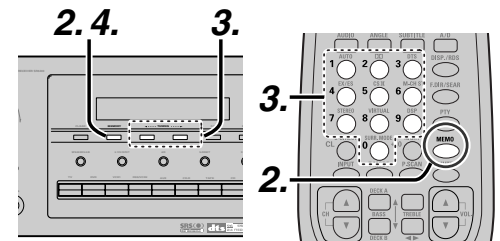

### (Using the SR6400)

1. Tune into the radio station you desire (Refer to the "MANUAL TUNING" or "AUTO TUNING" section).
2. Press the **MEMORY** button on the front panel. " - " (preset number) starts blinking on the display.
3. Select the preset number by pressing the **TUNING** ◀ or ▶ button, while this is still blinking (approx. 5 seconds)
4. Press the **MEMORY** button again to enter. The display stops blinking. The station is now stored in the specified preset memory location.

**(Using the remote control unit)**

1. Tune into the radio station you desire (Refer to the "MANUAL TUNING" or "AUTO TUNING" section).
2. Press the **MEMO** button on the remote. "--" (preset number) starts blinking on the display.
3. Enter the desired preset number by pressing the **numeric** buttons.

**Note:**

- When entering a single digit number (2 for example), either input "02" or just input "2" and wait for a few seconds.

**RECALLING A PRESET STATION**

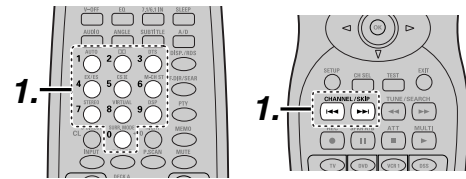
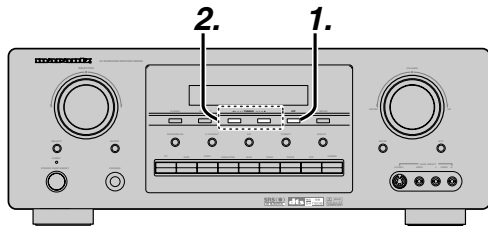

**(Using the SR6400)**

1. Press the **F/P** button to show the preset station on the display.
2. Select the desired preset station by pressing the **TUNING** ◀ or ▶ buttons on the front panel.

**(Using the remote control unit)**

1. Press the ◀ or ▶ buttons to select the desired preset station, or input your desired preset channel with the **numeric** buttons on the remote.

**PRESET SCAN**

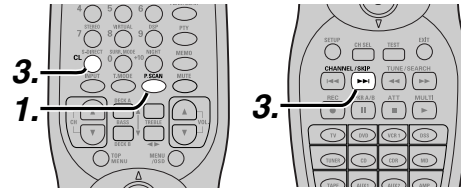

**(Using the remote control unit)**

1. Press the **P.SCAN** on the remote. "PRESET SCAN" appears on the display and then the preset station with the lowest preset number is recalled first.
2. Preset stations are recalled in sequence (No.1 → No.2 → etc.) for 5 seconds each. No stored preset number will be skipped.
3. You can fast forward the preset stations by pressing the ▶▶ continuously. When the desired preset station is received, cancel the preset scan operation by pressing the **CL** button or **P.SCAN** on the remote.

**CLEARING STORED PRESET STATIONS**

You can remove preset stations from the memory using the following procedure.

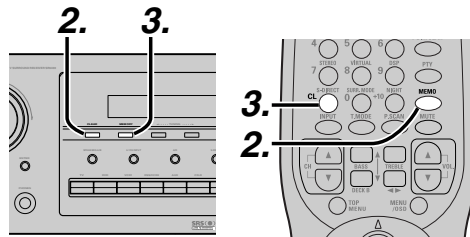

1. Recall the preset number to be cleared with the method described in "Recalling" a preset station.
2. Press the **MEMORY** button on the front panel or press the **MEMO** button on the remote.
3. The stored preset num blinks in the display for 5 seconds. While blinking, press the **CLEAR** button on the front panel or press the **CL** button on the remote.
4. "xx CLEAR" appears on the display to indicate that the specified preset number has been cleared.

**Notes:**

- To clear all stored preset stations, press and hold the **CLEAR** and the **F/P** buttons for two seconds.

**SORTING PRESET STATIONS**

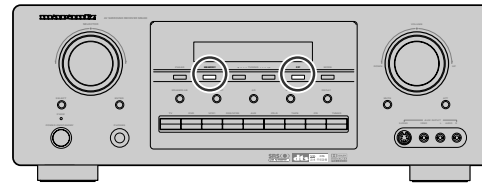

If you have stations memorized, and there is a gap in the sequential order:

I.e. the stations are stored as follows

- 1) 87.1 MHz
- 2) 93.1 MHz
- 3) 94.7 MHz
- 10) 105.9 MHz

(notice there is no stations programmed for pre sets for 4-9), you can have pre set 10 become pre set 5:

To sort the numbers, press and hold the **MEMORY** and the **F/P** buttons.

"PRESET SORT" will appear on the display and sorting will be done.

**NAME INPUT OF THE PRESET STATION.**

This function allows the name of each preset channel to be entered using alphanumeric characters.

Before name inputting, you need to store preset stations with the preset memory operation.

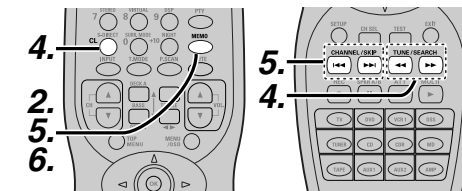
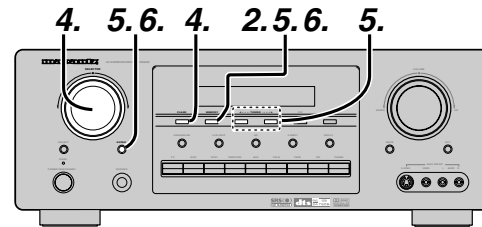

1. Recall the preset number to be inputted name with the method described in "Recalling" a preset station.
2. Press the **MEMORY** button on the front panel or press the **MEMO** button on the remote for more than 3 seconds.

3. The left most column of the station name indicator flashes, indicating the character entry ready status.

4. When the **SELECT** knob is turned or you press the ◀ / ▶ buttons on the remote, alphabetic and numeric characters will be displayed in the following order:

A → B → C ... Z → 1 → 2 → 3 ..... 0 → - → +  
→ / → (Blank) → A  
UP →  
← DOWN

5. After selecting the first character to be entered, press the **MEMORY** or **ENTER** buttons, press the **MEMO** button on the remote.

The entry in this column is fixed and the next column starts to flash. Fill the next column the same way.

To move back and forth between the characters, press the **TUNING** ◀ / ▶ buttons or press the ◀◀ or ▶▶ buttons on the remote.

**Note:**

- Unused columns should be filled by entering blanks.

6. To save the name, press the **MEMORY** or the **ENTER** button, press the **MEMO** button on the remote for more than 2 seconds.

Ten keypad	Press, press again, press again, etc.
1	A → B → C → 1 → A
2	D → E → F → 2 → D
3	G → H → I → 3 → G
4	J → K → L → 4 → J
5	M → N → O → 5 → M
6	P → Q → R → 6 → P
7	S → T → U → 7 → S
8	V → W → X → 8 → V
9	Y → Z → space → 9 → Y
0	- → + → / → 0

# REMOTE CONTROLLER OPERATION

## CONTROLLING MARANTZ COMPONENTS

1. Press the desired function button.
  - The selected function name and USE are displayed in the LCD.
2. Press the desired operation buttons to play the selected component.
  - For details, refer to the component's user guide.
  - It may not be possible to operate some models.

### CONTROLLING A MARANTZ DVD PLAYER (DVD MODE)

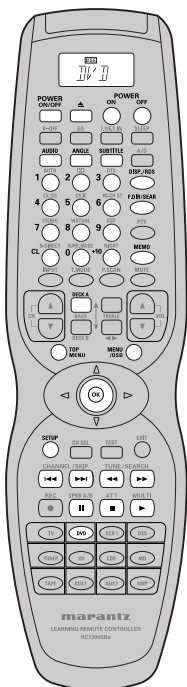

POWER ON/OFF	Turns the DVD player on and off
POWER ON	Turns the DVD player on
POWER OFF	Turns the DVD player off
▲	Opens / closes the disc tray
AUDIO	Selects the audio language
ANGLE	Selects the camera angle
SUBTITLE	Selects the subtitle language
0 - 9,+10	Inputs the numeric #s
DISP	Displays the disc information
F.DIR/SEAR	Searches the title or track
CL	Clears the inputting
MEMO	Calls up programming menu
DECK A	Next disc tray
TOP MENU	Calls up the top menu of the DVD disc
MENU/OSD	Calls up the menu of the DVD disc
Cursor, OK	Moves the cursor, enters the setting
SETUP	Calls up the setup menu of the DVD player
⏮ / ⏭	Skips forward or previous chapter/track
⏪ / ⏩	Searches forward or backward
⏸	Pause
■	Stop
▶	Play

### CONTROLLING A MARANTZ VCR (VCR1 MODE)

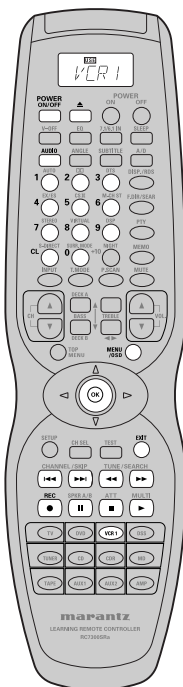

POWER ON/OFF	Turns the VCR on and off
▲	Ejects the tape
AUDIO	Selects the audio language
0 - 9	Inputs the numeric #s
CL	Clears the inputting
MENU/OSD	Calls up the menu
Cursor, OK	Moves the cursor, enters the setting
EXIT	Exits the programming menu
⏮ / ⏭	Skips forward or previous track
⏪ / ⏩	Searches forward or backward
●	Record
⏸	Pause
■	Stop
▶	Play

### CONTROLLING A MARANTZ CD PLAYER (CD MODE)

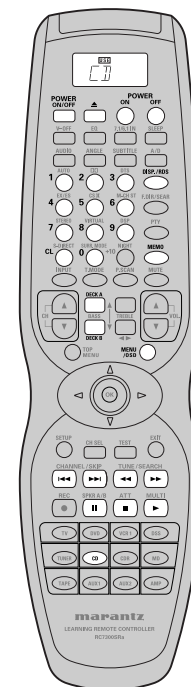

POWER ON/OFF	Turns the CD player on and off
POWER ON	Turns the CD player on
POWER OFF	Turns the CD player off
▲	Opens / closes the disc tray
0 - 9	Inputs the numeric #s
DISP	Scrolls the disc information
CL	Clears the inputting
MEMO	Programs
DECK A, B	Changes the disc tray
MENU/OSD	Switches the display information
⏮ / ⏭	Skips forward or previous track
⏪ / ⏩	Searches forward or backward
⏸	Pause
■	Stop
▶	Play

**CONTROLLING A MARANTZ CD RECORDER (CDR MODE)**

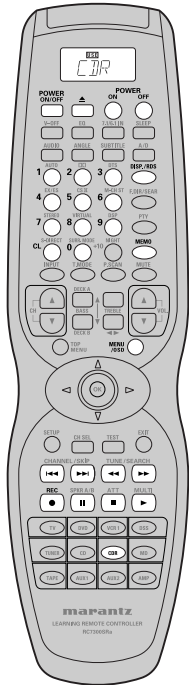

POWER ON/OFF	Turns the CD recorder on and off
POWER ON	Turns the CD recorder on
POWER OFF	Turns the CD recorder off
▲	Opens / closes the disc tray
0 - 9	Inputs the numeric #s
DISP	Switches the display information
CL	Clears the inputting
MEMO	Programs
MENU/OSD	Scrolls the disc information
⏮ / ⏭	Skips forward or previous track
⏪ / ⏩	Searches forward or backward
●	Record
⏸	Pause
■	Stop
▶	Play

**CONTROLLING A MARANTZ MD DECK (MD MODE)**

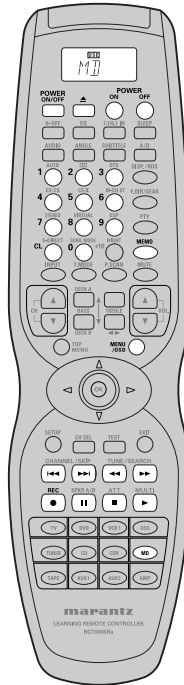

POWER ON/OFF	Turns the MD deck on and off
POWER ON	Turns the MD deck on
POWER OFF	Turns the MD deck off
▲	Eject the MD disc
0 - 9	Inputs the numeric #s
CL	Clears the inputting
MEMO	Programs
MENU/OSD	Switches the display information
⏮ / ⏭	Skips forward or previous track
⏪ / ⏩	Searches forward or backward
●	Record
⏸	Pause
■	Stop
▶	Play

**CONTROLLING A MARANTZ TAPE DECK (TAPE MODE)**

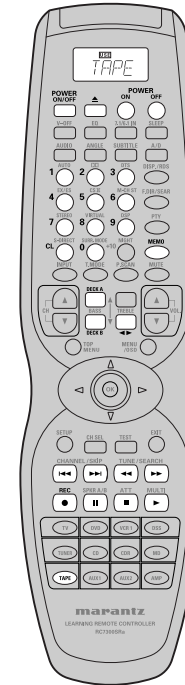

POWER ON/OFF	Turns the tape deck on and off
POWER ON	Turns the tape deck on
POWER OFF	Turns the tape deck off
▲	Eject the tape
0 - 9	Inputs the numeric #s
CL	Clears the inputting
MEMO	Programs
DECK A, B	Changes the tape deck
◀ ▶	Changes the direction
⏮ / ⏭	Skips forward or previous track
⏪ / ⏩	Searches forward or backward
●	Record
⏸	Pause
■	Stop
▶	Play

## LEARN MODE

The remote controll is capable of learning and memorizing the remote control codes used by almost any other remote controll you may already own.

- If no commands have been programmed for a particular function button, the remote controll will transmit whatever codes have been factory preset.
- The following example shows how to program your remote control and how to use the codes for a DVD player.

### LEARNING PROCEDURE

1. Place the remote controll so that its infrared signal transmitter is facing the infrared signal receiver on the Marantz remote controll at a distance of about 5 centimeters.

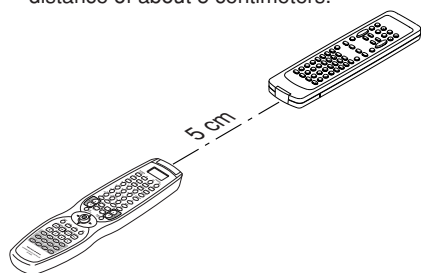

2. Press and hold down the **T.MODE** and **MEMO** buttons until **LEARN** is displayed in the display.

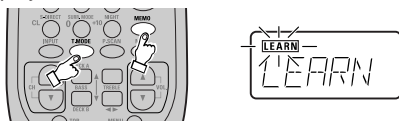

3. Select the **Function** button to select the function.
  - Selected function is displayed and **LEARN** is blinking.

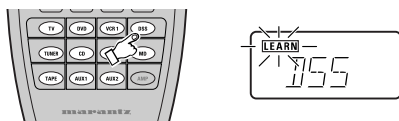

4. Select the button to be learned.
  - **LEARN** is displayed.

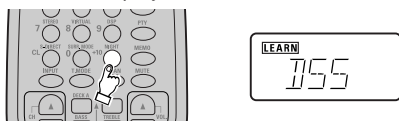

5. Press and hold the button of the original remote control to learn until **OK** is in the display.
  - When **NG** is displayed, repeat this step.
  - When **FULL** is displayed, the memory of the RC7300SRa is full. If you want to learn this code, you should erase another learned button.
6. Repeat steps 4 and 5 to learn the other buttons in the same function.
7. Repeat steps 3 to 6 to learn the other function.
8. When you have finished programming the remote control, press and hold down the **OK** button until **USE** is displayed in the display.

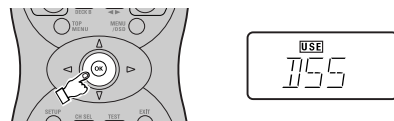

#### Note:

- When **NG** is displayed in step 5 again, the transmitting code is unavailable for RC7300SRa, or the transmitting signal is intercepted by noise.
- If no buttons are pressed for approximately 1 minute while in the **LEARN** mode, the remote controll automatically returns to the use mode.

### ERASING LEARNED CODES

#### Erasing the code by buttons

1. Press and hold down the **T.MODE** and **MEMO** buttons until **LEARN** is displayed in the display.

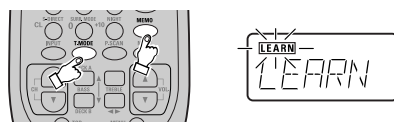

2. Select the **Function** button to be erased.
  - Selected function is displayed and **LEARN** is blinking.

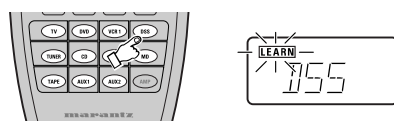

3. Press and hold down the **CL** button and press the learned button twice to be erased.
  - **CLR** is displayed for 3 seconds and the mode returns to **LEARN** mode.

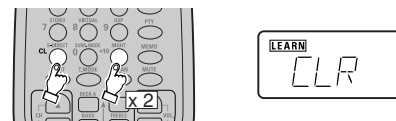

4. To return to the **USE** mode, press and hold down the **OK** button until **USE** is displayed in the display.

#### Erasing the code by functions

1. Press and hold down the **T.MODE** and **MEMO** buttons until **LEARN** is displayed in the display.

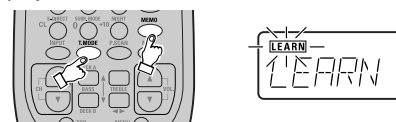

2. Press and hold down the **CL** button and press the learned **Function** button twice to be erased.
  - **F-CLR** and **LEARN** are blinking.

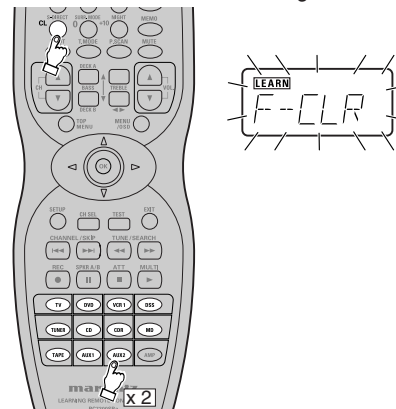

3. Press the **OK** button to continue erasing.
  - **F-CLR** is displayed for 3 seconds and the mode returns to **LEARN** mode.
  - To cancel the erasing operation, do not press the **OK** button and simply touch any other button.

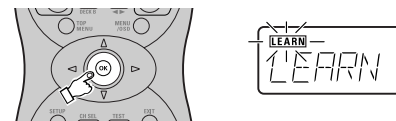

4. To return to the **USE** mode, press and hold down the **OK** button until **USE** is displayed in the display.

#### Erasing all functions

1. Press and hold down the **T.MODE** and **MEMO** buttons until **LEARN** is displayed in the display.



2. Press and hold down the **CL** button and press **POWER ON** and **POWER OFF** button.
  - **A-CLR** and **LEARN** are blinking.

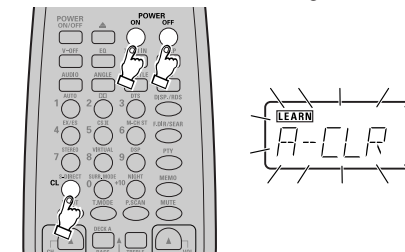

3. Press the **OK** button to continue erasing.
  - **A-CLR** is displayed for 3 seconds and the mode returns to **LEARN** mode.
  - To cancel the erasing operation, do not press the **OK** button and simply touch any other button.



4. To return to the **USE** mode, press and hold down the **OK** button until **USE** is displayed in the display.

#### Note:

- Erasing codes will return to the factory preset codes, or it will be empty if the button has no factory preset code.



## MACRO MODE

### PROGRAMMING MACROS

Macros make it possible to use a single function button to perform more complex series of operations that would normally require pressing several buttons. A single button can be programmed to perform up to 10 steps in a sequence. A typical example of such a series might be as follows:

- Turn the main amplifier power ON → Switch the function to DVD → Set the Surround Mode to Virtual → Set the DVD player to PLAY.
- No signals may be transmitted during macro programming.
- The various steps that make up a macro are sent initially to be sent one after another in 1 second intervals, however these intervals may be shortened to as little as 0.5 seconds or lengthened to as much as 5 seconds using the Setup mode.
- In the macro mode, the number of steps in the macro are displayed as well as the selected function's name.
- Macros may be programmed for each of the 12 function buttons as follows:  
TV, DVD, VCR1, DSS, TUNER, CD, CDR, MD, TAPE, AUX1, AUX2, AMP

1. Press and hold the **T.MODE** and **MENU** button until the **MACRO** is displayed.
  - **MACRO** and **LEARN** indicators are displayed blinking on the LCD, also.

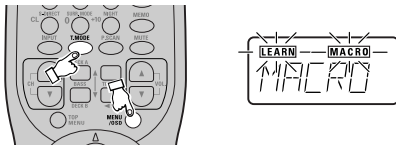

2. Press the **Function** button for which you wish to program a series of operations. In this case, let's use the example of the DVD player. Press the **DVD Function** button. The LCD will display DVD-M.



Characters displayed on the LCD include the following, depending on the function button for which the macro is being programmed:

TV-M, DVD-M, VCR-M, DSS-M, TUN-M, CD-M, CDR-M, MD-M, TAP-M, AX1-M, AX2-M, AMP-M

- If a macro has already been set for the selected function button, the LCD will blink.

3. Press the buttons for the operations you wish to program as a macro in the sequence you want the macro to program them.

For example, press DVD, PLAY.

- The number of steps in the macro is displayed on LCD and this number increases by 1 with each button pressed.
- Each function button can be programmed to perform up to 10 steps in sequence.



4. When you are finished programming macros, press and hold the **OK** button until the display returns to USE mode.

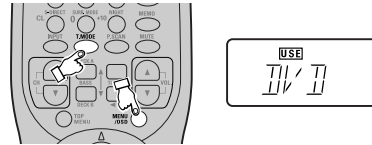

- Macros cannot be programmed for the **MEMO**, **cursor/OK**, **VOL ▲/▼** or **CL** buttons.

In the macro mode it is possible to program the memory to perform macros containing up to 10 steps.

- Each of the function operations (12 including CD, CD-R, etc.) can be used in a macro more than once, however for all except AMP, only the first function operation will be transmitted as a signal from the remote controller. Accordingly, within a single macro, it is not possible to switch between multiple function operations. (This is to prevent the switching of the receiver function operation.) Within a macro, the second time a function operation is used, it will only be used on the remote controller itself and no signal will be transmitted to the component.

### Note:

- If, while programming, no buttons are pressed for approximately 1 minute, the remote controll will automatically return to normal mode, and no macro will be programmed in the memory.

### CONFIRMING MACROS

Macros may be confirmed using the following procedure.

1. Press and hold the **T.MODE** and **MENU** button until the **MACRO** is displayed on the LCD.
  - **LEARN** and **MACRO** are displayed blinking.

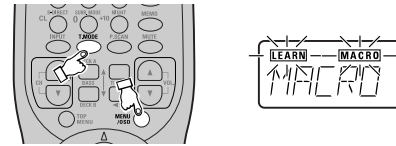

2. Press the **Function** button to be confirmed. Let's use the example of the DVD player, by pressing the **DVD Function** button.

- **DVD-M**, **LEARN** and **MACRO** are displayed blinking.

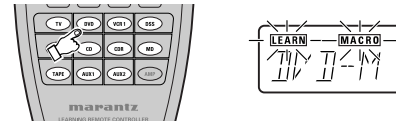

3. Press the **VOL ▲** button.

- **DVD-1** is displayed and **LEARN** is disappears.
- The programmed operation is transmitting.

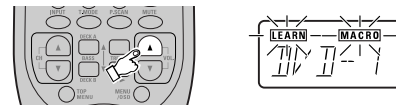

4. Repeat step 3. until the last number of the macro is displayed.

- The display will return to step 1.
- Each programmed operation is transmitting when the number of the macro is displayed.

5. To return to the USE mode, press and hold down the **OK** button until **USE** is displayed in the display.

### EDITING MACROS

Macros may be edited using the following procedure.

1. Press and hold the **T.MODE** and **MENU** button until the **MACRO** are displayed on the LCD.
  - **LEARN** and **MACRO** is displayed blinking.

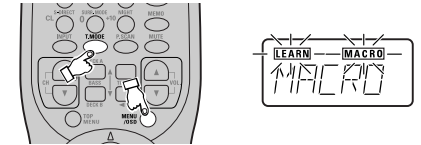

2. Press the **Function** button to be changed. Let's use the example of the DVD player, by pressing the **DVD Function** button.

- **DVD-M**, **LEARN** and **MACRO** are displayed blinking.

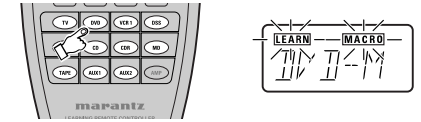

3. Press the **Cursor ▲/▼** buttons to select the number of the macro to be edited.

- The programmed operation is displayed after the number of the macro is displayed.
- The number of the macro can be changed with the cursor **▲/▼** buttons.

- To rewrite an existing macro step, simply press the button for the new step. The old step will be erased and rewritten with the new step.

- To insert a new step in between existing steps in a macro, after step 3 press the **MEMO** button, then press the button for the new step. The numbers of the other steps will be adjusted accordingly to accommodate the new step. Since only 10 steps may be stored in any macro, the tenth step will be erased if an step is inserted when the total number of steps is already 10.

- To erase a step in a macro, after step 3 call up the number of the step to be erased and press the **CL** button.

4. Press the **OK** button to return step 1.
5. To return the USE mode, press and hold down the **OK** button until **USE** is displayed in the display.

### USING MACROS

The following procedure will show how to use the function buttons for which you have programmed macros.

1. Press the **Function** button for the desired macro for 3 seconds.
  - **MACRO** is displayed on the LCD for approximately 1 second, after which the number of steps in the macro is displayed on the LCD.

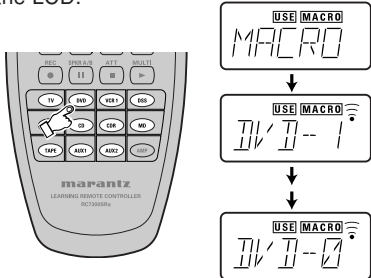

- The remote control will do nothing if no macros are programmed. The macro steps are executed in order and the names of their buttons are displayed on the LCD. Also, the step numbers displayed on the LCD disappear as each step is executed.

2. After all macro commands have been transmitted, the remote control returns to AMP in use mode.

### EXAMPLES OF MACRO PROGRAMS

#### Example 1

Change the input source for the amplifier to CD and play the 3rd track on a CD in the CD player.

1. Press and hold the **T.MODE** and **MENU** button until the **MACRO** is displayed on the LCD.
  - **LEARN** and **MACRO** is displayed blinking.

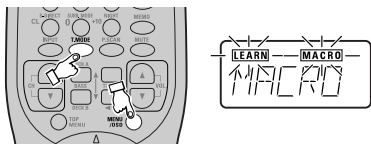

2. Press the **CD Function** button. CD-M is displayed on the LCD.

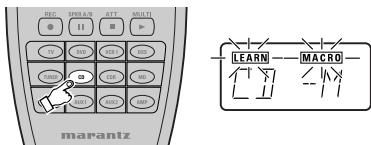

3. Press **CD**, **3**, and **▶** buttons.

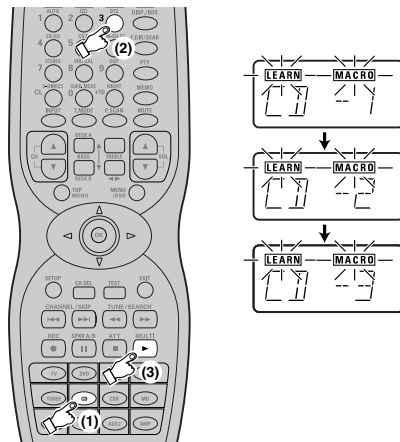

4. When you are finished programming the macro, press the **OK** button until the display returns to USE mode.



#### Now, execute the macro you just programmed.

1. Press the **CD Function** button for 3 seconds.

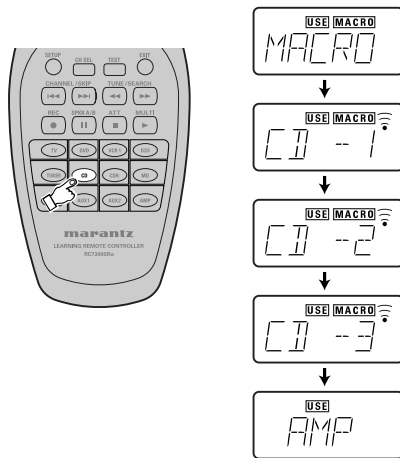

- The macro commands are transmitted to the components in order, and the steps of the operations are displayed on the LCD in order.

#### Example 2

Turn the main amplifier ON → Change the amplifier's input source to DVD → Set the Surround mode to VIRTUAL → Set the DVD player to PLAY.

1. Press and hold the **T.MODE** and **MENU** button until the **MACRO** is displayed on the LCD.
  - **LEARN** and **MACRO** are displayed blinking.

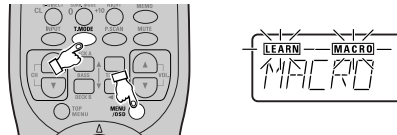

2. Press the **DVD Function** button.
  - Here the **DVD Function** button is used as the macro button, but any function button can in fact be used.

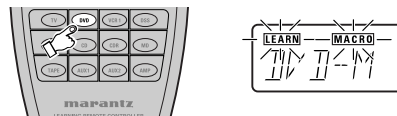

3. To set the various steps of the macro, press the following buttons in order:

(1) AMP\* → (2) POWER ON → (3) DVD → (4) AMP\* → (5) 8 (VIRTUAL) → (6) DVD\* → (7) ▶.

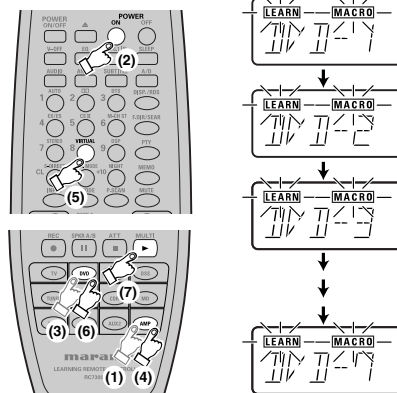

4. When you are finished programming the macro, press the **OK** button until the display returns to USE mode.



Now, execute the macro you just programmed.

1. Press the **DVD Function** button for 3 seconds. The macro commands are transmitted in order, and the steps of the operations are displayed on LCD in order.

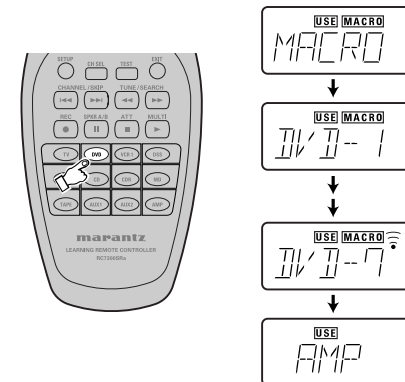

- When executing this macro, function operations AMP\* and DVD\* only switch the command set of the remote controller and no signal is transmitted to the component.

### CLEARING MACRO PROGRAMS

The following procedure is used to erase macros you have programmed into the remote controller's memory.

1. Press and hold the **T.MODE** and **MENU** button until the **MACRO** is displayed on the LCD.

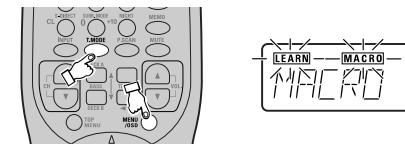

2. Press and hold the **CL** button, then press the button for the **Function** to be cleared (in this case DVD) for 3 seconds. **DVDCL** will appear on the LCD.

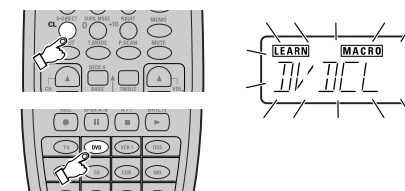

3. Press the **OK** button to clear and return step 1.
- To cancel the memory clearing operation, do not press the **OK** button and simply touch any other button.



4. To return to the USE mode, press and hold the **OK** button until **USE** is displayed in the display.

**ADJUSTING THE INTERVAL TIME OF MACRO**

**OPERATIONS TRANSMITTING**

1. Press and hold the **T.MODE** and **SETUP** button until the **SETUP** is displayed on the LCD.
- SETUP** is displayed for 3 seconds

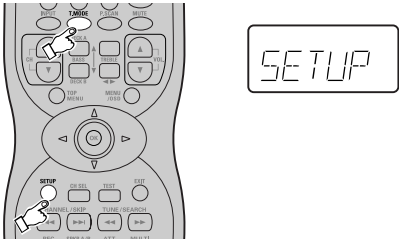

2. Confirm the display changes from **SETUP** to **MCRxx**. ("xx" means the interval time of macro operations transmitting )

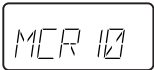

3. Press the Cursor **◀/▶** buttons to change the interval time.
- The interval time can be changed from 0.5 to 5 seconds by 0.5 seconds steps.

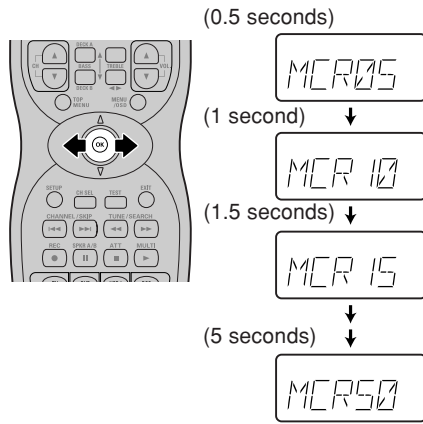

4. Press and hold down the **OK** button until **USE** is displayed in the display.

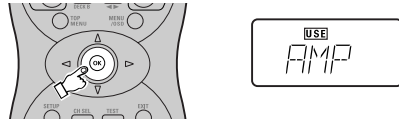

**TROUBLESHOOTING**

**In case of trouble, check the following before calling for service:**

- Are the connections made properly ?
- Are you operating the unit properly following the user's guide ?
- Are the power amplifiers and speaker working properly ?

If the unit does not operate properly, check items shown in the following table. If your trouble cannot be recovered with the remedy actions listed in the following table, malfunction of the internal circuitry is suspected; immediately unplug the power cable and contact your dealer, nearest Marantz authorized dealer or the Marantz Service Center in your country.

SYMPTOM	CAUSE	REMEDY
SR6400 cannot be turned up.	The power plug is not connected.	Connect the power plug to the outlet.
No sound and picture are output even when power is on.	Mute is on.	Cancel mute using the remote control unit.
	The input cable is not connected correctly.	See the connection diagram and connect the cables correctly.
	The master volume control is turned all the way down.	Adjust the master volume.
	The function selector position is wrong.	Select correct position.
No speaker output.	The headphones are connected to the headphone jack.	Disconnect the headphones. (Speakers will not output sound when headphones are connected.)
Incorrect Audio or Video for selected source.	Input cable connected incorrectly.	Connect the cable correctly by referring to the connection diagram.
Incorrect Audio from a channel.	Speaker cable connected incorrectly.	Connect the cable correctly by referring to the connection diagram.
No Audio output from the center channel speaker.	The center speaker cable connection is incomplete.	Connect the cable correctly.
	STEREO has been selected for Surround mode.	When STEREO is selected for Surround mode, no sound will be output from the center speaker. Set another Surround mode.
	Center = NONE has been selected in SETUP mode.	Make the correct setting.
No Audio output from the surround speakers.	The surround speaker cable connection is incomplete.	Connect the cable correctly.
	STEREO has been selected for Surround mode.	When STEREO has been selected for Surround mode, no sound will be output from the surround speaker. Set another Surround mode.
	Surround = NONE has been selected in SETUP mode.	Make the correct setting.
No Audio output from the surround back speakers.	The surround back speaker cable connection is incomplete.	Connect the cable correctly.
	Surround mode is not EX/ES mode.	Set surround mode EX/ES.
	Surround back = NONE has been selected in SPEAKERS SIZE SETUP	Make the correct setting.

SYMPTOM	CAUSE	REMEDY
Can not select EX/ES mode.	Surround center= NONE has been selected in SPEAKERS SIZE SETUP	Make the correct setting.
	Input signal is incompatible.	Use 5.1 channel source.
Can not select Pro Logic II mode.	Input signal is incompatible.	Use 2 channel Dolby Digital input signal, PCM input signal or analog input signal.
Can not select Neo:6 mode.	Input signal is incompatible.	Use 2 channel Dolby Digital input signal, PCM input signal or analog input signal.
Can not select CSII mode.	Input signal is incompatible.	Use 2 channel Dolby Digital input signal, PCM input signal or analog input signal.
No output to Sub Woofer Out.	Sub-woofer = NONE has been selected in SETUP mode.	Select Sub-woofer = YES.
Noise is produced during DTS-encoded CD or laser disc play.	Analog has been selected for input.	Be sure to perform digital connection, select digital input, then play.
A specific channel does not produce output.	Nothing recorded on source.	Check the encoded channel on the source side.
FM or AM reception fails.	Antenna connection is incomplete.	Correctly connect the indoor FM and AM antennas to FM and AM antenna outlets.
Noise is heard during AM reception.	Reception is affected by other electrical fields.	Try changing location where the AM indoor antenna is set up.
Noise is heard during FM reception.	The radio waves from the broadcasting station are weak.	Install an FM outdoor antenna.
Cannot get programmed station when the PRESET button is pressed.	Preset data has been erased.	Disconnecting power plug for long periods of time will erase preset data. If that happens, input the preset data again.
Control with the remote control unit fails.	Batteries are consumed.	Replace all the batteries with new ones.
	Remote controller's function-key setting is wrong.	Select different position from which equipment will be controlled.
	The distance between this SR6400 and the remote commander is too far.	Move closer to this SR6400.
	Something is blocking SR6400 and the remote commander.	Remove offending object.

**GENERAL MALFUNCTION**

If the equipment malfunctions, this may be because an electrostatic discharge or AC line interference has corrupted the information in the equipment memory circuits. Therefore:

- disconnect the plug from the AC line supply
- after waiting at least three minutes, reconnect the plug to the AC line supply
- re-attempt to operate the equipment

**Memory backup**

- In case a power outage occurs or the power cord is accidentally unplugged, the SR6400 is equipped with a backup function to prevent memory data such as the preset memory from being erased.

**HOW TO RESET THE UNIT**

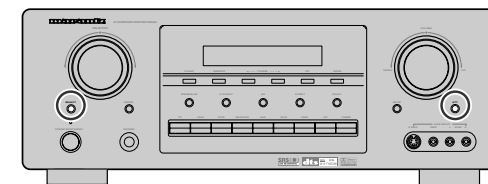

Should the operation or display seem to be abnormal, reset the unit with the following procedure.

The SR6400 is turned on, press and hold the **SELECT** and **ATT** buttons simultaneously for 3 seconds or more.

Remember that the procedure will reset the settings of the function selector, Surround mode, delay time, TUNER PRESET etc., to their initial settings.

# TECHNICAL SPECIFICATIONS

## FM TUNER SECTION

Frequency Range ..... 87.5 - 108.0 MHz  
 Usable Sensitivity ..... IHF 1.8  $\mu$ V/16.4 dB  
 Signal to Noise Ratio ..... Mono/Stereo 75/70 dB  
 Distortion ..... Mono/Stereo 0.2/0.3 %  
 Stereo Separation ..... 1 kHz 45 dB  
 Alternate Channel Selectivity .....  $\pm$  300 kHz 60 dB  
 Image Rejection ..... 98 MHz 70 dB  
 Tuner Output Level ..... 1 kHz,  $\pm$  75 kHz Dev 800 mV

## AM TUNER SECTION

Frequency Range ..... 520 - 1710 kHz  
 Signal to Noise Ratio ..... 50 dB  
 Usable Sensitivity ..... Loop 400 $\mu$ V  
 Distortion ..... 400Hz, 30 % Mod. 0.5 %  
 Selectivity .....  $\pm$  20 kHz 70 dB

## AUDIO SECTION

Power Output (20 Hz - 20 kHz/THD=0.08%)  
 Front L&R ..... 8 ohms 100 W / Ch  
 Center ..... 8 ohms 100 W / Ch  
 Surround L&R ..... 8 ohms 100 W / Ch  
 Surround Back ..... 8 ohms 100 W / Ch

Front L&R ..... 6 ohms 125 W / Ch  
 Center ..... 6 ohms 125 W / Ch  
 Surround L&R ..... 6 ohms 125 W / Ch  
 Surround Back ..... 6 ohms 125 W / Ch

Input Sensitivity/Impedance ..... 168 mV/ 47 Kohms  
 Signal to Noise Ratio(Analog Input / Source Direct) ... 105 dB  
 Frequency Response  
 (Analog Input / Source Direct)  
 ..... 8 Hz - 100 kHz ( $\pm$  3 dB)  
 (Digital Input / 96 kHz PCM)  
 ..... 8 Hz - 45 kHz ( $\pm$  3 dB)

## VIDEO

Television Format ..... NTSC  
 Input Level/Impedance ..... 1 Vp-p/75 ohms  
 Output Level/Impedance ..... 1 Vp-p/75 ohms  
 Video Frequency Response ..... 5 Hz to 8 MHz (-1 dB)  
 Video Frequency (Component) ... 5 Hz to 80 MHz (-1 dB)  
 S/N ..... 60 dB

## GENERAL

Power Requirement ..... AC 120 V 60 Hz  
 Power Consumption ..... 420 W  
 Weight ..... 27.6 lbs (12.5 Kg)

## ACCESSORIES

Remote Control Unit RC7300SRa ..... 1  
 AA-size batteries ..... 2  
 FM Feeder Antenna ..... 1  
 FM Antenna Converter ..... 1  
 AM Loop Antenna ..... 1

Specifications subject to change without prior notice.

# DIMENSIONS

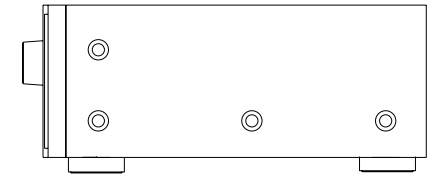
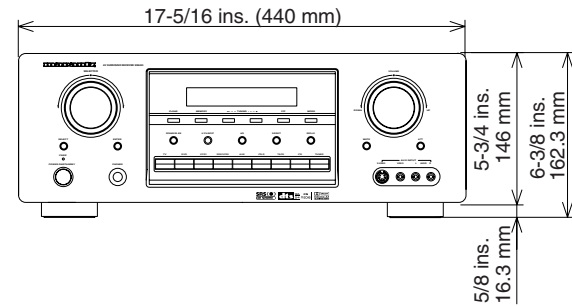
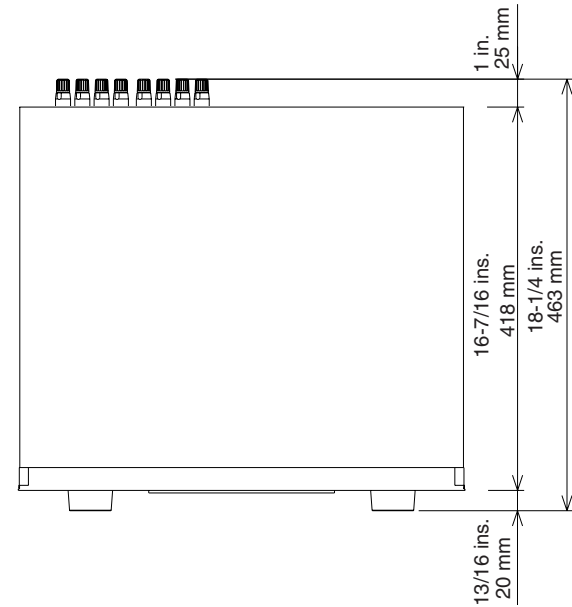

**www.marantz.com**

You can find your nearest authorized distributor or dealer on our website.

---

<b>JAPAN</b>	Marantz Japan, Inc.	35-1 Sagami Ohno 7-Chome, Sagamihara-shi, Kanagawa 228-8505, Japan
<b>U.S.A.</b>	Marantz America, Inc.	1100 Maplewood Drive, Itasca, IL 60143, U.S.A.
<b>EUROPE</b>	Marantz Europe B.V.	P.O. Box 8744, 5605 LS Eindhoven, The Netherlands

---

Manufactured under license from Dolby Laboratories. "Dolby", "Pro Logic" and the double-D symbol are trademarks of Dolby Laboratories. Confidential Unpublished Works. © 1992-1997 Dolby Laboratories, Inc. All rights reserved.

Manufactured under license from Digital Theater Systems, Inc. US Pat. No. 5,451,942 and other worldwide patents issued and pending. "DTS" and "DTS Digital Surround" are trademarks of Digital Theater Systems, Inc. © 1996 Digital Theater Systems, Inc. All rights reserved.

**marantz**<sup>®</sup> is a registered trademark.

