

marantz®

Model VP-12S3/VP-12S3L User Guide

DLP™ Projector

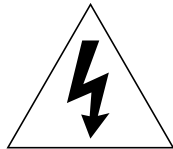

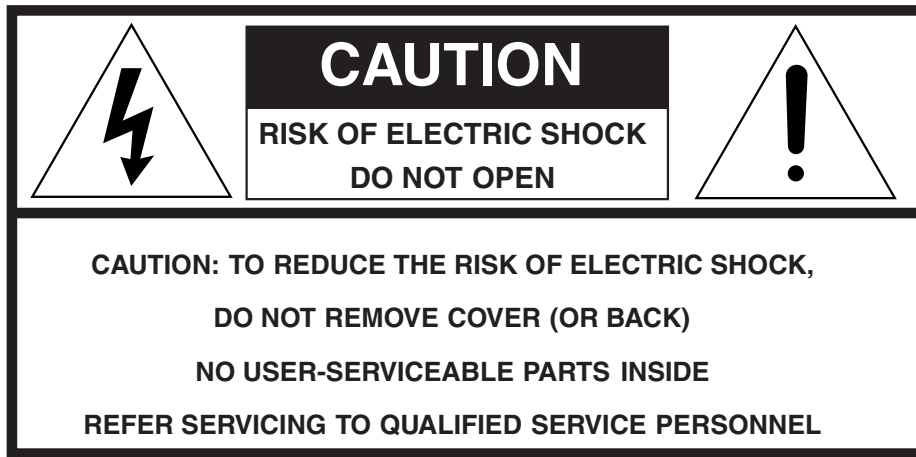

The lightning flash with arrowhead symbol within an equilateral triangle is intended to alert the user to the presence of uninsulated “dangerous voltage” within the product’s enclosure that may be of sufficient magnitude to constitute a risk of electric shock to persons.



The exclamation point within an equilateral triangle is intended to alert the user to the presence of important operating and maintenance (servicing) instructions in the literature accompanying the product.

WARNING

TO REDUCE THE RISK OF FIRE OR ELECTRIC SHOCK,
DO NOT EXPOSE THIS PRODUCT TO RAIN OR MOISTURE.

CAUTION: TO PREVENT ELECTRIC SHOCK, MATCH WIDE BLADE OF PLUG TO WIDE SLOT, FULLY INSERT.

ATTENTION: POUR ÉVITER LES CHOCS ÉLECTRIQUES, INTRODUIRE LA LAME LA PLUS LARGE DE LA FICHE DANS LA BORNE CORRESPONDANTE DE LA PRISE ET POUSSER JUSQU’AU FOND.

For the customers in the USA:

This equipment has been tested and found to comply with the limits for a Class B digital device, pursuant to Part 15 of the FCC Rules. These limits are designed to provide reasonable protection against harmful interference in a residential installation. This equipment generates, uses and can radiate radio frequency energy and, if not installed and used in accordance with the instructions, may cause harmful interference to radio communications. However, there is no guarantee that interference will not occur in a particular installation. If this equipment does cause harmful interference to radio or television reception, which can be determined by tuning the equipment off and on, the user is encouraged to try to correct the interference by one or more of the following measures:

- Reorient or relocate the receiving antenna.
- Increase the separation between the equipment and receiver.
- Connect the equipment into an outlet on a circuit different from that to which the receiver is connected.
- Consult the dealer or an experienced radio/TV technician for help.

NOTE:

Changes or modifications not expressly approved by the party responsible for compliance could void the user’s authority to operate the equipment.

For the customers in Canada:

This Class B digital apparatus meets all requirements of the Canadian Interference-Causing Equipment regulations.

IMPORTANT SAFETY INSTRUCTIONS

READ BEFORE OPERATING EQUIPMENT

This product was designed and manufactured to meet strict quality and safety standards. There are, however, some installation and operation precautions which you should be particularly aware of.

1. Read these instructions - All the safety and operating instructions should be read before the product is operated.
2. Keep these instructions - The safety and operating instructions should be kept for future reference.
3. Heed all warnings - All warnings on the product and in the operating instructions should be adhered to.
4. Follow all instructions - All operating and use instructions should be followed.
5. Do not use this apparatus near water - Do not use this product near water-for example, near a bath tub, wash bowl, kitchen sink, or laundry tub, in a wet basement, or near a swimming pool, and the like.
6. Clean only with dry cloth - Unplug this product from the wall outlet before cleaning. Do not use liquid cleaners or aerosol cleaners. Use a dry cloth for cleaning.
7. Do not block any ventilation openings. Install in accordance with the manufacture's instructions.
8. Do not install near any heat sources such as radiators, heat registers, stoves, or other apparatus (including amplifiers) that produce heat.
9. Do not defeat the safety purpose of the polarized or grounding-type plug. A polarized plug has two blades with one wider than the other. A grounding type plug has two blades and a third grounding prong. The wide blade or the third prong are provided for your safety. If the provided plug does not fit into your outlet, consult an electrician for replacement of the obsolete outlet.

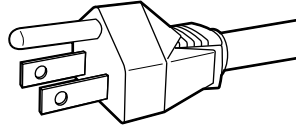

AC GROUNDING-TYPE PLUG

10. Protect the power cord from being walked on or pinched particularly at plugs, convenience receptacles, and the point where they exit from the apparatus.
11. Only use attachments/accessories specified by the manufacturer.
12. Use only with the cart, stand, tripod, bracket, or table specified by the manufacturer, or sold with the apparatus. When a cart is used, use caution when moving the cart/apparatus combination to avoid injury from tip-over.



13. Unplug this apparatus during lightning storms or when unused for long periods of time.
14. Refer all servicing to qualified service personnel. Servicing is required when the apparatus has been damaged in any way, such as power-supply cord or plug is damaged, liquid has been spilled or objects have fallen into the apparatus, the apparatus has been exposed to rain or moisture, does not operate normally, or has been dropped.
15. This product should not be placed in a built-in installation such as a bookcase or rack unless proper ventilation is provided or the manufacturer's instructions have been adhered to.
16. To prevent fire or shock hazard, do not place objects filled with liquids, such as vases, on the apparatus.

This Class B digital apparatus complies with Canadian ICES-003.

Cet appareil numérique de la Classe B est conforme à la norme NMB-003 du Canada.

Lamp Handling Precautions

DANGER

This SHP uses a high voltage glass mercury vapor lamp. The lamp can break or fail to light if handled wrongly during replacement or because of the projector's surrounding temperature.

Lamp life also varies according to the lamp with some even breaking or failing to light as soon as they are used the first time. If the lamp breaks, glass fragments may be scattered inside the lamp unit and projector, and gas inside the lamp bulb that contains mercury vapor may be emitted from the projector's vent.

Before use, carefully read the projector user guide and the lamp replacement instructions. Remember to handle the lamp with care. In the event of serious trouble, call for Marantz authorized dealer.

- Do not look directly into the lamp with bare eyes while lit. The bright light can cause sore eyes and impair vision.
- Do not directly expose skin to the light of the lamp. Direct exposure can inflame the skin.
- Do not drop, impact, subject to excessive force or otherwise damage the lamp.
- Replacing the lamp runs the risk of burns and electric shock, therefore shut OFF power supply, unplug the AC power cord from AC power outlet and wait at least 60 minutes for the lamp to cool down before attempting to replace it.
- If the lamp breaks, unplug the AC power cord from AC power outlet and call for Marantz authorized dealer to replace it. Do not replace the lamp yourself or clean up broken glass inside the projector as this can result in cuts and burns to you or damages inside the projector.
- If the projector is hung from a ceiling or installed in a high place, it is extremely dangerous to replace the lamp. In this case, do not replace or handle the damaged lamp yourself.

CAUTION

- The chance of the lamp breaking is high after extended use. It is recommended to replace the lamp when near the end of its designed life. Do not use a lamp beyond the maximum lighting time.
- Use only Marantz original lamp units. Check the model code of the lamp unit matches that in the user guide.
- Before replacing the lamp, read carefully "Lamp Unit Replacement" in the user guide. Replace the lamp as explained therein.
- Entrust disposal of a used lamp to a licensed industrial waste handler or return it to the place of purchase. Do not break the lamp or discard with general waste.
- If the lamp breaks, leave the area immediately and stay away for at least 30 minutes, and ventilate the room so as not to inhale the mercury vapor.
- If you inhale the mercury vapor, see a physician immediately and follow his instructions.

Précautions à prendre pour la manipulation de la lampe

DANGER

Ce SHP utilise une lampe à vapeur de mercure en verre à haute tension. Cette lampe peut se casser ou ne pas s'allumer si elle est manipulée incorrectement pendant son remplacement ou du fait de la température ambiante du projecteur.

La durée de service d'une lampe varie aussi en fonction de la lampe, certaines se cassant ou ne s'allumant pas aussitôt qu'elles sont utilisées pour la première fois. Si la lampe se casse, des fragments de verre peuvent se répandre à l'intérieur de l'unité lampe et du projecteur, et le gaz à l'intérieur de l'ampoule de la lampe qui contient de la vapeur de mercure peut être émis par l'orifice du projecteur.

Avant utilisation, lisez attentivement le guide de l'utilisateur du projecteur et les instructions de remplacement de la lampe. Pensez à manipuler la lampe avec précautions. En cas de problème sérieux, contactez un distributeur agréé Marantz.

- Ne regardez pas directement la lampe sans protection pour les yeux pendant qu'elle est allumée. Sa lumière brillante peut faire mal aux yeux et affaiblir la vue.
- N'exposez pas directement la peau à la lumière de la lampe. Une exposition directe peut provoquer une inflammation de la peau.
- Ne laissez pas tomber la lampe, ne la heurtez pas, ne la soumettez pas à une force excessive ni ne l'endommager.
- Le remplacement de la lampe fait courir un risque de brûlure et de choc électrique ; il faut donc couper l'alimentation électrique, débrancher le cordon d'alimentation secteur de la prise secteur et attendre au moins 60 minutes que la lampe refroidisse avant d'essayer de la remplacer.
- Si la lampe se casse, débranchez le cordon d'alimentation secteur de la prise secteur et contactez un distributeur agréé Marantz pour qu'il la remplace. Ne remplacez pas la lampe vous-même ni ne nettoyez le verre brisé à l'intérieur du projecteur car vous pourriez vous couper et vous brûler ou endommager l'intérieur du projecteur.
- Si le projecteur est accroché au plafond ou installé dans un endroit en hauteur, il est extrêmement dangereux de remplacer la lampe. Dans ce cas, ne remplacez ni ne manipulez vous-même la lampe endommagée.

ATTENTION

- Le risque que la lampe se casse est élevé après une utilisation prolongée. Il est recommandé de remplacer la lampe lorsqu'elle approche de sa durée de service spécifiée. N'utilisez pas une lampe au-delà du temps d'éclairage maximum.
- N'utilisez que des unités lampes d'origine Marantz. Vérifiez que le code de modèle de l'unité lampe correspond à celui indiqué dans le guide de l'utilisateur.
- Avant de remplacer la lampe, lisez attentivement "Remplacement de l'unité lampe" dans le guide de l'utilisateur. Remplacez la lampe conformément aux explications de cette section.
- Confiez la mise au rebut d'une lampe usée à un service de déchets industriels licencié ou retournez-la où vous l'avez achetée. Ne cassez pas la lampe ni ne la jetez avec les ordures ménagères.
- Si la lampe se casse, sortez immédiatement de la zone pendant au moins 30 minutes, et aérez la pièce afin de ne pas inhaler la vapeur de mercure.
- Si vous inhalez de la vapeur de mercure, consultez immédiatement un médecin et suivez ses instructions.

Precauciones para la manipulación de la lámpara

PELIGRO

Esta lámpara SHP de vidrio y de alto voltaje contiene vapor de mercurio. La lámpara puede romperse o no encenderse si es manipulada incorrectamente durante el recambio o debido a la temperatura ambiente del proyector.

La vida útil también varía según las lámparas, algunas de las cuales se rompen o no se encienden al cabo del primer uso. Si la lámpara se rompe, los fragmentos de cristal se pueden desparramar por el interior de la unidad de la lámpara y del proyector, y el gas con vapor de mercurio contenido en la bombilla se puede escapar a través del sistema de ventilación del proyector.

Antes de usar el aparato, lea con cuidado la guía de usuario del proyector y las instrucciones de recambio de la lámpara. No olvide manipular con cuidado la lámpara. En caso de producirse problemas serios, avise a un distribuidor autorizado de Marantz.

- No mire directamente a la lámpara sin protección en los ojos cuando ésta esté encendida. La luz brillante puede irritar los ojos e impedir la visión.
- No exponga directamente la piel a la luz de la lámpara. La exposición directa puede inflamar la piel.
- No deje caer la lámpara, ni la golpee, ni la someta a presiones excesivas, ya que de lo contrario la lámpara se daña.
- El recambio de la lámpara entraña el riesgo de quemaduras y descargas eléctricas, y por lo tanto, deberá apagar el aparato, desenchufar el cable de alimentación del tomacorriente de CA, y esperar al menos 60 minutos a que la lámpara se enfríe antes de intentar recambiarla.
- Si la lámpara se rompe, desenchufe el cable de alimentación de CA y avise a un distribuidor autorizado de Marantz para recambiarla. No recambie la lámpara usted mismo ni limpie los cristales rotos en el interior del proyector, pues podría sufrir cortes y quemaduras y ocasionar daños en el interior del proyector.
- Si el proyector cuelga del techo o está instalado en un lugar elevado, el recambio de la lámpara es extremadamente peligroso. En tal caso, no recambie ni manipule usted mismo la lámpara dañada.

PRECAUCIÓN

- La probabilidad de que la lámpara se rompa es alta después de un uso prolongado. Se recomienda recambiar la lámpara cerca de la fecha de expiración de su vida útil prevista. No utilice una lámpara más tiempo del máximo de iluminación previsto.
- Utilice sólo lámparas originales de Marantz. Compruebe que el código del modelo de la lámpara coincide con el de la guía de usuario.
- Antes de recambiar la lámpara, lea atentamente la sección "Recambio de la lámpara" en la guía de usuario. Recambie la lámpara tal y como viene allí explicado.
- Confíe el desecho de la lámpara usada a un manipulador autorizado de desechos industriales o devuélvala al lugar donde la compró. No rompa la lámpara ni la deseche en la basura normal.
- Si la lámpara se rompe, abandone la zona inmediatamente y permanezca alejado durante al menos 30 minutos, ventilando la habitación con objeto de no inhalar el vapor de mercurio.
- Si inhala vapor de mercurio, consulte inmediatamente a su médico y siga sus instrucciones.

Precauções para o manuseio da lâmpada

CUIDADO

Esta lâmpada SHP é uma lâmpada feita de vidro que contém vapor de mercúrio a alta pressão. A lâmpada pode quebrar ou não acender caso seja manuseada incorrectamente durante a substituição ou devido à temperatura ambiente onde se encontra o projector.

A vida útil da lâmpada também varia conforme a lâmpada, com casos de quebra ou falha em acender na primeira vez que a lâmpada é utilizada. Se a lâmpada quebrar, estilhaços de vidro podem cair dentro do compartimento da lâmpada e do projector, e o gás de dentro da lâmpada que contém vapor de mercúrio poderá ser emitido através da saída do projector.

Antes de o utilizar, leia cuidadosamente o guia do utilizador do projector bem como as instruções para substituição da lâmpada. Lembre-se de manusear a lâmpada com cuidado. No caso de problemas, entre em contacto com o representante autorizado da Marantz.

- Não olhar directamente na lâmpada acesa sem protecção ocular. A luz forte pode causar irritação nos olhos ou prejudicar a visão.
- Não expor a pele directamente à luz da lâmpada. Exposição directa pode causar inflamação na pele.
- Não derrubar, bater, nem usar força excessiva, pois pode danificar a lâmpada.
- Devido ao risco de queimaduras e choque eléctrico ao substituir a lâmpada, desligue a alimentação, desligue o cabo de alimentação da tomada de CA e espere pelo menos 60 minutos para arrefecer antes de substituir a lâmpada.
- Se a lâmpada quebrar, desligue o cabo de alimentação de CA da tomada e entre em contacto com o representante autorizado da Marantz para que faça a substituição. Não tente fazer a substituição nem limpar os estilhaços de vidro de dentro do projector, pois pode resultar em cortes e queimaduras ou ainda danos ao projector.
- Se o projector estiver instalado no teto ou qualquer lugar alto, é extremamente perigoso substituir a lâmpada. Nesse caso, não tente fazer a substituição nem manusear o lâmpada danificada.

AVISO

- A probabilidade da lâmpada quebrar aumenta depois de um longo período de utilização. É recomendável substituir a lâmpada quando a vida útil da mesma estiver próxima do fim. Não utilizar a lâmpada além do tempo máximo determinado.
- Utilizar apenas lâmpadas genuínas Marantz. Confirme que o código do modelo da lâmpada corresponde com o listado no guia do utilizador.
- Antes de substituir a lâmpada, leia cuidadosamente a secção "Substituição da lâmpada" no guia do utilizador. Substitua a lâmpada de acordo com as instruções dadas.
- Para jogar uma lâmpada usada, solicite os serviços de uma companhia autorizada a colectar lixo industrial ou devolva a lâmpada na loja onde a adquiriu. Não quebrar a lâmpada nem jogá-la com o lixo comum.
- Se a lâmpada quebrar, saia da sala imediatamente, ventile o ambiente para evitar inalar o vapor de mercúrio e não retorne por pelo menos 30 minutos.
- Se inalar o vapor de mercúrio, consulte um médico imediatamente e siga as suas instruções.

TABLE OF CONTENTS

IMPORTANT SAFEGUARDS	1
Caution:Concerning the Lamp Replacement	1
Caution:Concerning the Lamp Unit	1
Caution:Concerning the Setup of the Projector	1
Notes on Operation	1
FEATURES	2
ACCESSORIES	3
PROJECTOR LAYOUT AND FUNCTIONAL OVERVIEW	4
Front and Top View	4
Rear and Terminals View	5
Bottom View	5
Remote Controller	6
Remote Controller Operational Range	7
Preparing the Remote Controller.....	7
CONNECTION	8
Connection with AC Power Supply	8
Connection with Video Equipments.....	8
Connection with a HD-Video, Satellite, Cable Tuner or PC	9
Advanced Connection	9
INITIAL SETTING	10
Turning on the Power	10
Zooming and Focusing	10
Adjusting the Image Position	10
Adjusting the Height	11
Detail Focusing.....	11
Keystone Correction.....	12
INSTALLATION	13
Recommended Setting	13
Screen Size and Projection Distance (inch) VP-12S3.....	14
Screen Size and Projection Distance (m) VP-12S3	15
Screen Size and Projection Distance (inch) VP-12S3L.....	16
Screen Size and Projection Distance (m) VP-12S3L	17
BASIC OPERATIONS	18
Turning on the Power	18
Selecting the Input Signal Source	18
Selecting the Aspect Mode.....	18
The Screen Images in a 16:9 screen	19
The Screen Images in a 4:3 screen	20
To Turn off the Power.....	21
OPERATIONS	22
Menu Structure.....	22
How to Operate Menus	23
Picture Adjust	24
Fine Menu	25
Setting	27
System	28
Display.....	29
Configuration	30
Trigger 2	31
Preset	32
MAINTENANCE	33
Lamp Life and Replace Lamp	33
Replacing Lamp Unit	34
Color Temperature Adjustment	36
Cleaning the Lens	37
Replacement Parts.....	37
Optional Accessories.....	37
TROUBLESHOOTING	38
ERROR MODE	39
ON SCREEN MESSAGE	39
SPECIFICATIONS	40
DIMENSIONS	42
GLOSSARY	43

IMPORTANT SAFEGUARDS

Caution Concerning the Lamp Replacement

There is potential glass particle hazard if the lamp ruptures.

Caution Concerning the Lamp Unit

There is a potential hazard of glass particle if the lamp ruptures.
In case of lamp rupture, contact your nearest Marantz Authorized Dealer or Service Center for a replacement.
See "Replacing Lamp Unit". (P.34)

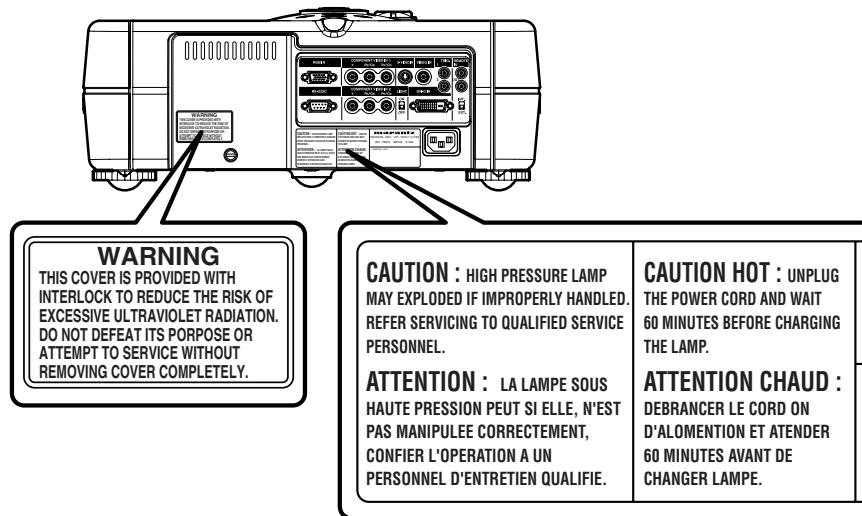

Caution Concerning the Setup of the Projector

For minimal servicing and to maintain high image quality, avoid humidity, dust and cigarette smoke.

When the projector is subjected to these environments, the lens and part of ventilation holes must be cleaned more often than usual. As long as the projector is properly maintained in this manner, use in these environments will not reduce the overall operation life. Please note that all internal cleaning must be performed by an Marantz Authorized Dealer, or Service Center.

- Do not expose the projector to extreme heat or cold.
Operating temperature: 41 °F to 95 °F (+5 °C to 35 °C)
Storage temperature: -4 °F to 140 °F (-20 °C to +60 °C)

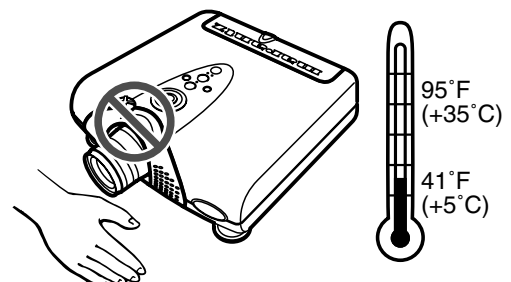

Notes on Operation

- The exhaust ventilative hole, the lamp cage cover and adjacent areas may get extremely hot during projector operation. To prevent injury, do not touch these areas until they have sufficiently cooled down.
- Allow at least 1 foot (30 cm) of space between the exhaust ventilative hole and the nearest wall or obstruction.
- If the cooling fan becomes obstructed, a protection device will automatically turn off the projector lamp. This does not indicate a malfunction. Remove the projector power cord from the wall outlet and wait at least 10 minutes. Then turn on the power by plugging the power cord back in. This will return the projector to the normal operating condition.

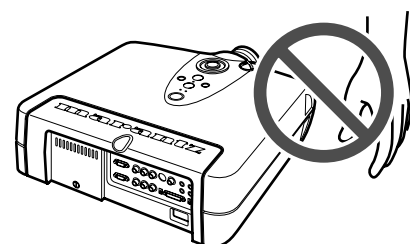

FEATURES

- High Picture Quality Technology -

❖ DLP™ technology to deliver the highest contrast ratio (3800:1) in the industry

- Incorporates the latest DMD™ element -- HD2+ (1280 x 720 pixel, 16:9 wide panel). Using an optimized system for movie viewing with specially designed image circuits and optical parts, the VP-12S3/VP-12S3L bring high color reproduction with the pitch black of movie films that reproduces images in rich tones and crisp black.

❖ Built-in image processing IC by Faroudja to project high quality video images

- Images are sharply detailed, smooth and high quality owing to a powerful 3-chip set that builds into a dedicated processor an image processing IC featuring Faroudja's proud "DCDi™" high quality contouring technology, "high performance adaptive IP conversion" and "2-3 pull-down capabilities".

❖ Optical unit that very accurately projects the entire image in high quality viewing format

- Incorporates a Minolta optical system custom-made for Marantz projectors featuring a 13-section 14-lens system that uses anomalous dispersion glass to minimize color aberration. Images come out sharply focused.
- O.R.C.A. (Optically Reproducing Color Accurately) filter that greatly improves color purity.
- New developed 7-segment color wheel that builds an ND filter into a large 98 mm 3-primary color wheel for theater projection.

- Wide Array of Features -

❖ Automatic color temperature adjustment

- Using the included color temperature sensor, the VP-12S3/VP-12S3L automatically adjust color temperature after lamp changes or as lighting changes over time.

❖ Image quality adjustment capabilities for making images as one prefers

- 4 images modes to select as demanded by the listening /viewing environment and image source (Theater, Standard, Dynamic, User)
- 5 new built-in preset gammas
- Fine-adjustment menus that allow the user to adjust images as they like
- 18 user menus for saving adjusted images
- Color temperature setting (5250K, 5800K, 6500K, 7500K, 9300K)
- Black level adjustment (0 IRE, 7.5 IRE, EXPAND, NORMAL [For DVI-D input])

- Create a Comfortable Home Theater Environment -

❖ Versatile input support including high-vision satellite broadcast

- Supports input of NTSC, PAL, SECAM and satellite broadcasts (480i, 480p, 720p, 1035i, 1080i).
- Rich array of input jacks including HDCP supporting DVI-D digital input jack and dual system component jacks

❖ Easy to install and operate

- 1.2x zoom lens
- Lens shift feature for vertically positioning the projection point
- Digital correction of horizontal-vertical keystone distortion
- Projection modes for functional, hanging and rear projection
- Height adjustment function
- Light-up luminous remote control
- Light-up I/O jacks for easy connections and setup in dark environments
- Equipped with RS-232C port and 12V trigger terminal for custom installation
- Marantz system bus port

❖ Designed for silence and safety

- Low operating noise thanks to a die-cast silent duct, hermetically sealed color wheel motor and fan speed control
- Highly rigid die-cast chassis to minimize radiating noise
- 2000 hr long-life 200W SHP lamp with double-shielded safety structure

– DLP, Digital Micromirror Device and DMD are trademarks of Texas Instruments.

– "DCDi" is a trademark of Faroudja. Faroudja is a wing of Genesis Microchip Inc.

– All trademarked product names mentioned in this manual are the property of their respective companies.

– The DVI logo is a trademark of the DDWG (Digital Display Working Group).

Note: Pixel defects

DMD™ (Digital Micromirror Device™) is one of the most advanced technologies for consumer products. The DMD™ made by high precision technology, however some pixel defects may be found on the projected image. We are trying our best to control the quality in order to reduce the number of defective pixels. It is almost impossible to have zero pixel defects, even using the most advanced technology. This is not a problem only for Marantz, but all DLP™ projector manufactures. Therefore we have to note that the warranty does not cover the DMD™ for pixel defects. We appreciate your understandings.

Note: Lamp

SHP lamp is one of the most advanced technologies for consumer products. The lamp made by high precision technology, however some lamps might be failing before it reaches its life. And projector's brightness is getting darker along with accumulated lamp usage hours. We are trying our best to control the quality in order to reduce lamp failures. It is almost impossible to have zero failure, even using the most advanced technology. This is not a problem only for Marantz, but all projector manufactures. Therefore we have to note that the warranty does not cover the SHP lamp for lamp failures: explosion, and non-lighting except initial use. And also we have to note that the warranty does not cover the SHP lamp for lamp failures: flickering, and getting darker along with accumulated lamp usage hours. We appreciate your understandings.

ACCESSORIES

- Lens Cap x 1

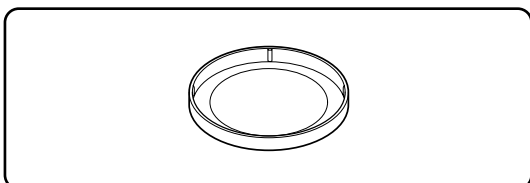

- Remote Controller x 1

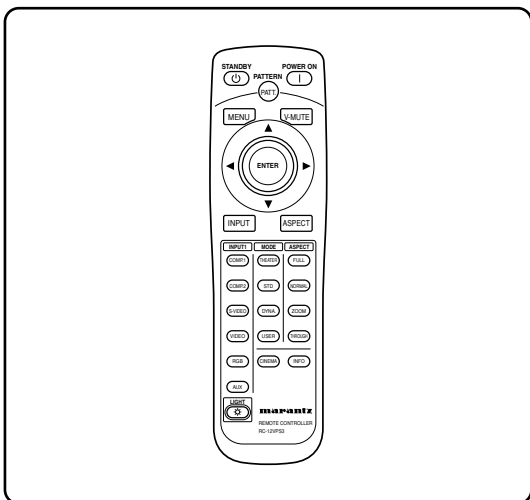

- AA Size Batteries x 2

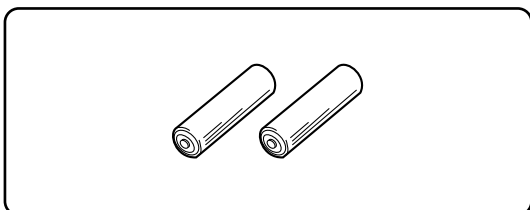

- Color temperature sensor x 1

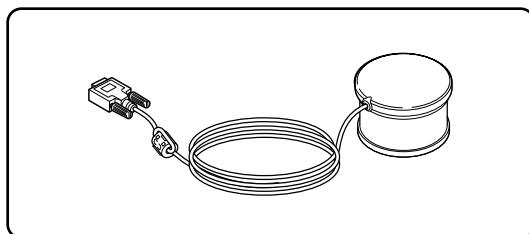

- AC Power Code (Only for 125V) x 1

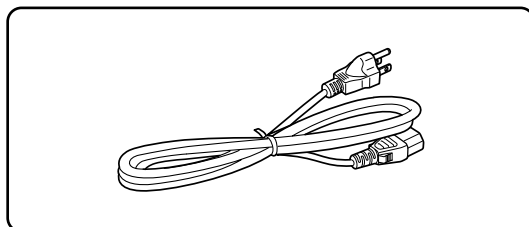

- Control Adapter Cable (Mini Jack to RCA) x 1

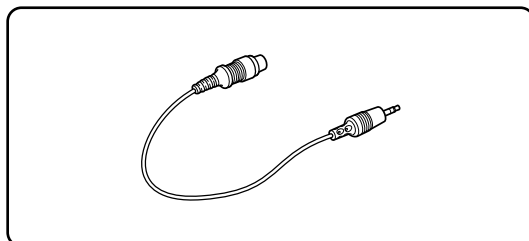

- User Guide x 1

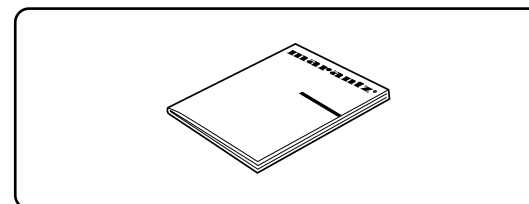

- Warranty Card (1 copy each for USA, CANADA)

PROJECTOR LAYOUT AND FUNCTIONAL OVERVIEW

Front and Top View

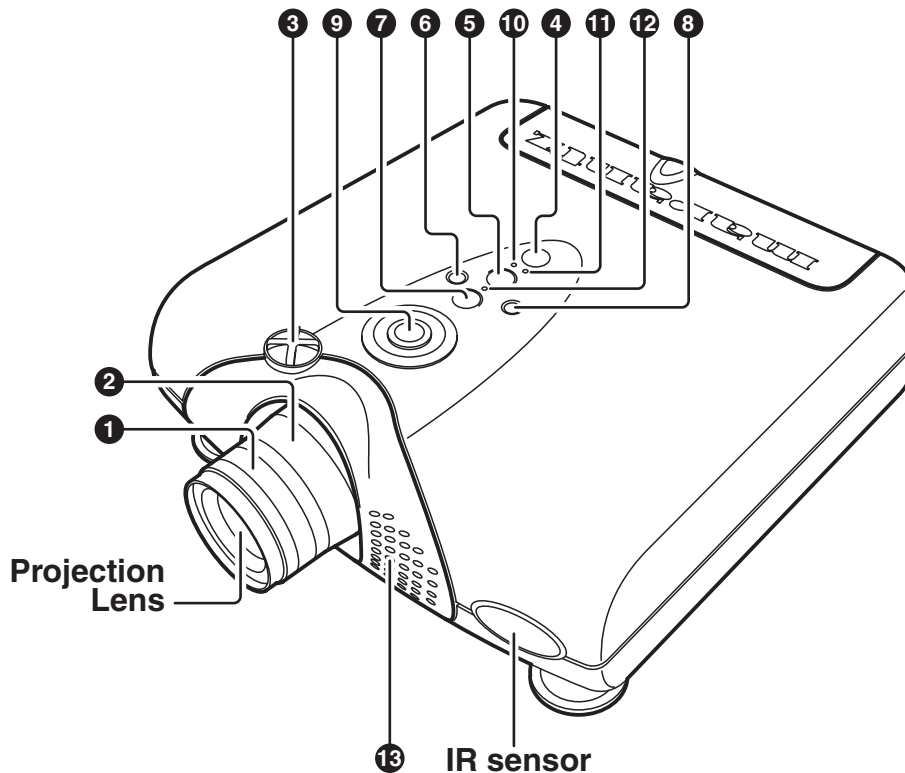

❶ Focus ring (➡ P.10)

Adjust the picture focus.

❷ Zoom ring (➡ P.10)

Adjust the size of the projected image.

❸ Lens Shift knob (➡ P.10)

Manually adjust the position of the image vertically.

❹ POWER button (➡ P.10)

Press to turn the projector ON or STANDBY mode.

❺ MENU button (➡ P.23)

Display the on-screen menu.

❻ ENTER button

Press to enter the selected menu item.

❼ INPUT SELECT button (➡ P.18)

Selects the input signal (COMPONENT 1, COMPONENT 2, S-VIDEO, VIDEO, RGB and AUX).

❽ PATTERN button (➡ P.11)

Projects a focus pattern on the screen.

❾ The ▲/▼/◀/▶ buttons

Control the MENU cursor.

❿ POWER ON indicator

Lights up blue when power is ON. When power is shut OFF, the lamp flashes for about 1 minute before going out.

⓫ STANDBY indicator

Lights up when the power is turned off.

⓬ WARNING/LAMP indicator

Flashes or lights up when something is wrong with the lamp cover, lamp, fan, or temperature inside the projector. For more information on the error mode, see the "Error Mode List" (➡ P.39)

⓭ Ventilation holes

Notes:

- Do not place anything near the ventilation holes to avoid overheat inside the unit.
- Do not place your hand or objects near the ventilation holes; the air is coming out.

Rear and Terminals View

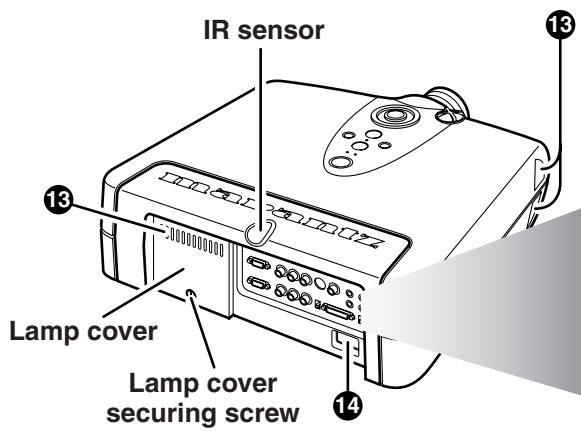

Terminals

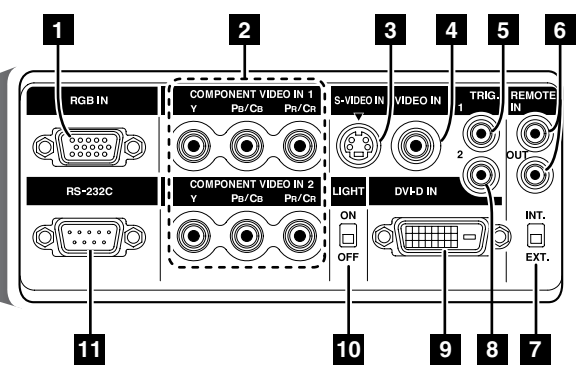

14 AC IN (P.8)
Connect the supplied AC power code.

❖ Terminals

1 RGB IN
Connect the analog RGB output from an IBM VGA or compatible equipment.

2 COMPONENT VIDEO IN 1 and 2
Terminals 1 and 2 have each Y, Pb/Cb, Pr/Cr terminals. Connect them to the component video output of a video device, AV amp/processor, DVD player, etc.

3 S-VIDEO IN
Connect the S-VIDEO output from a video equipment.

4 VIDEO IN
Connect the composite video output from a video equipment.

5 TRIG.1(TRIGGER 1)
When the unit is turned on, 12V is output. When the unit is turned off, no voltage is output. This allows such as a powered up/down screen, whenever the projector is turned on or off.

Note:
To connect with external devices, use an ordinal 3.5mm mini-plug (mono) cable.

6 REMOTE CONTROL IN/OUT
By connecting this projector to another Marantz audio component using a supplied System Control cable, you can remotely operate the components as a single system.

- When connecting to component with a remote sensor (such as the SR9200, SR8200), be sure to connect the "REMOTE CONTROL IN" jack of this projector to the "REMOTE CONTROL OUT" jack of the component with the remote sensor.

Note:
For connections, always use the included bus control adaptor cable.

7 REMOTE switch (EXT. / INT.)
When using this projector independently, set this switch to "INT.". When using this projector in a system with a Marantz DVD player or AV Receiver equipped with a remote sensor, set the switch to "EXT.".

8 TRIG.2(TRIGGER 2)
Select ON or OFF at each aspect mode, such as Full, Normal, Zoom, and Through to control screen aspect ratio with powered up/down dual aspect ratio screen.

Notes:

- Do not use TRIG.1 and TRIG.2, as the power source.
- To connect with external devices, use an ordinal 3.5mm mini-plug (mono) cable.

9 DVI-D IN
Connect the digital RGB signal (TMDS compliant, single link only)

Note: To use the DVI-D terminal, please follow the cautions on page 9.

10 LIGHT ON/OFF
Select ON : The terminal panel lights up.

11 RS-232C
This is the control port for the custom installer.

Bottom View

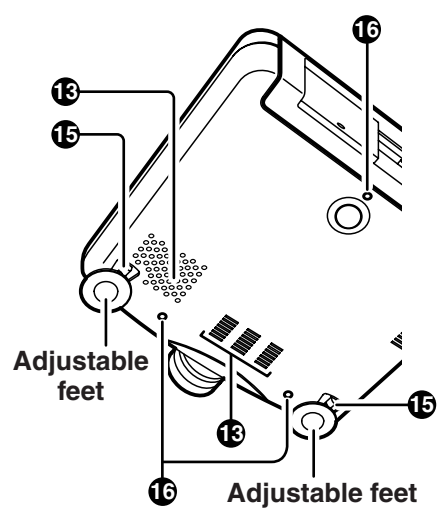

15 Adjustment lever (P.11)
Lift the projector and turn the adjustment lever right or left. The adjustable feet will extend from the projector. Then, release the lever, the adjustable feet is locked.

16 Screw holes for ceiling mount kit

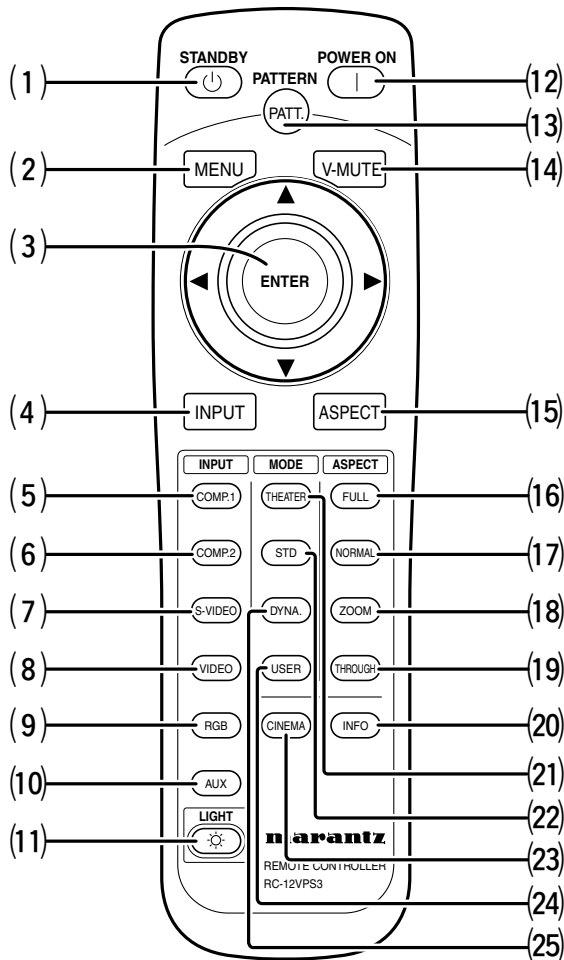

(1) STANDBY button (P.21)

Turn the projector off.

(2) MENU button (P.23)

Display the on-screen menu.

(3) ▲ / ▼ / ◀ / ▶ / ENTER buttons

Press the cursor buttons (▲ [UP], ▼ [DOWN], ◀ [LEFT], ▶ [RIGHT]) to select menu items. Press the button at its center to enter the selected item.

(4) INPUT (Input signal select) button (P.18)

Selects the input signal. Every time the button is pressed, the selection rotates in the order of COMPONENT 1 → COMPONENT 2 → S-VIDEO → VIDEO → RGB → AUX.

(5) COMP. 1 (Component video in 1) button (P.18)

Selects the device connected to the COMPONENT VIDEO IN 1 jack as the input source.

(6) COMP. 2 (Component video in 2) button (P.18)

Selects the device connected to the COMPONENT VIDEO IN 2 jack as the input source.

(7) S-VIDEO button (P.18)

Select the S-VIDEO IN signal.

(8) VIDEO button (P.18)

Select the VIDEO IN signal.

(9) RGB button (P.18)

Select the RGB IN signal.

(10) AUX button (P.18)

Select the DVI-D IN signal.

(11) LIGHT button

Lights up backlit buttons (POWER ON, STANDBY, MENU, V-MUTE, INPUT, ASPECT, PATTERN) for about 7 sec.

(12) POWER ON button (P.10)

Turn the projector on.

(13) PATT. (Pattern) button (P.11)

Projects a focus pattern on the screen.

(14) V-MUTE button

Turn the picture into black. Press again to resume.

(15) ASPECT (Aspect select) button (P.18)

Selects the aspect ratio. Every time the button is pressed, the selection rotates in the order of FULL → NORMAL → ZOOM → THROUGH.

(16) FULL button (P.18)

Select FULL mode from four aspect ratio modes.

(17) NORMAL button (P.18)

Select NORMAL mode from four aspect ratio modes.

(18) ZOOM button (P.18)

Select ZOOM mode from four aspect ratio modes.

(19) THROUGH button (P.18)

Select THROUGH mode from four aspect ratio modes.

(20) INFO. button (P.33)

Turn the information menu on or off.

(21) THEATER button (P.32)

Select the Theater picture mode.

Theater mode is designed for high fidelity black appearance and is good for movie pictures.

Every time THEATER button is pressed, the selection rotates in the order of Theater 1 → Theater 2 → Theater 3 → Default.

(22) STD button (P.32)

Select the STANDARD picture mode.

Standard mode is good for normal pictures.

Every time the button is pressed, the selection rotates in the order of Standard 1 → Standard 2 → Standard 3 → Default.

(23) CINEMA button

Press to turn the CINEMA mode – auto 3-2 pull down mode – on or off.

(24) USER button (P.32)

Selects the user mode.

The user mode is for enjoying images at a user-selected gamma curve.

Every time the button is pressed, the selection rotates in the order of User A1 → User A2 → User A3 → User B1 → User B2 → User B3 → User C1 → User C2 → User C3.

For more information on how to select gamma curve → (P.32)

(25) DYNA. button (P.32)

Select the Dynamic picture mode.

Dynamic mode is good for visually dynamic pictures.

Every time the button is pressed, the selection rotates in the order of Dynamic 1 → Dynamic 2 → Dynamic 3 → Default.

Remote Controller Operational Range

Operate the remote controller within a distance of approximately 5m from the IR sensor (remote sensor) on the projector.

Remote control operation may not be possible if the remote control unit's transmitter is not pointing in the direction of the remote sensor or if there is an obstruction between the transmitter and the remote sensor.

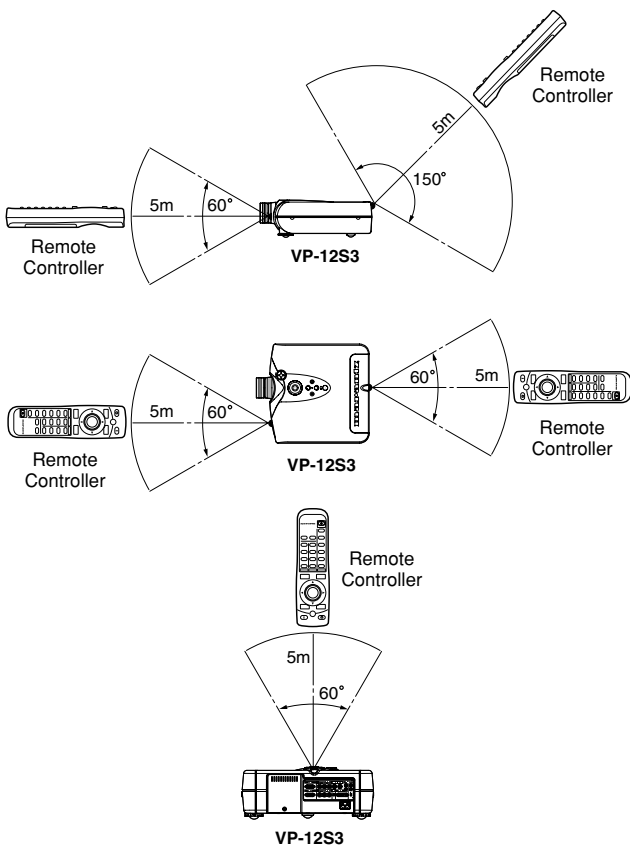

Preparing the Remote Controller

1. Take the cover off the battery case on the remote control backside.

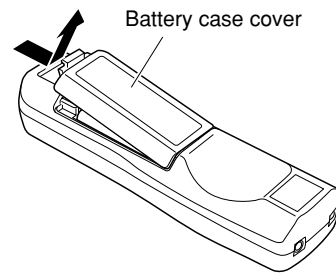

2. Insert two AA size batteries. Make sure the polarities match the + and - marks inside the battery compartment.

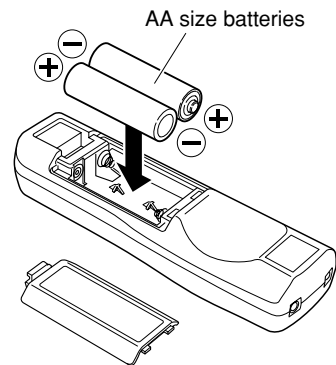

3. Reattach the battery case cover as before.

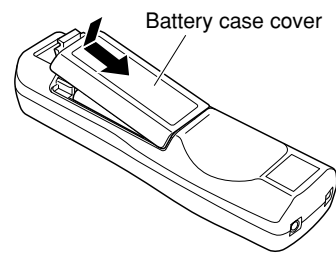

CAUTION

- The available battery types are limited: manganese dry cell and alkaline dry cell.
- Do not mix different battery types.
- Do not mix old and new batteries.
- Only batteries of the same type are to be used.
- Remove exhausted batteries from the Remote Controller.
- Do not attempt to recharge non-rechargeable batteries.
- Do not use rechargeable batteries.
- Batteries are to be inserted with the correct polarity.
- The supply terminals are not to be short-circuited.
- Never throw batteries in a fire or attempt to open up its outer casing.
- If the user does not intend to use the Remote Controller for a long time, remove the batteries.
- Keep away from heat.
- Do not be subjected to strong shock.
- Do not be subjected to moisture. If the unit gets moistured, wipe it off immediately.
- The Remote Controller operation may not function if the projector's IR sensors are exposed to direct sun light or strong artificial light, or if there is an obstacle between the IR sensors and the Remote Controller.

CONNECTION

❖ When making connections be sure to:

- Turn off all equipment before making any connections.
- Use the proper cables for each connection.
- Securely insert the plug into the port to connect cables. Loose cables can lead to trouble and damage.

❖ When pulling out a cable:

- Be sure to grab the plug, not the cable itself.

Connection with AC Power Supply

Connect the supplied AC power cord into the AC IN socket of the projector.

The STANDBY indicator lights up and the projector goes into the standby mode.

Note : Make sure the AC power cord is firmly connected into the AC IN socket.

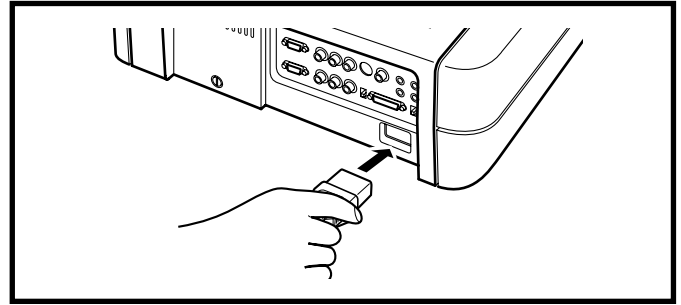

Connection with Video Equipments

You can connect this projector to a VCR, DVD player and other video equipment.

Connecting a video source using S-VIDEO IN and VIDEO IN terminals.

1. Connect one of the S-video cable to the S-VIDEO IN terminal, or one end of the video cable to the VIDEO IN terminal on the projector.
2. Connect the other end of the S-video cable or the video cable to the S-video output terminal or video output terminal of the video source.

Connecting a DVD player to the COMPONENT VIDEO IN 1 or 2 terminal

(Devices can be connected to both terminals at the same time.)

1. Connect the individual terminals of the component video cable into the COMPONENT VIDEO IN 1 or 2 terminal of the projector.
2. Connect the other end of the cable to the corresponding terminals on a DVD player.

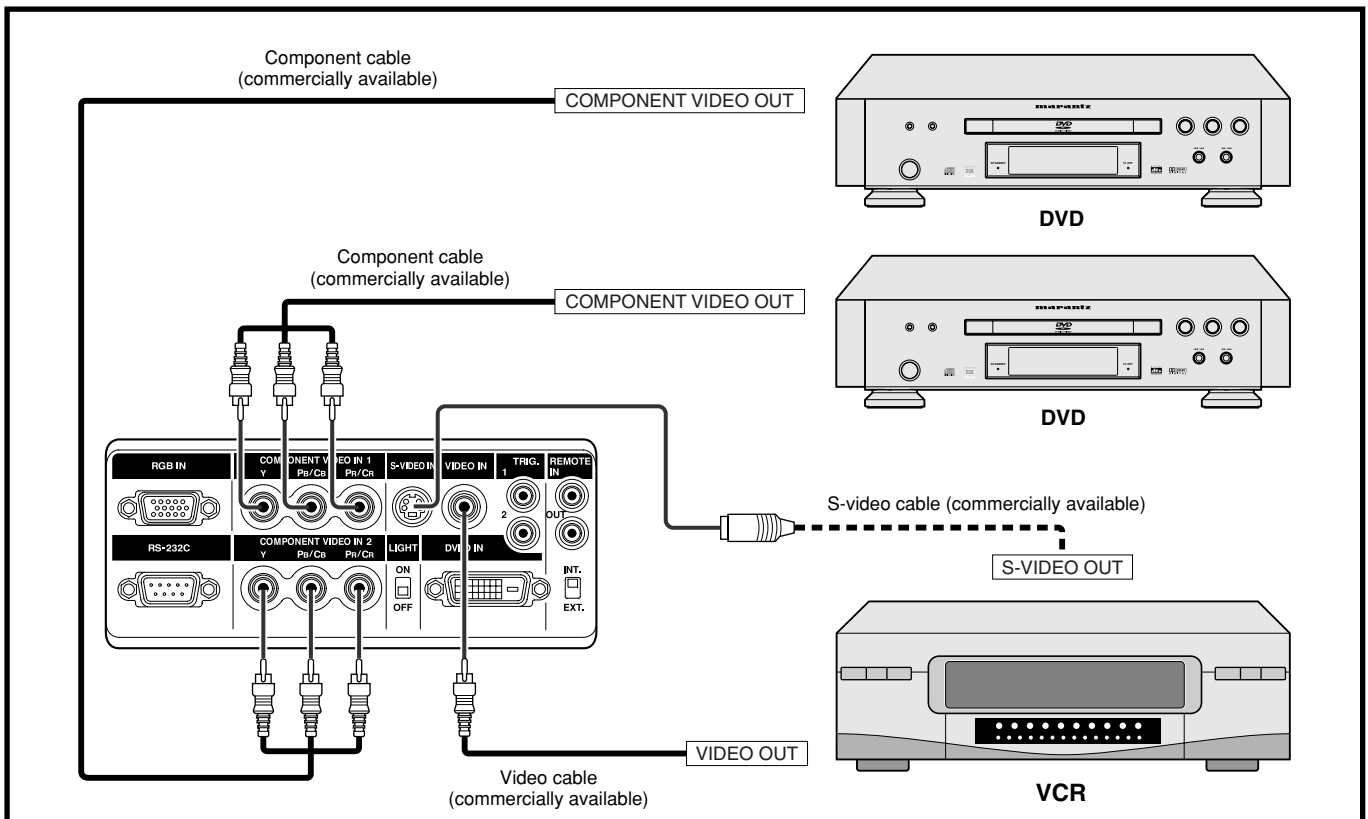

Connection with a HD-Video, Satellite, Cable Tuner or PC

You can connect this projector to HD-Video /PC using RGB IN port, or Satellite /Cable Tuner /PC using DVI-D IN port.

1. Connect one end of the RGB cable to the RGB IN port, or one end of the DVI-D cable to the DVI-D IN port on the projector.
2. Connect the other end to the corresponding port on a HD-Video, Satellite, Cable Tuner or personal computer.

Note : When projecting a video image from a device connected to the DVI-D terminal, follow the procedure below.

1. Turn on power of this unit. (P.18)
2. Set the input video source to AUX (DVI-D input). (P.18)
3. Turn on power of the device connected to the DVI-D terminal of the unit (i.e. DVD player).

If the procedure above is not followed, projected image may corrupt.

For the details of the DVI-D terminal on the device connected with the unit, see the instruction manual of the device.

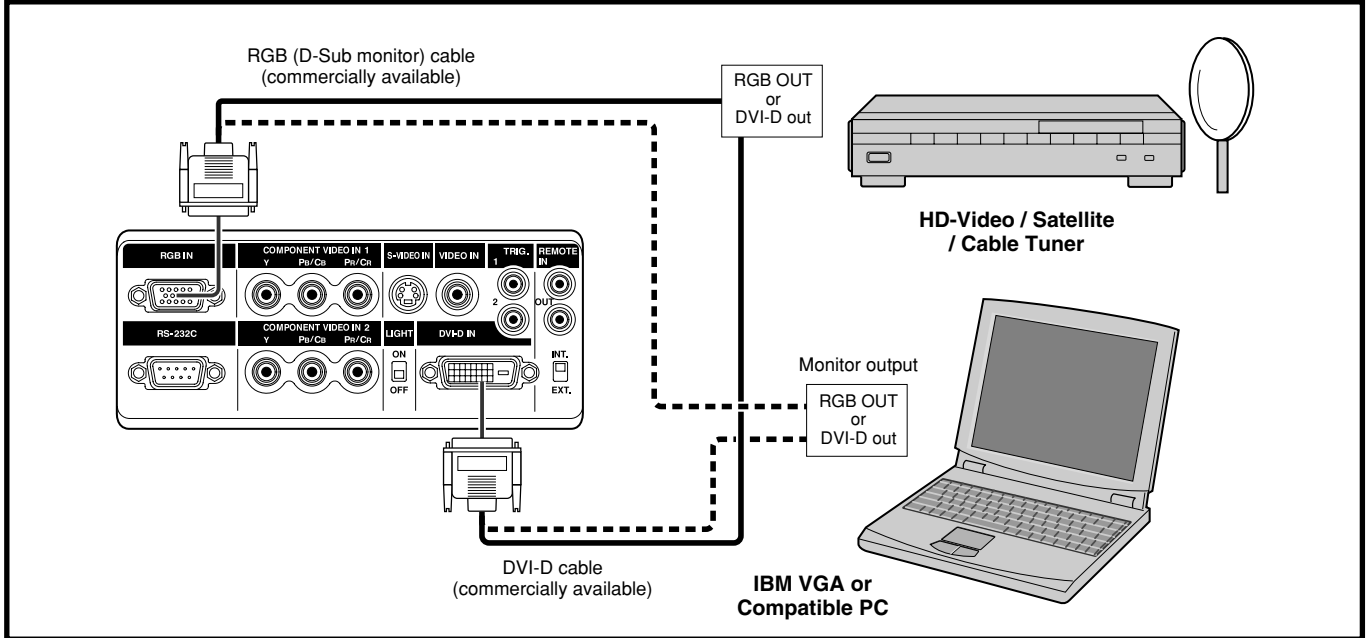

Advanced Connection

You can control total home theater system using PC or Marantz receiver equipment.

For installing below system, consult with Marantz authorized dealer.

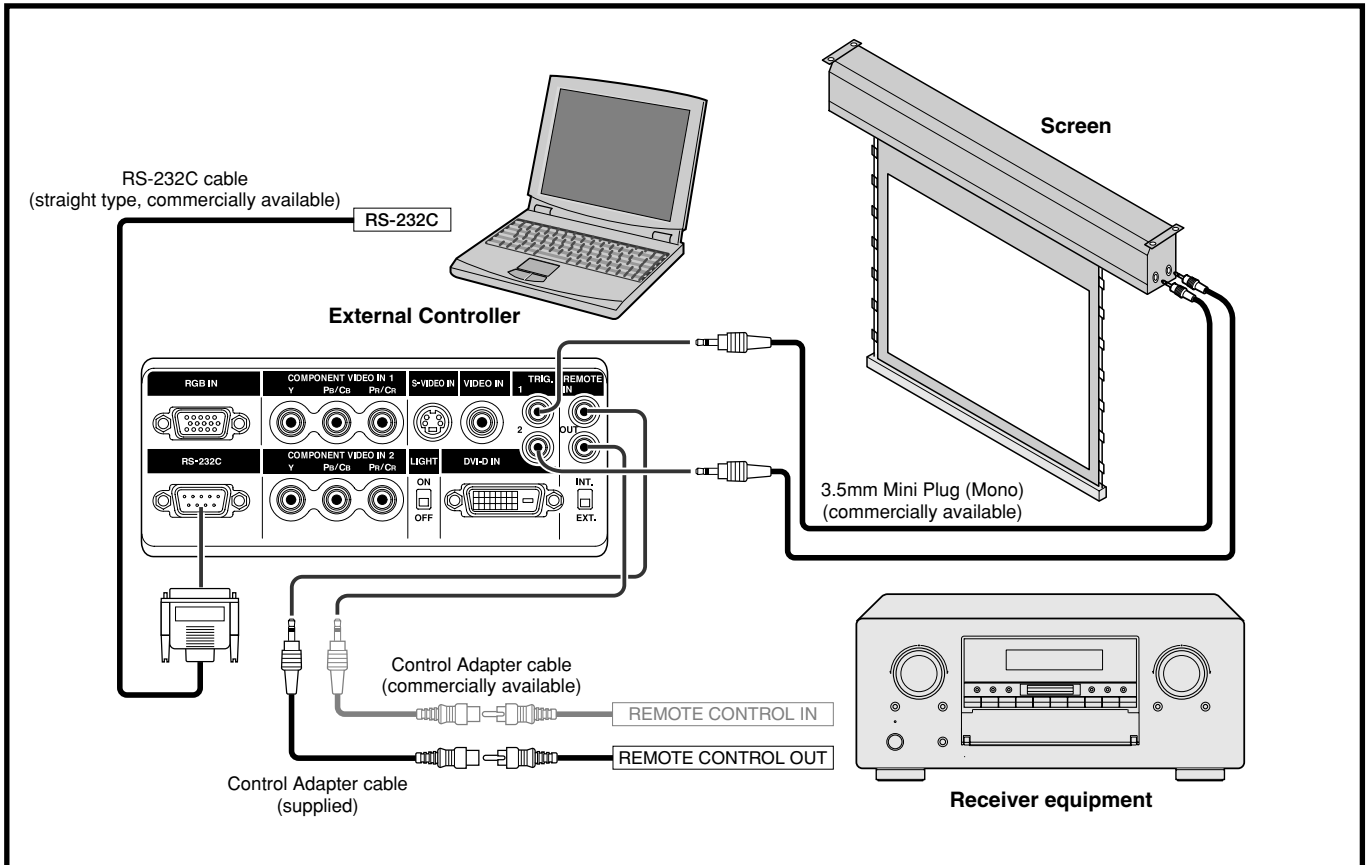

INITIAL SETTING

Turning on the Power

1. Connect the supplied AC power cord. (P.8)
2. Press the **POWER ON** button on the remote controller or the **POWER** button on the projector.
The POWER ON indicator lights up.

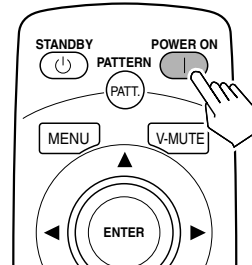
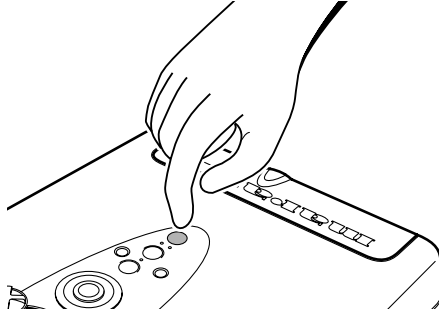

Zooming and Focusing

Project an image on the screen roughly at first.

1. Turn the **Zoom ring** and adjust to the desired size within the zoom range.
2. Turn the **Focus ring** until the image on the screen becomes clear.

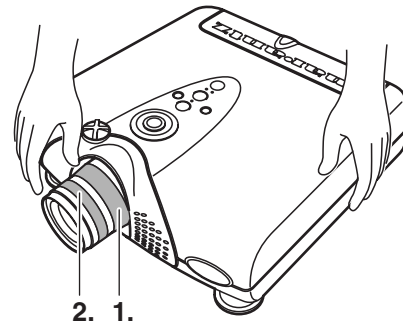

Adjusting the Image Position

You can adjust the image position with the Lens Shift knob.

- ❖ Turn the **Lens Shift knob to clockwise** : The image goes up.

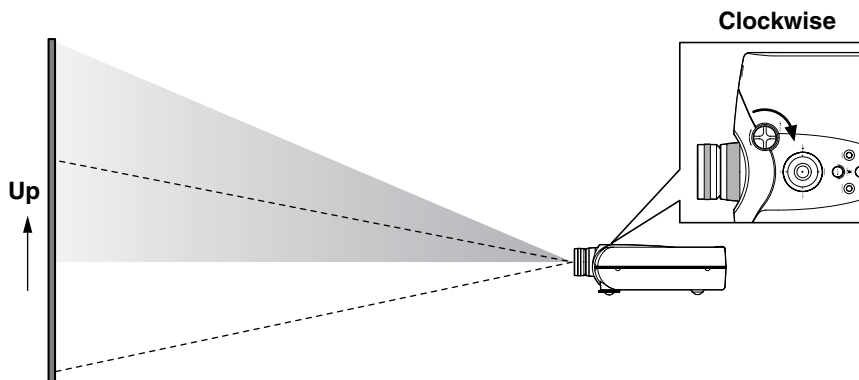

❖ Turn the Lens Shift knob to counterclockwise : The image goes down.

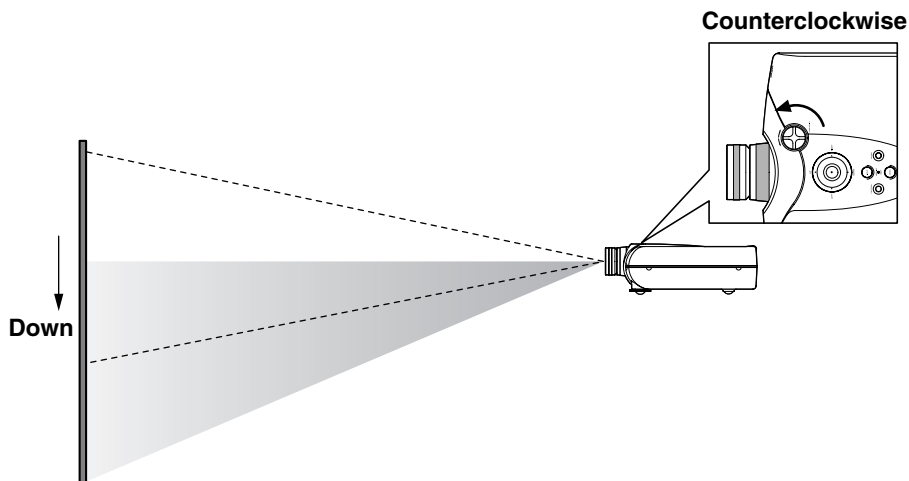

Adjusting the Height

You can position the projected image by changing the height of the projector's adjusters.

1. Move the adjuster lever to the left or right to enable adjuster changing. Carefully lift the projector.

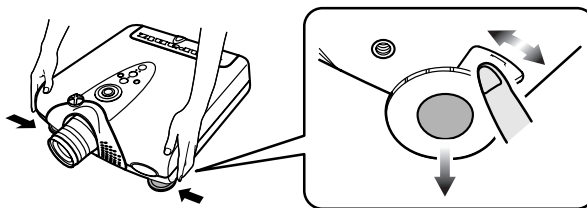

2. Once having positioned the projector, return the adjuster lever as before to lock in place. Check the adjusters are securely locked before releasing your hands from the projector.
3. Turn the adjuster to fine-adjust the height.

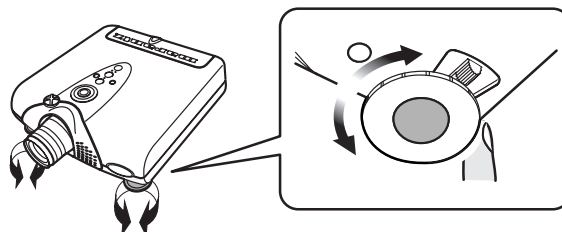

❖ Returning the Projector to its Initial Position

Slightly lift the projector, turn the adjuster lever to the left or right, then carefully set the projector down.

Detail Focusing

You can strictly focus the image with focus pattern.

1. Press the **PATTERN** button to project the focus pattern on the screen.

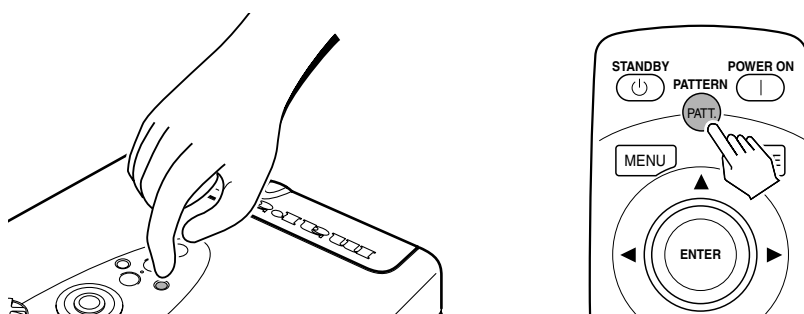

- Turn the **Focus ring** to make an adjustment.
Adjust the focus for the sharpest image possible to obtain, using focus pattern.

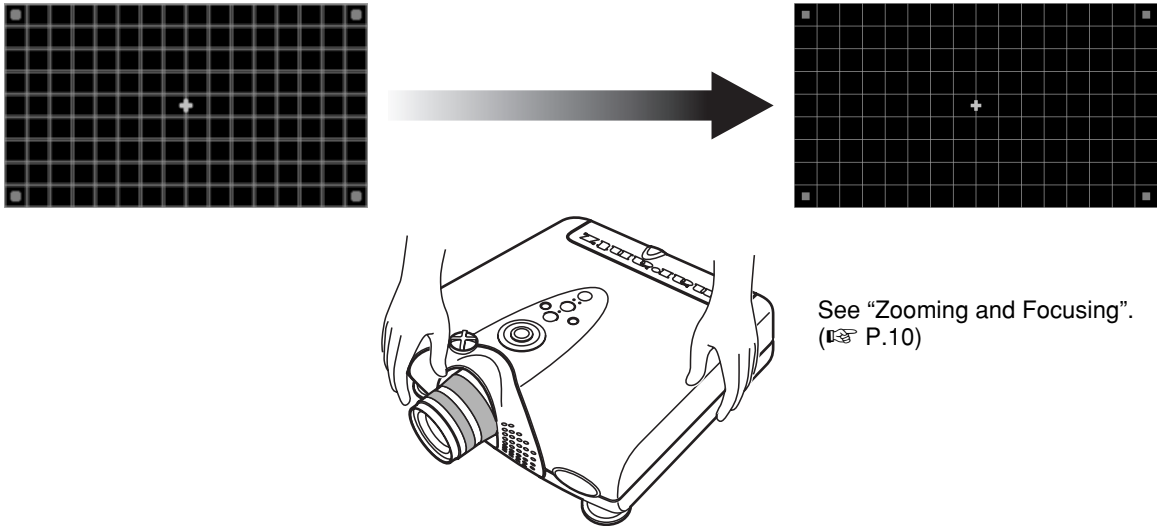

- Press the **PATTERN** button again to hide the focus pattern. This completes fine focusing.

Keystone Correction

When the projecting image is a trapezoid, correct it in Keystone-V and/or Keystone-H in the Display Menu.
See "Display". (P.29)

❖ Keystone-V (Electronic vertical keystone correction)

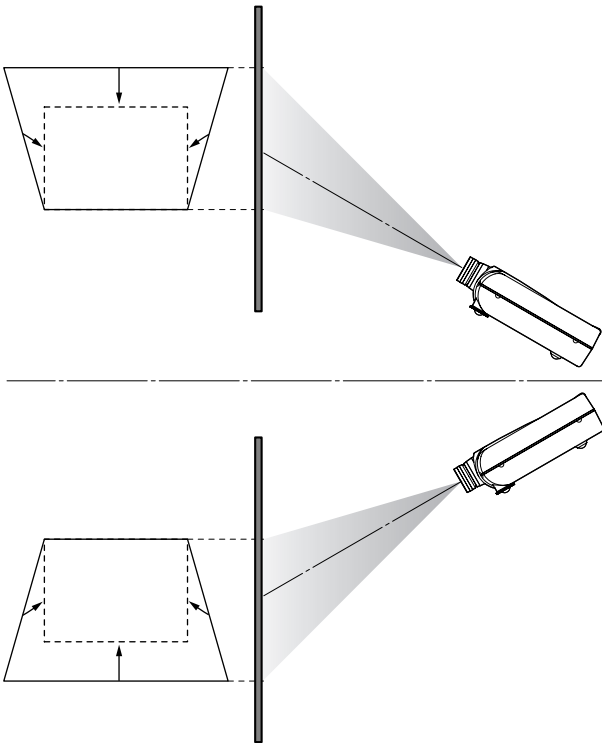

❖ Keystone-H (Electronic horizontal keystone correction)

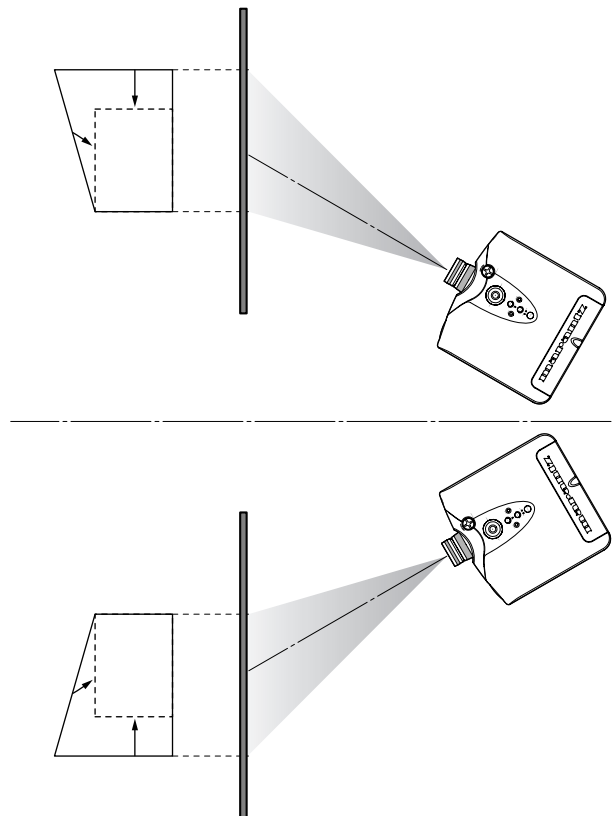

Note : Electronic horizontal keystone correction works properly when the lens shift position is at Full Up.

INSTALLATION

Recommended Setting

❖ Installing on a tabletop

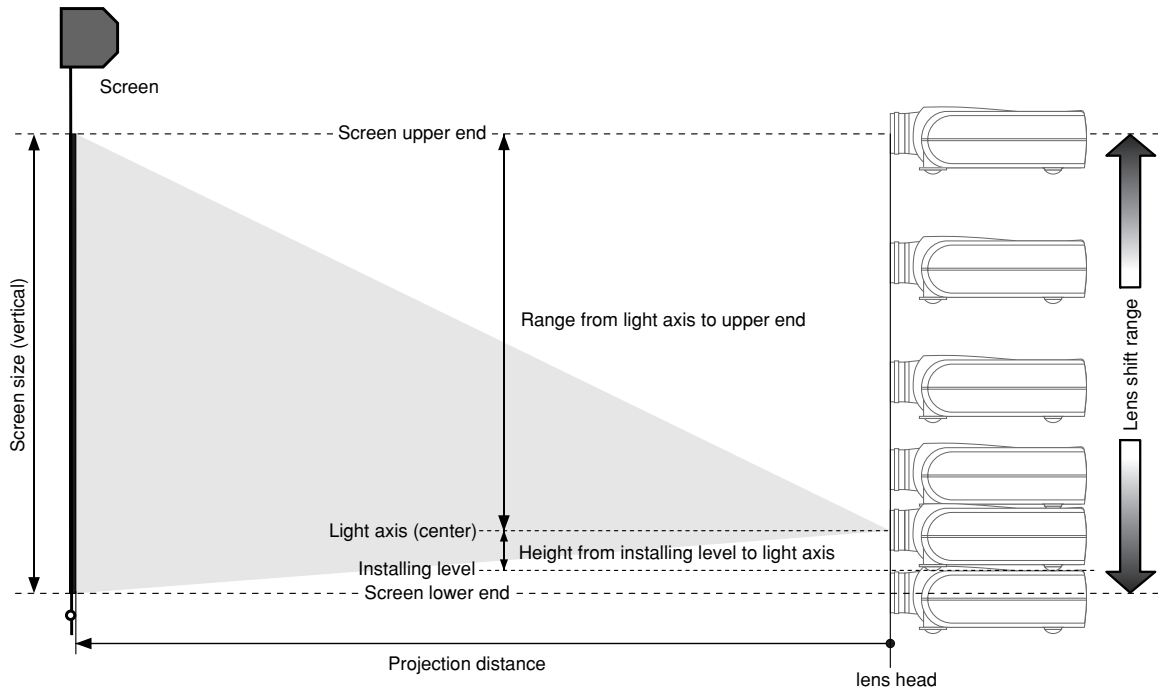

❖ Mounting on the ceiling

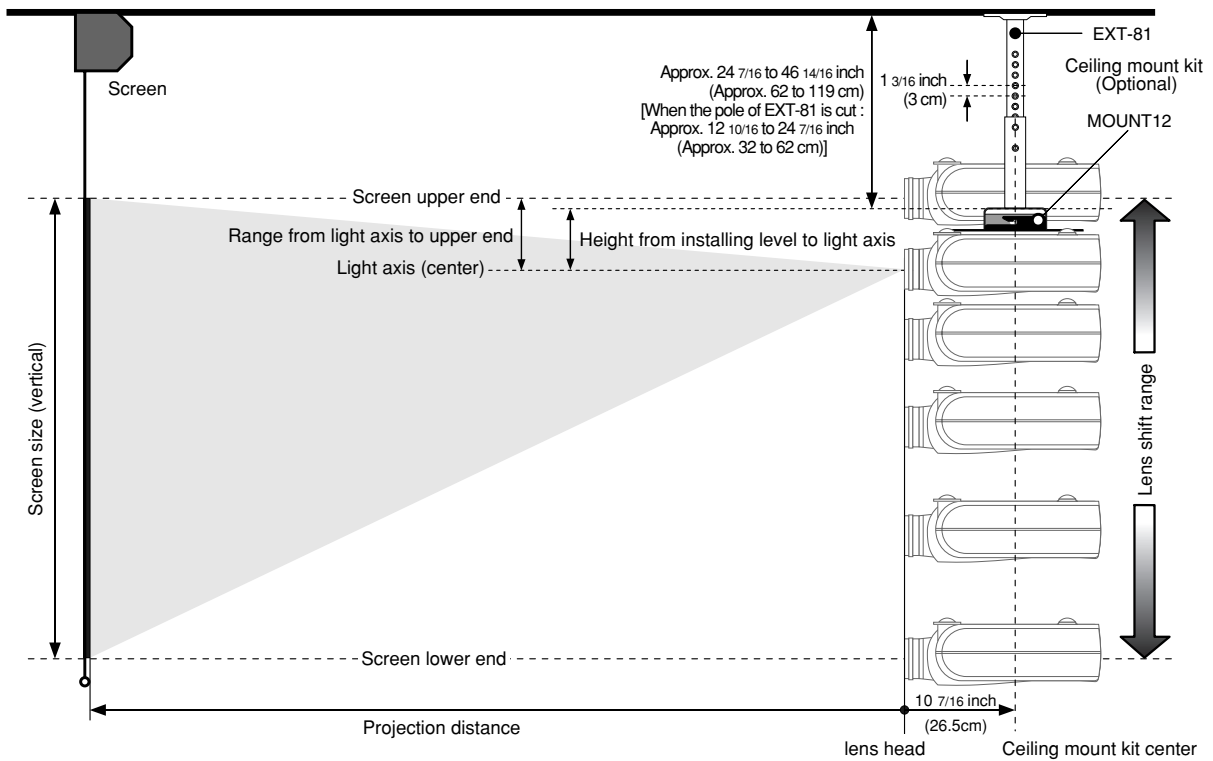

CAUTION

- For ceiling installation, consult with Marantz authorized dealer.
- Do not look into the lens when the projector is turned on. It could damage your eyesight.

Screen Size and Projection Distance (inch) VP-12S3

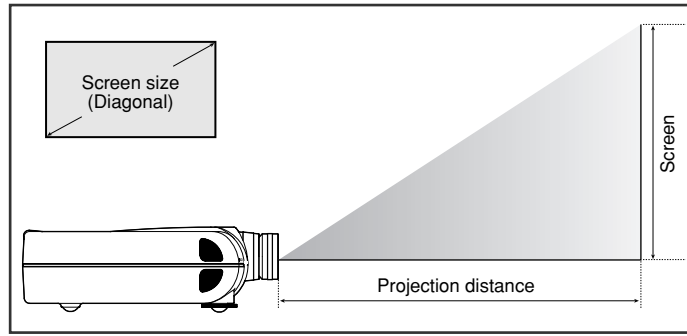

❖ 16 : 9 Screen

In case of displaying the 16:9 picture on the whole of the 16:9 screen.



: Image size = Screen size

16:9 Screen Size (1.77:1 Aspect Ratio)			Projection Distance	
Diagonal	Width	Height	Minimum	Maximum
inch	inch	inch	inch	inch
40	34 7/8	19 5/8	50 7/16	58 11/16
60	52 5/16	29 7/16	76 9/16	89
70	61	34 5/16	89 5/8	104 1/8
72	62 3/4	35 5/16	92 1/4	107 1/8
80	69 3/4	39 1/4	102 3/4	119 1/4
82	71 1/2	40 3/16	105 5/16	122 5/16
84	73 3/16	41 3/16	107 15/16	125 5/16
90	78 7/16	44 1/8	115 13/16	134 3/8
92	80 3/16	45 1/8	118 7/16	137 7/16
100	87 3/16	49	128 7/8	149 9/16
106	92 3/8	51 15/16	136 3/4	158 5/8
110	95 7/8	53 15/16	141 15/16	164 11/16
120	104 9/16	58 13/16	155	179 13/16
123	107 3/16	60 5/16	158 15/16	184 3/8
133	115 15/16	65 3/16	172	199 1/2
135	117 11/16	66 3/16	174 5/8	202 9/16
150	130 3/4	73 9/16	194 1/4	225 1/4
170	148 3/16	83 3/8	220 3/8	255 9/16
200	174 5/16	98 1/16	259 5/8	300 15/16
250	217 7/8	122 9/16	325	376 11/16

To calculate the installation measurement (unit : inch)
 Minimum = $(33.21 \times \text{Screen Size} - 47.6) \div 25.4$
 Maximum = $(38.46 \times \text{Screen Size} - 47.6) \div 25.4$
Note : Tolerance $\pm 5\%$

❖ 4 : 3 Screen

In case of displaying the 16:9 picture on the whole of the 4:3 screen.

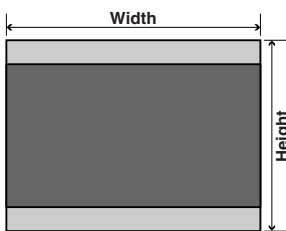

: Image size
 : Screen size

4:3 Screen Size (1.33:1 Aspect Ratio)			Projection Distance	
Diagonal	Width	Height	Minimum	Maximum
inch	inch	inch	inch	inch
40	32	24	46 1/8	53 3/4
60	48	36	70 1/8	81 9/16
70	56	42	82 1/8	95 7/16
72	57 5/8	43 3/16	84 9/16	98 3/16
80	64	48	94 3/16	109 5/16
84	67 3/16	50 3/8	98 15/16	114 7/8
90	72	54	106 3/16	123 1/4
100	80	60	118 3/16	137 1/8
110	88	66	130 3/16	151 1/16
120	96	72	142 3/16	164 15/16
150	120	90	178 3/16	206 5/8
170	136	102	202 3/16	234 7/16
180	144	108	214 3/16	248 3/8
200	160	120	238 3/16	276 3/16
250	200	150	298 1/4	345 11/16

To calculate the installation measurement (unit : inch)
 Minimum = $(30.49 \times \text{Screen Size} - 47.6) \times 1000 \div 25.4$
 Maximum = $(35.31 \times \text{Screen Size} - 47.6) \times 1000 \div 25.4$
Note : Tolerance $\pm 5\%$

Screen Size and Projection Distance (m) VP-12S3

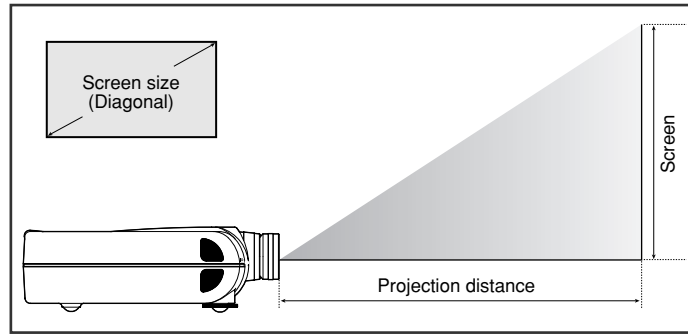

❖ 16 : 9 Screen

In case of displaying the 16:9 picture on the whole of the 16:9 screen.

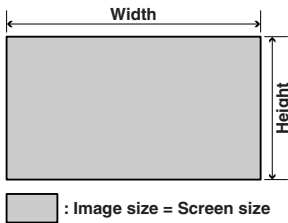

16:9 Screen Size (1.77:1 Aspect Ratio)			Projection Distance	
Diagonal	Width	Height	Minimum	Maximum
inch	mm	mm	m	m
40	886	498	1.28	1.49
60	1328	747	1.95	2.26
70	1550	872	2.28	2.64
72	1594	897	2.34	2.72
80	1771	996	2.61	3.03
82	1815	1021	2.68	3.11
84	1860	1046	2.74	3.18
90	1992	1121	2.94	3.41
92	2037	1146	3.01	3.49
100	2214	1245	3.27	3.80
106	2347	1320	3.47	4.03
110	2435	1370	3.61	4.18
120	2657	1494	3.94	4.57
123	2723	1532	4.04	4.68
133	2944	1656	4.37	5.07
135	2989	1681	4.44	5.14
150	3321	1868	4.93	5.72
170	3763	2117	5.60	6.49
200	4428	2491	6.59	7.64
250	5535	3113	8.25	9.57

To calculate the installation measurement (unit : m)
 Minimum = $(33.21 \times \text{Screen Size} - 47.6) \div 1000$
 Maximum = $(38.46 \times \text{Screen Size} - 47.6) \div 1000$
Note : Tolerance $\pm 5\%$

❖ 4 : 3 Screen

In case of displaying the 16:9 picture on the whole of the 4:3 screen.

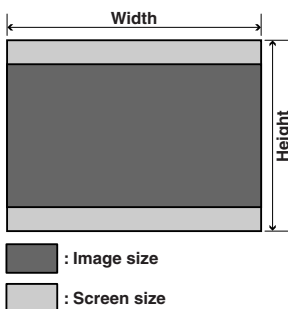

4:3 Screen Size (1.33:1 Aspect Ratio)			Projection Distance	
Diagonal	Width	Height	Minimum	Maximum
inch	mm	mm	m	m
40	813	610	1.17	1.36
60	1219	914	1.78	2.07
70	1422	1067	2.09	2.42
72	1463	1097	2.15	2.49
80	1626	1219	2.39	2.78
84	1707	1280	2.51	2.92
90	1829	1372	2.70	3.13
100	2032	1524	3.00	3.48
110	2235	1676	3.31	3.84
120	2438	1829	3.61	4.19
150	3048	2286	4.53	5.25
170	3454	2591	5.14	5.96
180	3658	2743	5.44	6.31
200	4064	3048	6.05	7.01
250	5080	3810	7.57	8.78

To calculate the installation measurement (unit : m)
 Minimum = $(30.49 \times \text{Screen Size} - 47.6) \div 1000$
 Maximum = $(35.31 \times \text{Screen Size} - 47.6) \div 1000$
Note : Tolerance $\pm 5\%$

Screen Size and Projection Distance (inch) VP-12S3L

ENGLISH

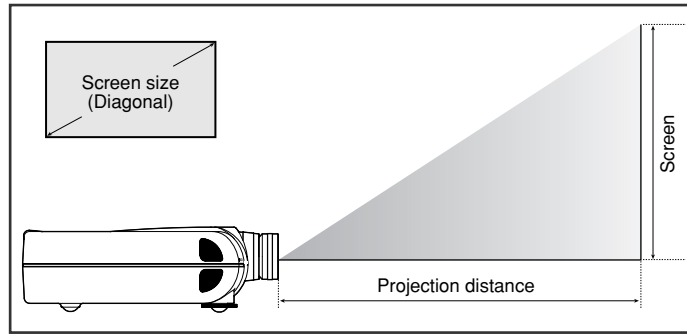

❖ 16 : 9 Screen

In case of displaying the 16:9 picture on the whole of the 16:9 screen.

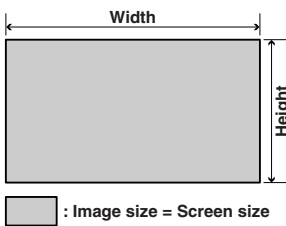

16:9 Screen Size (1.77:1 Aspect Ratio)			Projection Distance	
Diagonal	Width	Height	Minimum	Maximum
inch	inch	inch	inch	inch
40	34 7/8	19 5/8	78 9/16	107 1/16
60	52 5/16	29 7/16	118 7/8	161 11/16
70	61	34 5/16	139 1/16	189
72	62 3/4	35 5/16	143 1/8	194 1/2
80	69 3/4	39 1/4	159 1/4	216 5/16
82	71 1/2	40 3/16	163 5/16	221 13/16
84	73 3/16	41 3/16	167 5/16	227 1/4
90	78 7/16	44 1/8	179 7/16	243 5/8
92	80 3/16	45 1/8	183 1/2	249 1/8
100	87 3/16	49	199 5/8	270 15/16
106	92 3/8	51 15/16	211 6/8	287 3/8
110	95 7/8	53 15/16	219 13/16	298 1/4
120	104 9/16	58 13/16	240	325 9/16
123	107 3/16	60 5/16	246 1/16	333 13/16
133	115 15/16	65 3/16	266 1/4	361 1/8
135	117 11/16	66 3/16	270 1/4	366 9/16
150	130 3/4	73 9/16	300 1/2	407 9/16
170	148 3/16	83 3/8	340 7/8	462 3/16
200	174 5/16	98 1/16	401 7/16	544 1/8
250	217 7/8	122 9/16	502 5/16	680 11/16

To calculate the installation measurement (unit : inch)
 Minimum = (2 x Screen Size - 2 3/16)
 Maximum = (2 3/4 x Screen Size - 2 3/16)
 Note : Tolerance ±5%

❖ 4 : 3 Screen

In case of displaying the 16:9 picture on the whole of the 4:3 screen.

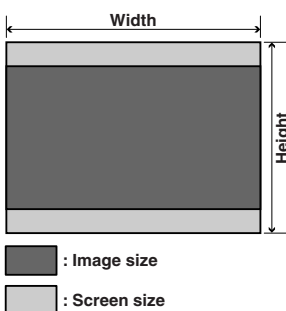

4:3 Screen Size (1.33:1 Aspect Ratio)			Projection Distance	
Diagonal	Width	Height	Minimum	Maximum
inch	inch	inch	inch	inch
40	32	24	71 15/16	98 1/8
60	48	36	109	148 5/16
70	56	42	127 1/2	173 3/8
72	57 5/8	43 3/16	131 3/16	178 3/8
80	64	48	146 1/16	198 7/16
84	67 3/16	50 3/8	153 7/16	208 1/2
90	72	54	164 9/16	223 1/2
100	80	60	183 1/16	248 5/8
110	88	66	201 5/8	273 11/16
120	96	72	220 1/8	298 3/4
150	120	90	275 3/4	374
170	136	102	312 3/4	424 1/8
180	144	108	331 5/16	449 1/4
200	160	120	368 3/8	499 3/8
250	200	150	461	624 3/4

To calculate the installation measurement (unit : inch)
 Minimum = (2 x Screen Size - 2 3/16)
 Maximum = (2 3/4 x Screen Size - 2 3/16)
 Note : Tolerance ±5%

Screen Size and Projection Distance (mm) VP-12S3L

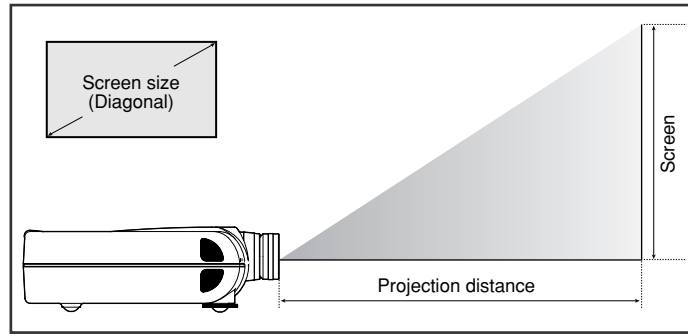

❖ 16 : 9 Screen

In case of displaying the 16:9 picture on the whole of the 16:9 screen.

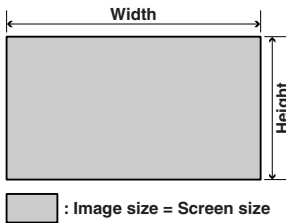

16:9 Screen Size (1.77:1 Aspect Ratio)			Projection Distance	
Diagonal	Width	Height	Minimum	Maximum
inch	mm	mm	mm	mm
40	886	498	1,995	2,720
60	1328	747	3,020	4,107
70	1550	872	3,533	4,801
72	1594	897	3,635	4,940
80	1771	996	4,045	5,495
82	1815	1021	4,148	5,634
84	1860	1046	4,250	5,772
90	1992	1121	4,558	6,189
92	2037	1146	4,660	6,327
100	2214	1245	5,070	6,882
106	2347	1320	5,378	7,299
110	2435	1370	5,583	7,576
120	2657	1494	6,096	8,270
123	2723	1532	6,249	8,478
133	2944	1656	6,762	9,172
135	2989	1681	6,865	9,311
150	3321	1868	7,633	10,351
170	3763	2117	8,659	11,739
200	4428	2491	10,196	13,820
250	5535	3113	12,759	17,289

To calculate the installation measurement (unit : mm)
 Minimum = (51.26 x Screen Size - 55.56)
 Maximum = (69.38 x Screen Size - 55.56)
 Note : Tolerance ±5%

❖ 4 : 3 Screen

In case of displaying the 16:9 picture on the whole of the 4:3 screen.

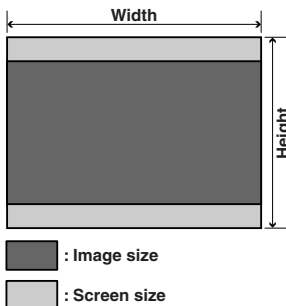

4:3 Screen Size (1.33:1 Aspect Ratio)			Projection Distance	
Diagonal	Width	Height	Minimum	Maximum
inch	mm	mm	mm	mm
40	813	610	1,827	2,492
60	1219	914	2,768	3,766
70	1422	1067	3,239	4,403
72	1463	1097	3,333	4,531
80	1626	1219	3,709	5,040
84	1707	1280	3,897	5,295
90	1829	1372	4,180	5,677
100	2032	1524	4,650	6,314
110	2235	1676	5,121	6,951
120	2438	1829	5,592	7,588
150	3048	2286	7,003	9,499
170	3454	2591	7,945	10,773
180	3658	2743	8,415	11,410
200	4064	3048	9,356	12,684
250	5080	3810	11,709	15,869

To calculate the installation measurement (unit : mm)
 Minimum = (47.06 x Screen Size - 55.56)
 Maximum = (63.70 x Screen Size - 55.56)
 Note : Tolerance ±5%

BASIC OPERATIONS

Turning on the Power

Press the **POWER ON** button on the remote controller or the **POWER** button on the projector.
The POWER ON indicator lights up.

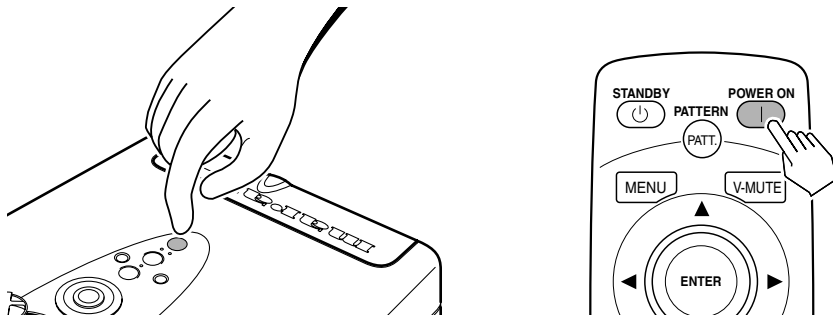

Selecting the Input Signal Source

Switch to the equipment connected to the projector.

Pressing the **INPUT** button on the projector or remote control rotates the input signal in the order of COMPONENT1 → COMPONENT2 → S-VIDEO → VIDEO → RGB → AUX, allowing you to select an input signal. An input signal can also be directly selected by pressing one of the **COMP.1**, **COMP.2**, **S-VIDEO**, **VIDEO**, **RGB** and **AUX** buttons on the remote control.

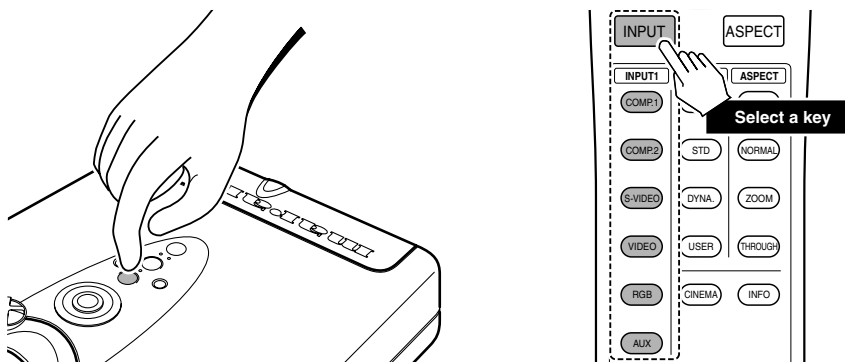

Selecting the Aspect Mode

You can select 4 kinds of ASPECT mode using remote controller.

Pressing the **ASPECT** button on the remote control rotates the aspect ratio in the order of FULL → NORMAL → ZOOM → THROUGH, allowing you to select an aspect ratio. An aspect ratio can also be directly selected by pressing one of the **FULL**, **NORMAL**, **ZOOM** and **THROUGH** buttons on the remote control, or it can be selected from the menu. (☞ P.27)

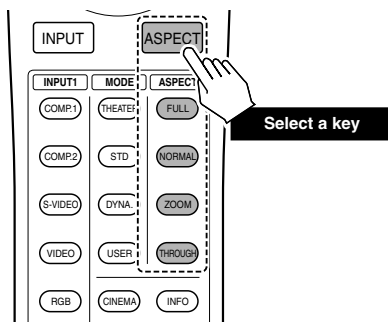

The Screen Images in a 16:9 screen

- Press the **ZOOM** button, the **NORMAL** button or the **FULL** button on the remote controller for the 4:3 aspect ratio video source.
- Press the **FULL** button on the remote controller for 16:9 aspect ratio video source, such as 1080i, 1035i, and 720p video systems.
- Press the **FULL** button on the remote controller for the squeezed video source.

See "Setting". (P.27)

❖ Original Source Image

16 : 9 video source

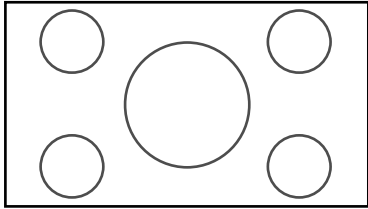

4 : 3 video source

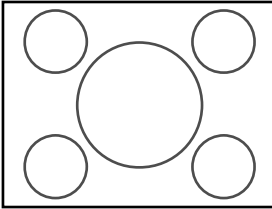

❖ Full mode

The 16:9 squeezed image is displayed with the correct aspect.

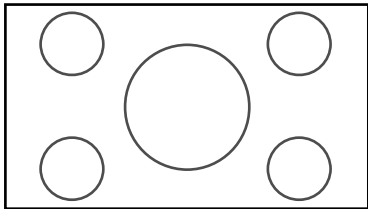

The 4:3 image is enlarged horizontally.

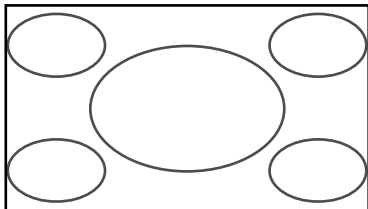

❖ Normal mode

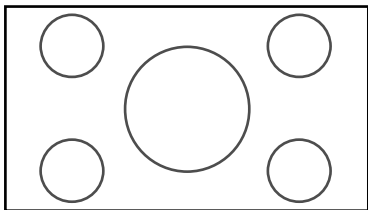

The picture in normal ratio 4:3 is displayed.

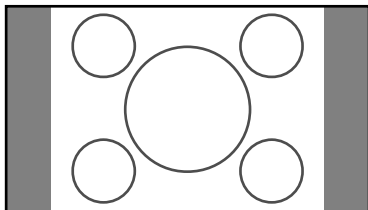

❖ Zoom mode

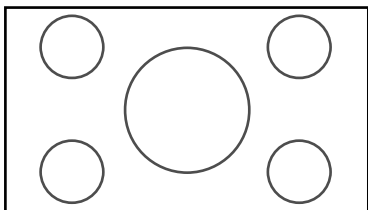

The picture in normal ratio 4:3 is enlarged vertically and horizontally (with same ratio) to the screen size

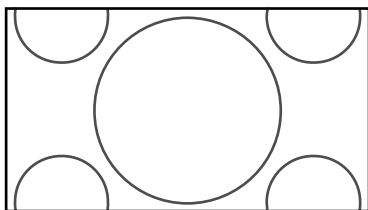

❖ Through mode

It shows an image when the video source has the same resolution to RGB/video signal with 720 or less vertical pixel number.

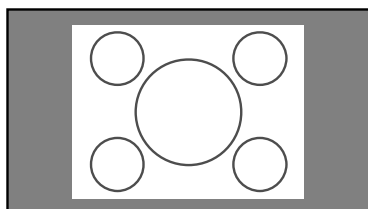
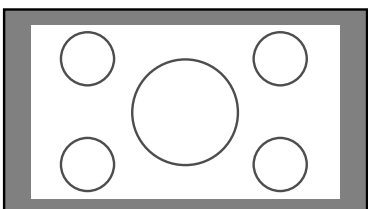

The Screen Images in a 4:3 screen

- Press the **ZOOM** button, the **NORMAL** button or the **FULL** button on the remote controller for the 4:3 aspect ratio video source.
 - Press the **FULL** button on the remote controller for 16:9 aspect ratio video source, such as 1080i, 1035i, and 720p video systems.
 - Press the **FULL** button on the remote controller for the squeezed video source.
- See "Setting". (P.27)

❖ Original Source Image

16 : 9 video source

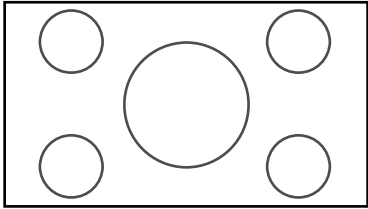

4 : 3 video source

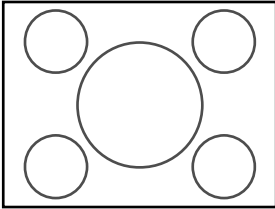

❖ Full mode

The 16:9 squeezed image is displayed with the correct aspect.

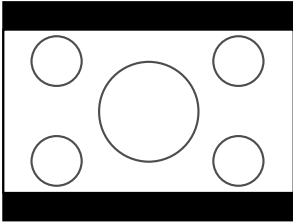

The 4:3 image is enlarged horizontally.

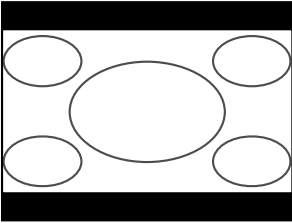

❖ Normal mode

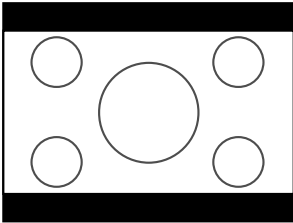

The picture in normal ratio 4:3 is displayed.

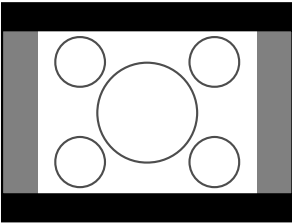

❖ Zoom mode

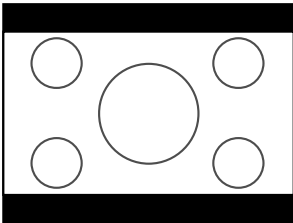

The picture in normal ratio 4:3 is enlarged vertically and horizontally (with same ratio) to the screen size

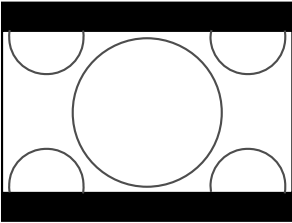

❖ Through mode

It shows an image when the video source has the same resolution to RGB/video signal with 720 or less vertical pixel number.

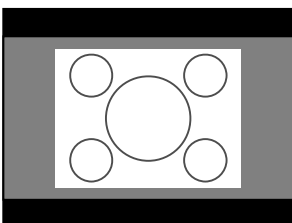
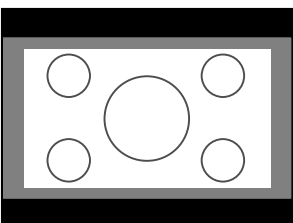

To Turn off the Power

1. Press the **STANDBY** button on the remote controller or the **POWER** button on the projector.
2. The fan continues running for about 1 minute to internally cool the projector. In the meantime, the POWER ON indicator on the projector flashes a blue color and buttons on the projector and remote control are irresponsive to touch. Once the fan stops, the POWER ON indicator goes out and the STANDBY indicator lights up a red color to indicate the projector is on standby.

Notice : Do not pull out the AC power cord until the projector turns in standby mode.

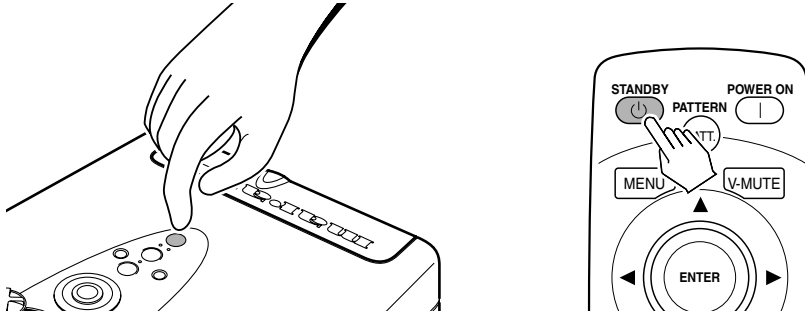

Notice :

- Do not pull out the power cord suddenly in the state of "POWER ON." It can cause a breakdown.
- When a WARNING indicator lit up or blinks in red, pull out the AC power cord after checking that the fan has stopped.
- The projector will not be turned on if the **POWER ON** button on the remote controller or the **POWER** button on the projector is pressed immediately after turning off. Press the **POWER ON** button on the remote controller or **POWER** button on the projector after the projector turns into standby mode.
- When on standby, power to the projector is not OFF completely. If not planning to use the projector for an extended period of time, unplug the AC power cord from AC power outlet as explained above.

OPERATIONS

Menu Structure

Main Menu	Item	Value
* Picture Adjust P.24	Contrast	0 ↔ 100
	Brightness	0 ↔ 63
	* Color	0 ↔ 100
	* Sharpness	0 ↔ 31
	* Tint	R50 ↔ G50
	* Noise Reduction	0 ↔ 63
	* Color Temp. (Temperature)	1 ↔ 5
	Fine Menu	

Setting	Item	Value	
Setting P.27	Lamp mode	High / Low	
	High Bright	On / Off	
	Aspect	Full	
		Normal	
		Through	
		Zoom	
	* VCR Mode	On / Off	
	* Cinema	Auto / Off	
Iris	F5.0 / F3.0		
* Black Setup	0IRE / 7.5IRE		

During DVI input, "NORMAL" or "EXPAND" is shown.

System	Item	Value	
System P.28	Component 1	Auto	
		NTSC	
		PAL	
		480p	
		540p	
		576p	
		720p	
		1035i	
	1080i		
	Component 2	Auto	
		NTSC	
		PAL	
		480p	
		540p	
		576p	
		720p	
		1035i	
	1080i		
	S-Video System	Auto	
		NTSC	
		PAL	
		SECAM	
	Video System	Auto	
		NTSC	
		PAL	
		SECAM	
	RGB System	Auto	
		NTSC	
PAL			
480p			
540p			
576p			
720p			
1035i			
1080i			
DVI System	RGB		
	Y Pb Pr		
	Y Cb Cr		

Fine Menu	Item	Value	
* Luminance	H Detail Gain	0 ↔ 31	
	H Detail Threshold	0 ↔ 31	
	H Edge Gain	0 ↔ 31	
	H Edge Threshold	0 ↔ 31	
	V Detail Gain	0 ↔ 31	
	V Detail Threshold	0 ↔ 31	
	V Edge Gain	0 ↔ 31	
	V Edge Threshold	0 ↔ 63	
	* Chrominance	H Edge Gain	0 ↔ 31
		H Edge Threshold	0 ↔ 31
V Edge Gain		0 ↔ 31	
* Enhancement		0 ↔ 31	
Delay		-3 ↔ 0 ↔ +3	
Sub Control	Contrast Red	0 ↔ 255	
	Contrast Green	0 ↔ 255	
	Contrast Blue	0 ↔ 255	
	Brightness Red	0 ↔ 255	
	Brightness Green	0 ↔ 255	
	Brightness Blue	0 ↔ 255	
	* Clamp Position	-128 ↔ 127	
	* Clamp Width	-128 ↔ 127	
Miscellaneous	* DCDi	On / Off	
	FRC	Auto / On	
	* CCS	On / Off	
	* Sharpness Filter	0 ↔ 4	

Main Menu	Item	Value
* Display P.29	Keystone V (Vertical)	-30 ↔ 0 ↔ 30
	Keystone H (Horizontal)	-9 ↔ 0 ↔ 9
	* Auto Adjust	Yes / No
	* Picture Shift V (Vertical)	-50 ↔ 0 ↔ 50
	* Size V (Vertical)	-50 ↔ 0 ↔ 50
	* Picture Shift H (Horizontal)	-50 ↔ 0 ↔ 50
	* Size H (Horizontal)	-50 ↔ 0 ↔ 50
	* Phase	0 ↔ 31

Config (Configuration)	Item	Value	
Config (Configuration) P.30	Auto Power Off	Enable / Disable	
	OSD Position	16 : 9	
		4 : 3	
		Through	
	Language	English	
		German	
		French	
		Spanish	
		Italian	
	Portuguese		
	Ceiling	On / Off	
	Rear	On / Off	
	* Color Temp. Calibration	Yes / No	
	Reset Lamp Life	Yes / No	
	Reset All	Yes / No	

Trigger 2	Item	Value
Trigger 2 P.31	Full	On / Off
	Normal	On / Off
	Zoom	On / Off
	Through	On / Off

Preset	Item	Value
* Preset P.32	Mode	Theater/ Standard/ Dynamic/ UserA/ UserB/ UserC
	* Gamma	A/ B/ C/ D/ E/ a/ b/ c
	Index	1 / 2 / 3 / Default

* : The menu item does not appear or adjustment is not possible with some input signals and settings.

How to Operate Menu

This projector has menus that make setting and adjustment easy.

1. Press the **MENU** button. The MENU screen appears on the screen.

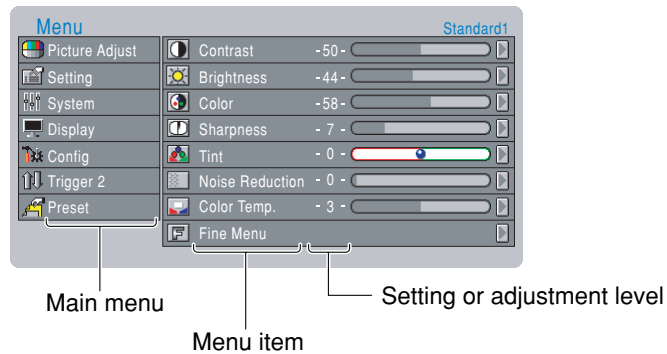

2. Use the ▲ and ▼ buttons to select a menu (Picture Adjust, Setting, System, Display, Configuration, Trigger2, Preset) and press the ► button.
3. Use the ▲ and ▼ buttons to select a menu item and press the ► button.
4. Use the ▲, ▼, ◀ and ▶ buttons to make the setting or adjustment of the selected item.
 - The current setting or adjustment level is displayed to the right of each menu item.
5. Press the **MENU** button again to close the menu.

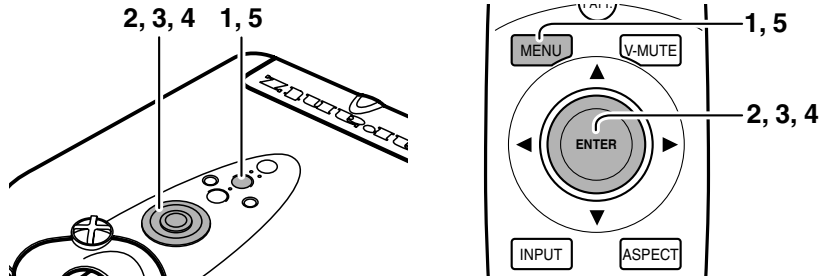

❖ Picture Mode and Memory

This projector offers 6 picture modes: Theater, Standard, Dynamic, User A, User B and User C. Select an picture mode by pressing the **THEATER**, **STD**, **DYNA**. or **USER** buttons on the remote control. Moreover, each of these picture modes has 3 indexes for memorizing picture quality adjustments.

Picture mode	Index
Theater	1, 2, 3, Default
Standard	1, 2, 3, Default
Dynamic	1, 2, 3, Default
User A	1, 2, 3
User B	1, 2, 3
User C	1, 2, 3

As suggested by the above table, adjust picture quality to your liking and memorize it in indexes 1, 2 and 3. See "Preset". (P.32)

Picture Adjust

Picture quality in each of the picture modes can be adjusted to your liking and those adjustments can be saved in memory. This projector makes 3 memory indexes available for each of the picture modes.

❖ For a video signal input, the following adjustments can be made:

Item	Adjustments
Contrast	0 \longleftrightarrow 100
	Weak \longleftrightarrow Strong
Brightness	0 \longleftrightarrow 63
	Dark \longleftrightarrow Bright
Color	0 \longleftrightarrow 100
	Light \longleftrightarrow Deep
Sharpness	0 \longleftrightarrow 31
	Soft \longleftrightarrow Sharp
Tint	R50 \longleftrightarrow G50
	Purple \longleftrightarrow Green
Noise Reduction	0 \longleftrightarrow 63
	Weak \longleftrightarrow Strong
Color Temp. (Color Temperature)	1 2 3 4 5
	Red \longleftrightarrow Blue

NOTE:

- You cannot adjust Tint in Component signal (YCbCr/YPbPr) or PAL format signal.
- When the index is set to default, picture quality cannot be selected. To adjust picture quality, set the index to 1 - 3. See "Preset". (P.32)

❖ Contrast



❖ Color Temp. (Temperature)

- 1 : Red comes out strong. Color temperature is about 5250 K.
- 2 : Red is mildly strong. Color temperature is about 5800 K.
- 3 : Normal. Color temperature is about 6500 K.
- 4 : Blue is mildly strong. Color temperature is about 7500 K.
- 5 : Blue comes out strong. Color temperature is about 9300 K.



❖ Setting the Picture Adjust Menu

1. Select the desired menu item and press the \blacktriangleright button.
An adjustment bar appears on the screen.
2. Press the \blacktriangleleft and \blacktriangleright buttons to adjust picture quality.
3. Press the \blacktriangleup button to enter the adjustment and return to menu item selection.

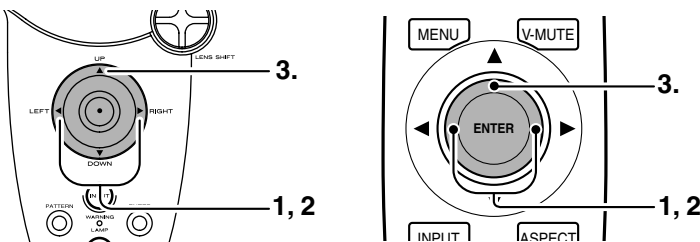

Fine Menu

By adjusting this Fine Menu, you can make fine picture adjustment.

Note : There are some parameters can not adjust according to input signal.

❖ Luminance

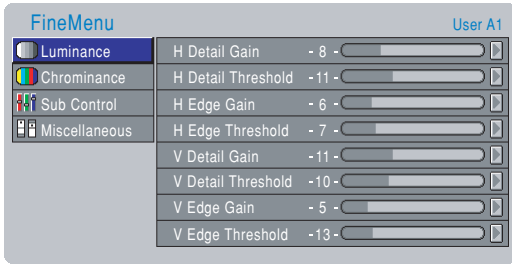

Item	Adjustments
H Detail Gain	0 ↔ 31
H Detail Threshold	0 ↔ 31
H Edge Gain	0 ↔ 31
H Edge Threshold	0 ↔ 31
V Detail Gain	0 ↔ 31
V Detail Threshold	0 ↔ 31
V Edge Gain	0 ↔ 31
V Edge Threshold	0 ↔ 63

H Detail Gain (Horizontal Detail Processing Gain)

: This menu allows the users to set the horizontal detail processing gain.

H Detail Threshold (Horizontal Detail processing Threshold)

: This menu allows the users to set the lower threshold for horizontal detail processing.

H Edge Gain (Horizontal Large Edge Enhancement Gain)

: This menu allows the users to set the horizontal large edge enhancement.

H Edge Threshold (Horizontal Large Edge Enhancement Threshold)

: This menu allows the users to set the lower threshold for horizontal large edge enhancement.

V Detail Gain (Vertical Detail Processing Gain)

: This menu allows the users to set the vertical detail processing gain.

V Detail Threshold (Vertical Detail Processing Threshold)

: This menu allows the users to set the lower threshold for vertical detail processing.

V Edge Gain (Vertical Large Edge Enhancement Gain)

: This menu allows the users to set the vertical large edge enhancement.

V Edge Threshold (Vertical Large Edge Enhancement Threshold)

: This menu allows the users to set the lower threshold for vertical large edge enhancement.

Note : If it is hard to see the effect, make the sharpness higher and adjust it.

❖ Chrominance

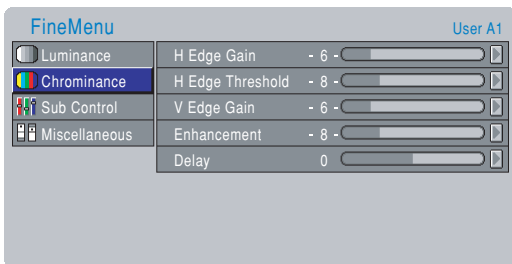

Item	Adjustments
H Edge Gain	0 ↔ 31
H Edge Threshold	0 ↔ 31
V Edge Gain	0 ↔ 31
Enhancement	0 ↔ 31
Delay	-3 ↔ 0 ↔ +3

H Edge Gain (Horizontal Large Edge Enhancement Gain)

: This menu allows the users to set the horizontal large edge enhancement.

H Edge Threshold (Horizontal Large Edge Enhancement Threshold)

: This menu allows the user to set the lower threshold for horizontal large edge enhancement.

V Edge Gain (Vertical Large Edge Enhancement Gain)

: This menu allows the users to set the vertical large edge enhancement.

Enhancement (Enhancer Gain)

: This menu allows the users to set the over all enhancement level.

Delay

: This menu allows the users to set the delay.

❖ Sub Control

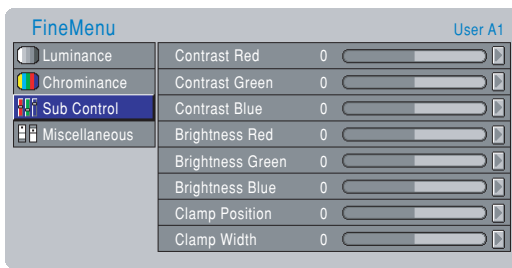

Item	Adjustments
Contrast Red	0 ← → 255
Contrast Green	0 ← → 255
Contrast Blue	0 ← → 255
Brightness Red	0 ← → 255
Brightness Green	0 ← → 255
Brightness Blue	0 ← → 255
Clamp Position	-128 ← → 127
Clamp Width	-128 ← → 127

Contrast Red

: This menu allows the users to set the contrast for red.

Contrast Green

: This menu allows the users to set the contrast for green.

Contrast Blue

: This menu allows the users to set the contrast for blue.

Brightness Red

: This menu allows the users to set the brightness for red.

Brightness Green

: This menu allows the users to set the brightness for green.

Brightness Blue

: This menu allows the users to set the brightness for blue.

Clamp Position

: Adjusts the clamp position used in RGB input.

Clamp Width

: Adjusts the clamp width used in RGB input.

❖ Miscellaneous

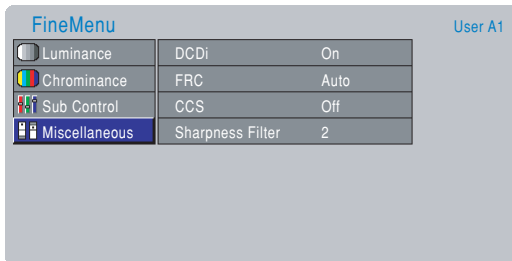

Item	Adjustments
DCDi	On ← → Off
FRC	Auto ← → On
CCS	On ← → Off
Sharpness Filter	0 ← → 4

DCDi

: This menu allows the users to control DCDi.

FRC (Frame Rate Conversion)

Auto : Frame Rate Conversion function is basically off. However FRC turns on automatically depending on vertical frequency of input signal.

ON : Frame Rate Conversion function is "ON". (60Hz fixed)

CCS (Cross Color Suppressor Function)

ON : Cross color suppressor enabled.

OFF : Cross color suppressor disabled. For like progressive scan DVD players, where most of the source material does not contain any cross color, use this mode.

Sharpness Filter

: Adjusts the sharpness of DVI and RGB images.

Setting

The following settings can be made:

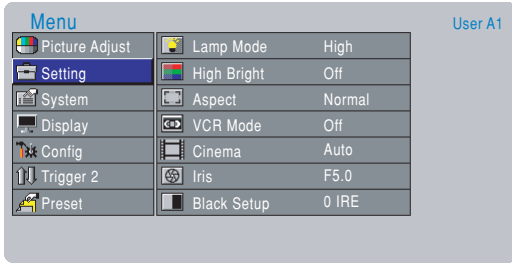

Lamp Mode	High, Low
High Bright	On, Off High Bright On : Display brightest image.
Aspect	Full, Normal, Zoom, Through
VCR Mode	On, Off
Cinema	Auto, Off Cinema mode : The 3-2 pull down for NTSC and the 2-2 pull down for PAL
Iris	F5.0, F3.0 Sets the lens aperture. F5.0: Use to prioritize contrast. F3.0: Use to prioritize brightness.
Black Setup	0IRE, 7.5IRE / NORMAL, EXPAND (For DVI input) Black level adjustment, for adjusting black level by a video source.

VCR Mode

- ON : A projector is forced into the intra-field only deinterlacing mode.
- OFF : A projector is used with external field memories and operates in the full set of deinterlacing modes, i.e., motion adaptive video deinterlacing and full frame film source deinterlacing using 3:2 pulldown detection (2:2 pulldown for 625/50 sources).

❖ Setting the Setting Menu

1. Select the desired menu item and press the ► button.
Setting items appears on the screen.
2. Press the ▲ and ▼ buttons to select a setting.
3. Press the ◀ button to enter the setting and return to menu item selection.

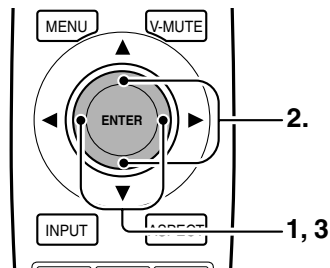
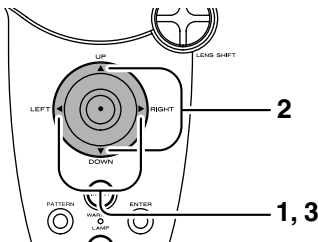

System

The following settings can be made:

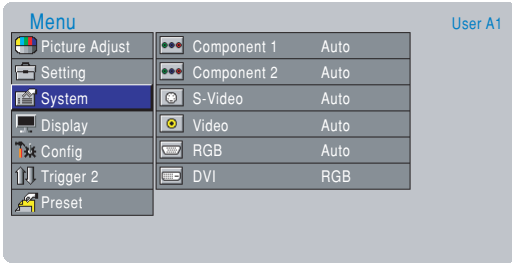

Component1	Auto, NTSC, PAL, 480p, 540p, 576p, 720p, 1035i, 1080i
Component2	Auto, NTSC, PAL, 480p, 540p, 576p, 720p, 1035i, 1080i
S-Video System	Auto, NTSC, PAL, SECAM
Video System	Auto, NTSC, PAL, SECAM
RGB System	Auto, NTSC, PAL, 480p, 540p, 576p, 720p, 1035i, 1080i
DVI System	RGB, YPbPr, YCbCr Color space conversion select for DVI input. RGB: Color Space Conversion is skipped. YPbPr: This mode is suitable for HD TV signal such a 720p, 1080i. YCbCr: This mode is suitable for SD TV signal such a 480i, 480p.

NTSC(NTSC-3.58)	: Conventional analog broadcasting used mainly in USA, Canada, Taiwan, Korea, and Japan.
PAL(PAL-4.43)	: Conventional analog broadcasting used mainly in United Kingdom and Germany.
SECAM	: Conventional analog broadcasting used mainly in France and Russia.
480p	: Standard digital broadcasting
540p	: Special digital broadcasting (for example: RCA DTC100)
576p	: Standard digital broadcasting
720p, 1080i	: High Definition digital broadcasting
1035i	: Japanese "Hi-Vision" broadcasting

❖ Setting the System Menu

1. Select the desired menu item and press the ► button.
Setting items appears on the screen.
2. Press the ▲ and ▼ buttons to select a setting.
3. Press the ◀ button to enter the setting and return to menu item selection.

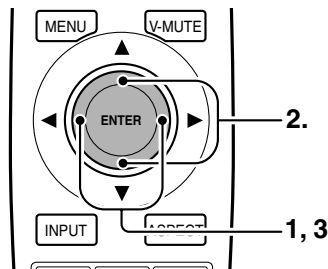
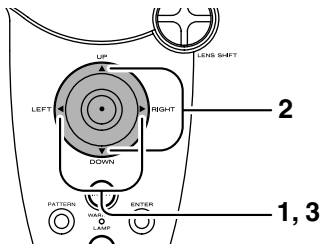

Display

The following adjustments can be made:

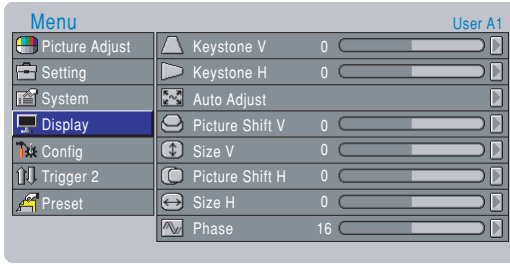

Item	Adjustments
Keystone-V (Electronic vertical keystone correction)	
Keystone-H (Electronic horizontal keystone correction)	
Auto Adjust	Yes / No
Picture Shift V	Down Up
Size V	Small Large
Picture Shift H	Left Right
Size H	Small Large
Phase	Backward Forward

– Keystone H, V

Adjust trapezoid image to rectangle image.

– Auto Adjust

For RGB input, set RGB system on the System menu to “Auto”.

Yes : For RGB IN signal, Picture Shift V and H, Size V and H, and Phase are adjusted automatically.

No : If something wrong with AUTO Adjust, select No, and adjust Size V, Size H, Picture Shift H, Picture Shift V, and/or Phase manually.

Use ◀ / ▶ button to select “Yes”, and press the **ENTER** button.

– Picture Shift V, H

Adjust the position of the picture. H adjusts the horizontal position of the picture. V adjusts the vertical position of the picture.

– Size V, H

Adjust the vertical and horizontal size of the picture.

– Phase

Adjust the phase of the DMD™ dots and the computer signal input from the RGB IN. Adjust the picture to where it looks clearest.

❖ Setting the Display Menu

1. Select the desired menu item and press the ▶ button.
An adjustment bar appears on the screen.
2. Press the ◀ and ▶ buttons to adjust picture quality.
3. Press the ▲ button to enter the adjustment and return to menu item selection.

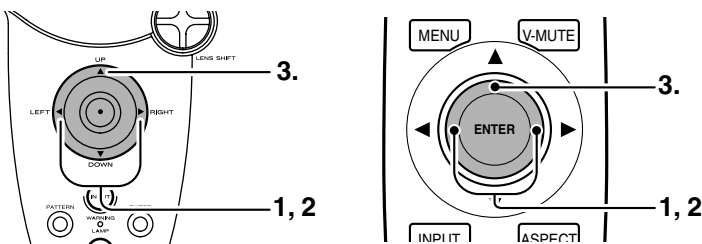

Configuration

The following adjustments can be made:

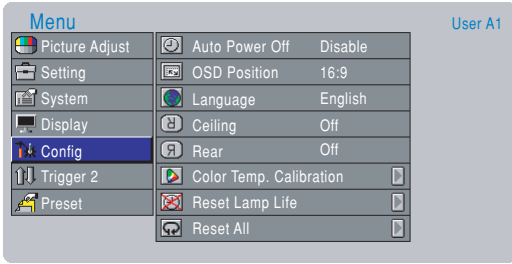

Auto Power Off	Enable, Disable
OSD Position	16:9, 4:3, Through
Language	English, German, French, Spanish, Portuguese, Italian
Ceiling	On, Off On: The picture is reversed horizontally and vertically.
Rear	On, Off On: The picture is reversed horizontally.
Color Temp. Calibration	Yes, No
Reset Lamp Life	Yes, No
Reset All	Yes, No

– Auto Power Off

When the auto power off feature is turned on, power to the projector automatically shuts off if no signals are received and no operations are performed for about 10 consecutive minutes. If 9 minutes pass without the projector receiving any signals or being operated in anyway, the below message appears on the screen.

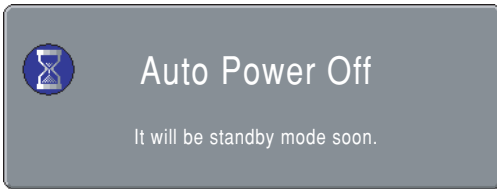

About 1 minute after the message appears on the screen, power to the projector shuts off.

Note:

After the above message appears on the screen, pressing any button on the projector or remote control other than the **POWER** button on the projector and the **POWER ON** or **STANDBY** buttons on the remote control resets the auto power off feature. The auto power off feature will activate again if, after that, the projector goes without receiving any signals or being operated in anyway for 10 consecutive minutes.

– OSD Position (16:9 / 4:3)

OSD position is selected from 16:9, 4:3 and Through.



16 : 9 OSD position

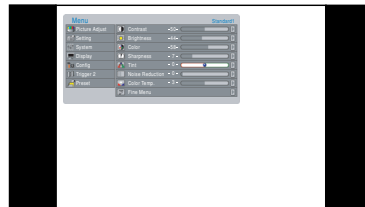

4 : 3 OSD position

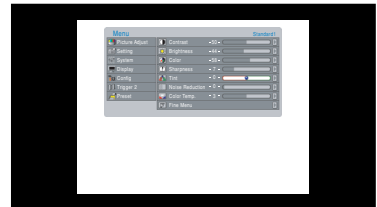

Through OSD position

– Color Temp. Calibration

After replacing the lamp or in other cases where the lighting changes, color temperature can be adjusted using the included color temperature sensor. For more information on how to adjust color temperature, see “Color Temperature Adjustment” (P.36).

– Reset Lamp Life

If the lamp is replaced before reaching its 2000 hours lamp life, be sure to reset the lamp's life counter. To do this, select “Reset Lamp Life” from the Configuration menu. When you do so, the below message appears on the screen.



Again, select “Yes”, and press the **ENTER** button. Then the lamp life is initialized.

– Reset All

All settings are reset to the factory default settings except the lamp life. When the user selects “Yes”, the following message appears:

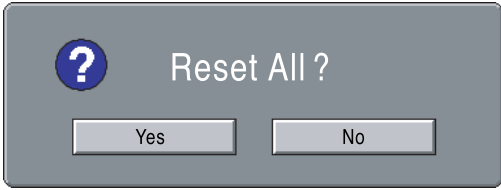

Again, select “Yes”, and press the **ENTER** button.

❖ Setting the Config Menu

1. Select the desired menu item and press the ► button. Setting items appears on the screen.
2. Press the ▲ and ▼ buttons to select a setting.
3. Press the ◀ button to enter the setting and return to menu item selection.

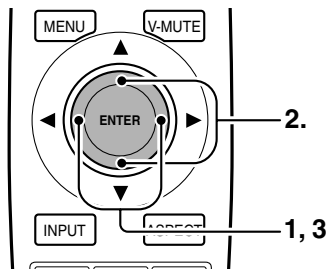
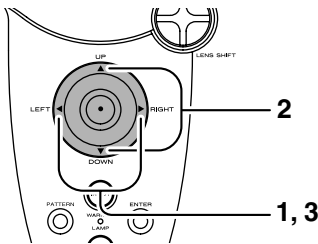

Trigger 2

Select either 12V output or 0V output by choosing On or Off for each aspect mode. Full, Normal, Zoom, and Through. This allows you to control such as a powered dual aspect screen with the outputs for the aspect modes.

- On: Output DC 12V.**
- Off: No output.**

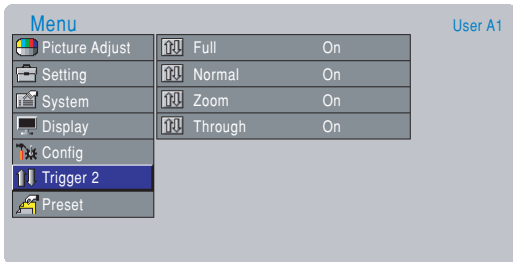

❖ Setting the Trigger 2 Menu

1. Select the desired menu item and press the ► button. Setting items appears on the screen.
2. Press the ▲ and ▼ buttons to select a setting.
3. Press the ◀ button to enter the setting and return to menu item selection.

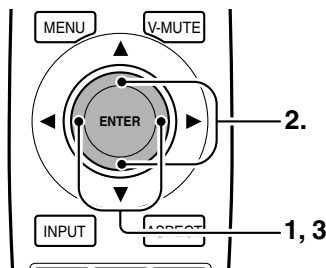
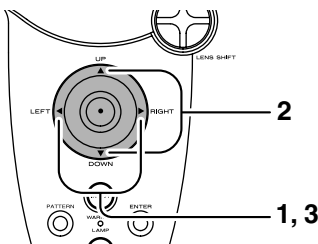

Preset

The picture mode can also be selected from the MENU screen. This projector offers 6 picture modes: Theater, Standard, Dynamic, User A, User B and User C. Moreover, each of these picture modes has 3 indexes for memorizing picture quality adjustments.

- **Theater** : Reproduces the black suited for movie software.
- **Standard** : Suited for normal movie software.
- **Dynamic** : Suited for visually dynamic image software.
- **User A,B,C**: Enable the user to adjust the gamma curve as preferred.

Note : Each picture mode has 3 indexes (1, 2 and 3) and a default setting. When default is selected, "Picture Adjust" cannot be selected from the menu.

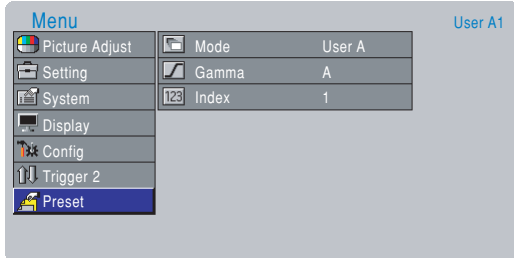

– Memorizing settings in an index

Select "Mode" from the above menu with the remote control, then select an image mode from Theater, Standard, Dynamic, and User A, B or C. Next, select the "Index" from the menu and set one value from "1" to "3". Return to "Picture Adjust" in the main menu and adjust picture quality to your liking. The adjustment made here is automatically saved in memory.

– Gamma setting

Select "Mode" from the above menu with the remote control, then select User A, B or C as the picture mode. When you do so, a gamma menu appears on the MENU screen. Select "Gamma" and the desired gamma curve (A, B, C, D, E, a, b, c).

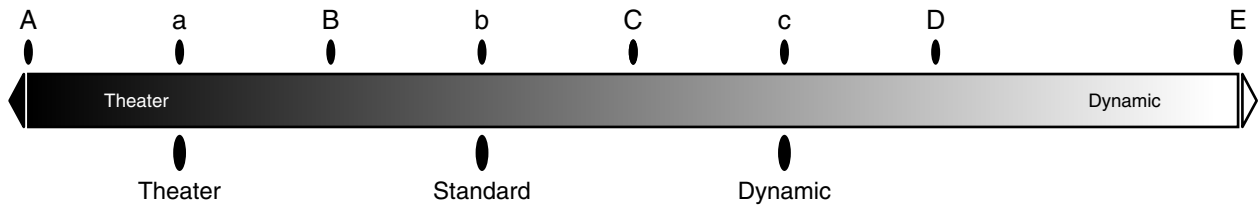

You can also create your own gamma curve using special software. The created gamma curve can be stored in memory banks a, b or c. A memory bank that contains a stored gamma curve is indicated with an * mark in the MENU screen. When the projector is shipped from the factory, Theater is stored in memory bank a, Standard in memory bank b and Dynamic in memory bank c. (See above figure.)

❖ Setting the Preset Menu

1. Select the desired menu item and press the ► button.
Setting items appears on the screen.
2. Press the ▲ and ▼ buttons to select a setting.
3. Press the ◀ button to enter the setting and return to menu item selection.

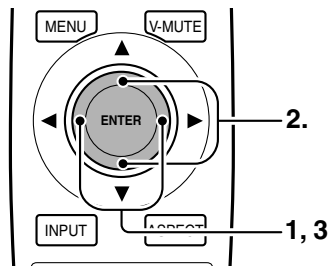
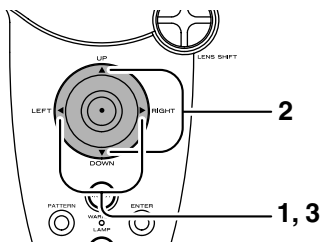

Lamp Life and Replace Lamp

❖ Lamp Life

Display the remaining lamp life by pressing the **INFO.** button on the remote controller.

i Information	
Video Input	Component-1080i
Preset	User A1
Gamma	A
Cinema Mode	Auto
Aspect	Normal
Trigger 2	On
Lamp Life	921 Hours
Total Hours	3653 Hours

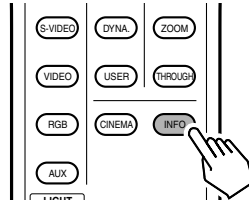

Notes:

- The maximum life limit of the lamp is 2,000 hours. Although we care very much about quality, the lamp can rarely break down if running time exceeds 1,000 hours. Therefore we recommend to replace the lamp if Lamp Life gets under 1,000 hours. The lamp cannot be used exceeding the maximum life limit.
 - This product is checked under strict quality control when it is shipped out from factory.
 “Total Hours” in the menu includes the time for this check. So “Total Hours” may not be 0 hours when it is used first time.
- When the lamp life becomes less than 100 hours and the unit is still on, the remaining lamp life is displayed on the screen automatically.

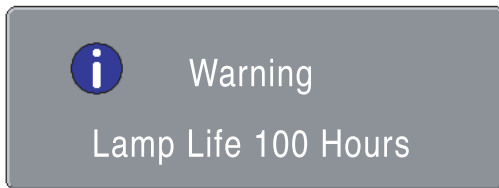

- When the lamp life becomes less than 5 hours, the remaining lamp life is displayed on the screen .

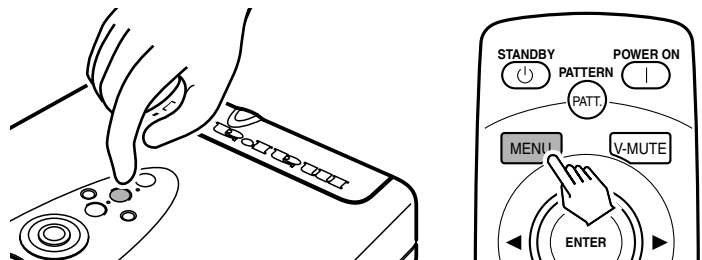
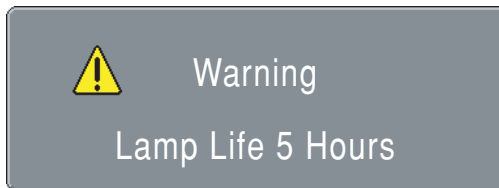

To clear the warning, press the **MENU** button.

- Approximately 2 minutes after the lamp reaches the end of its lamp life, power to the projector shuts OFF and the WARNING indicator lights up a red color. If the below message appears on the screen and power shuts OFF soon thereafter, promptly replace the lamp with a new one. (See “Replacing Lamp Unit” P.34)



❖ Initialize the Lamp Life

The lamp has a lamp life of 2000 hours. The projector is designed to shut OFF power if the lamp is used beyond this 2000 hours lamp life. In such case, replace the lamp and reset the lamp life counter as follows.

1. After the message “Lamp Life 0 Hours” appears, power to the projector shuts OFF. Promptly replace the lamp with a new one. (P.34 “Replacing Lamp Unit”)
2. Once the lamp has been replaced, press the **POWER ON** button on the remote control or the **POWER** button on the projector.

The below message appears on the screen for 120 seconds.



3. Select “Yes”, using the ◀/▶ buttons.
4. Press the **ENTER** button. The lamp life indicator is now initialized.

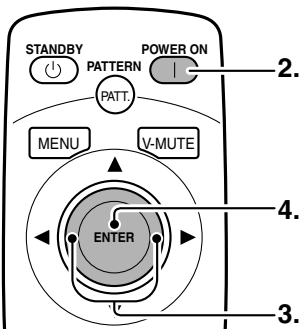
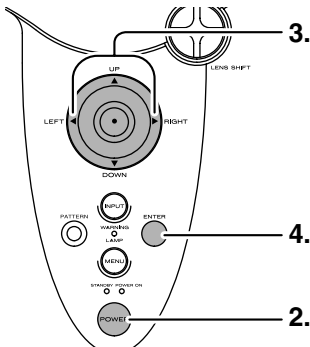

Replacing Lamp Unit

CAUTION:

- Do not touch the lamp and the lamp unit carelessly. It is extremely hot. Wait at least one hour for the lamp to cool down before handling.
- Do not loosen any screws except for those mentioned below.
- The lamp may break if handled improperly.
- Do not use other than a Marantz replacement lamp unit.

❖ How to replace the Lamp Unit

PREPARATION:

When replacing the lamp, turn off the power for the projector. After the cooling fan stops, disconnect the power cord and wait for one hour until the lamp is cooled down completely, then replace the lamp.

1. Press the **STANDBY** button on the remote controller or the **POWER** button on the projector to turn the projector off.

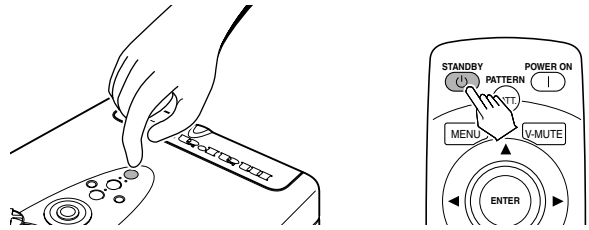

2. After the cooling fan stops, Unplug the AC power cord.

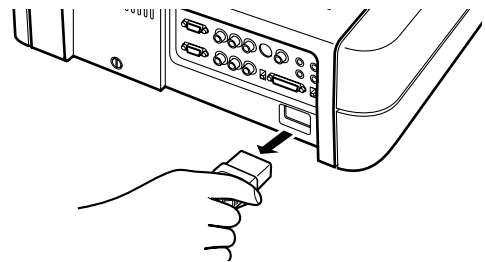

3. Wait at the least one hour for the lamp and lamp unit to cool down.
4. Read the caution and warning labels on the unit.

Lamp cover

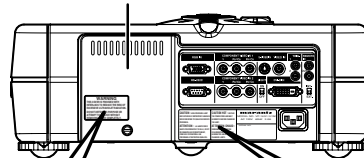

WARNING
THIS COVER IS PROVIDED WITH INTERLOCK TO REDUCE THE RISK OF EXCESSIVE ULTRAVIOLET RADIATION. DO NOT DEFEAT ITS PURPOSE OR ATTEMPT TO SERVICE WITHOUT REMOVING COVER COMPLETELY.

CAUTION : HIGH PRESSURE LAMP MAY EXPLODED IF IMPROPERLY HANDLED. REFER SERVICING TO QUALIFIED SERVICE PERSONNEL.

ATTENTION : LA LAMPE SOUS HAUTE PRESSION PEUT SI ELLE, N'EST PAS MANIPULEE CORRECTEMENT, CONFIER L'OPERATION A UN PERSONNEL D'ENTRETIEN QUALIFIE.

CAUTION HOT : UNPLUG THE POWER CORD AND WAIT 60 MINUTES BEFORE CHARGING THE LAMP.

ATTENTION CHAUD : DEBRANCHER LE CORD ON D'ALIMENTATION ET ATTENDRE 60 MINUTES AVANT DE CHANGER LAMPE.

5. Remove the lamp cover screw.

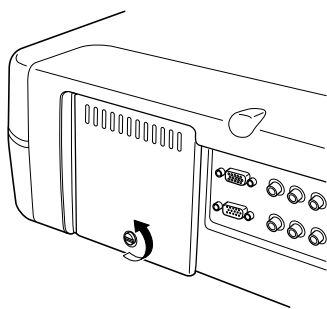

6. Remove the lamp cover in the direction of the arrow.

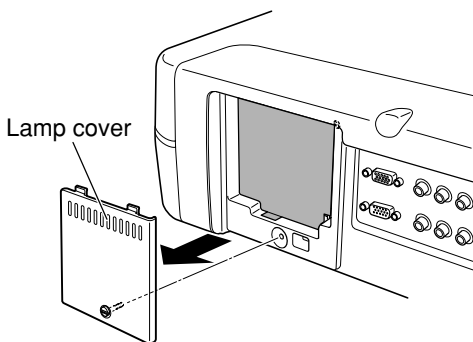

7. Open the cover sheet and remove the two screws (slotted head screwdriver required) that lock down the lamp unit. Do not remove any other screws.

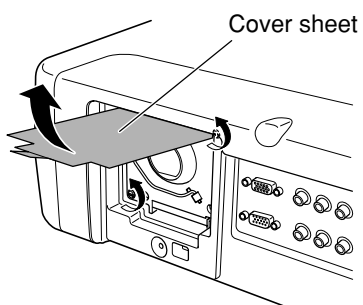

8. Holding the handle and pull the lamp unit out toward your side.

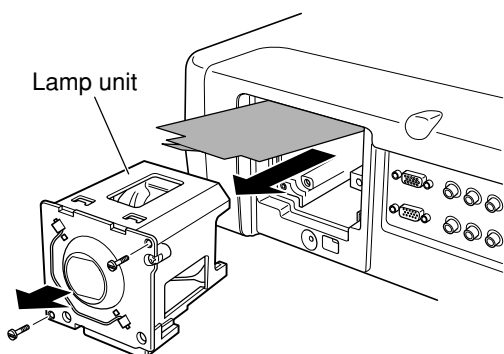

9. Install a new lamp unit in position securely.

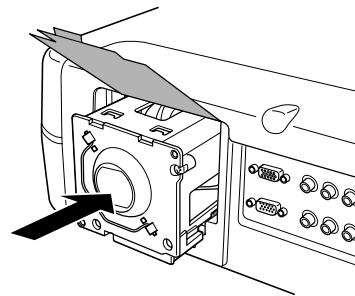

10. Lock the lamp unit in place with the two screws removed in step 7. Press on the handle until it folds over and close the cover sheet.

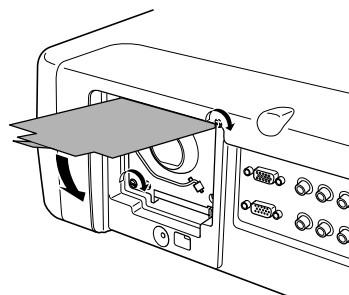

11. Install the lamp cover back in its original position and fasten with the fastening screw.

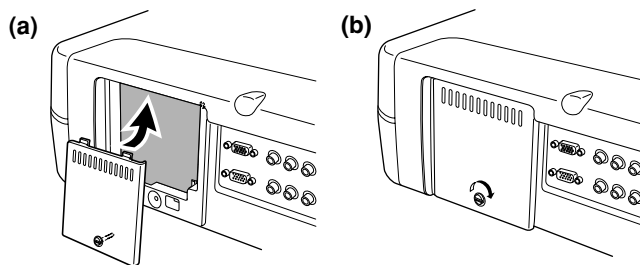

12. Plug in the video projector and turn on the power and project the image.

- If the lamp is replaced before reaching its 2000 hours lamp life, see "Reset Lamp Life" (P.30).
- If the lamp is replaced after reaching its 2000 hours lamp life, see "Initialize the Lamp Life" (P.34).

Color Temperature Adjustment

After replacing the lamp or in other cases where the lighting changes, color temperature can be adjusted using the included color temperature sensor. In the adjustment procedure, you must first initialize the sensor itself before adjusting color temperature. It takes about 10 minutes from when the power to the projector is activated for the lamp's brightness to stabilize. Wait for lamp brightness to stabilize before adjusting color temperature.

1. Connect the cable of the color temperature sensor to the RS-232C port.

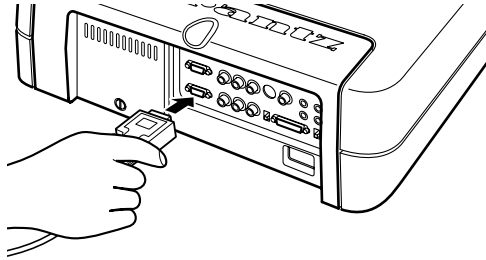

2. Press the **MENU** button and select "Color Temp. Calibration" from the MENU screen. Press the **▶** button. The below message appears on the screen.

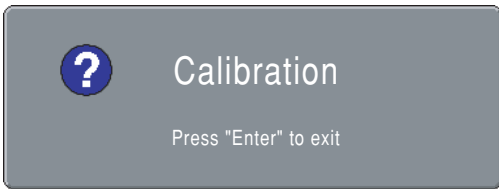

3. Use the **◀** and **▶** buttons to select "Yes" and press the **ENTER** button. The below message appears on the screen.

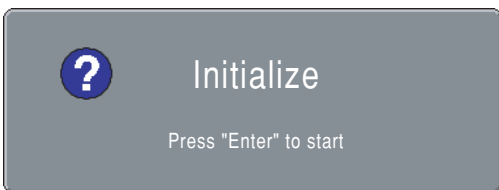

Before pressing the **ENTER** button, turn the color temperature sensor over on its dark side as shown in the below figure, to prevent outside light from penetrating to the sensor's condenser.

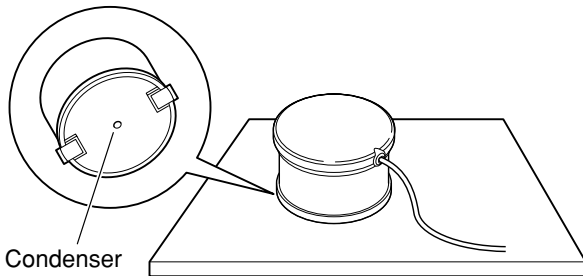

4. Press the **ENTER** button. The below message appears on the screen for a few seconds as the sensor is being calibrated.



5. Turn the lens shift knob until bringing the position of the projected image (lens shift position) to the center of the screen.

Note:

Unless the lens shift position is brought to the center of the screen, color temperature cannot be correctly adjusted.

As a yardstick for centering the lens shift position, the lens shift knob can turn 11 times from one end of the lens shift range to the other. Therefore, turn the knob completely to one end and then return it about 5 1/2 turns.

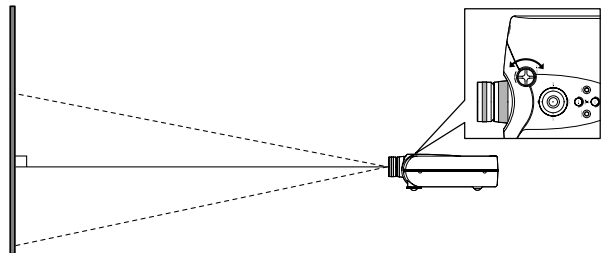

6. Fit the color temperature sensor onto the lens and press the **ENTER** button. Color temperature adjustment starts and the projector's **WARNING** and **STANDBY** indicators begin flashing simultaneously.

When installed on a tabletop

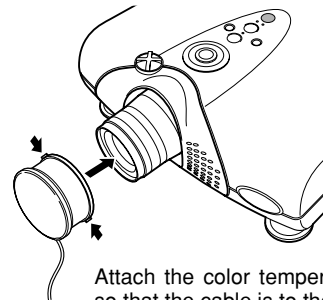

Attach the color temperature sensor so that the cable is to the bottom side of the projector.

When installed on a ceiling

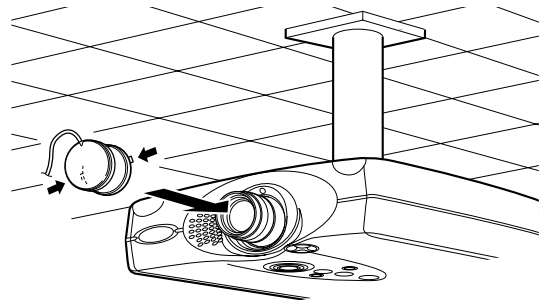

Attach the color temperature sensor so that the cable is to the bottom side of the projector.

7. When the **WARNING** and **STANDBY** indicators go out, color temperature adjustment is complete. Adjustment takes about 4 to 5 minutes. When the color temperature sensor is detached from the lens, the below message appears on the screen.

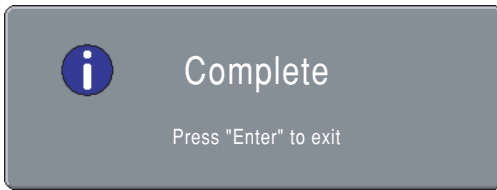

8. Press the **ENTER** button to return to the menu and disconnect the cable of the color temperature sensor from the projector.

Note:

If color temperature adjustment is not correctly processed or if adjustment processing is interrupted in course by pressing the **MENU** button or for some other reason, the below message appears on the screen.



Also, adjustment processing can be interrupted by pressing the **MENU** button.

❖ Color Temperature Sensor Protection

If no operations are performed for approximately 10 minutes from the moment color temperature adjustment processing ends, power to the projector shuts OFF automatically in order to protect the color temperature sensor. If power is shut OFF to protect the color temperature sensor, do the following.

• **If the **WARNING** indicator does not light**

When color temperature adjustment ends successfully and the sensor protection feature trips, the projector goes on standby. As usual, activate power by pressing either the **POWER ON** button on the remote control or the **POWER** button on the projector.

• **If the **WARNING** indicator lights**

If color temperature adjustment does not end successfully and the sensor protection feature trips, the projector's **WARNING** and **STANDBY** indicators light simultaneously to indicate the error mode. Unplug the power cable and then plug it back in. Then, press either the **POWER ON** button on the remote control or the **POWER** button on the projector to reactivate power.

Cleaning the Lens

If the lens becomes dirty or smudged, clean it with a soft dry cloth only. Use optical lens cleaners that are approved for eyeglasses or cameras. Do not use a dampen cloth, detergent solution, or thinner. It may damage the lens and remain as stains.

Replacement Parts

When replacement parts are required, be sure to inform a Marantz authorized service center. Use only replacement parts specified by Marantz. Unauthorized substitutions may result in fire, electric shock, or other hazards. And, the warranty may not be guaranteed.

Optional Accessories

- **Lamp Unit** : **LU-12VPS3**

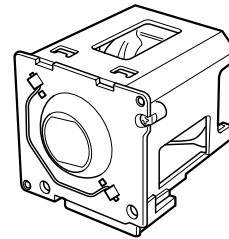

- **Ceiling Mount kit** : **MOUNT 12**
This kit is specially designed to mount the unit on ceiling.

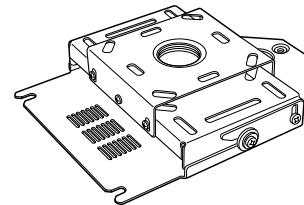

- **Extension Pole** : **EXT-81**
This tool is to adjust height with the Ceiling Mount Kit MOUNT 12.

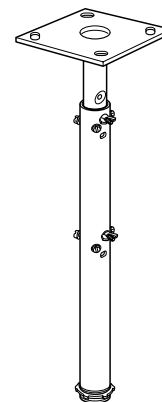

CAUTION:

For ceiling installation, consult with the Marantz Authorized dealer.

TROUBLESHOOTING

Try the following troubleshooting before calling for service.

1. Are the connections made properly ?
2. Are you operating the unit properly, following the instructions ?

If the unit does not operate properly, check the items shown in the following table.

If any trouble cannot be solved by the instructions below, malfunction of the internal circuitry is suspected; immediately unplug the AC power cord and contact Marantz dealer or service center.

Symptom	Possible Cause	Remedy
No power	AC power cord is not connected correctly.	Connect the AC power cord properly.
	Lamp cover is not closed correctly.	Close the cover properly.
Image is not displayed.	A signal cable is not connected correctly.	Connect a signal cable properly.
	Selected input is incorrect.	Select the correct input source .
	The picture mute is active.	Press the MUTE button to release the mute.
Poor color.	Picture is not adjusted properly.	Adjust the picture in the MENU mode.
Picture is too dark.	Lamp life is running out.	Replace the lamp.
	Contrast or brightness is not adjusted properly.	Adjust contrast or brightness properly.
Picture is not clear.	Picture is out of focus.	Adjust the focus.
	Dew is on the lens.	Run the projector for about two hours.
Picture rolls.	A signal cable is not properly connected.	Connect a signal cable properly.
The Remote Controller does not work.	Batteries are exhausted.	Replace batteries.
	The distance to the unit is too far.	Make the distance between the unit and the remote control closer.
	IR sensor on unit is obstructed.	Remove any obstacles.
	The "EXTERNAL" position on the connector panel is selected.	Select the "INTERNAL" position.
Color temperature cannot be adjusted.	Is the sensor cable disconnected?	Correctly connect the sensor cable.
	Was the sensor correctly initialized?	Initialize the sensor by taking the correct procedures.
	Is the lens shift knob set to the correct (center) position?	Set the lens shift knob to the correct (center) position by taking the correct procedures.

Note:

- If the lamp still does not function after the replacement and initialization of the lamp life, contact a Marantz authorized dealer, or service center.

Note: This projector uses a microcomputer. External noise can cause malfunctions. In such case, shut power OFF and unplug the power cable from AC power outlet. Then, plug the AC power cable back in, press the **POWER** button on the projector or the **POWER ON** button on the remote control and check operation.

ERROR MODE

WARNING/LAMP indicator, POWER ON indicator, and STANDBY indicator diagnose error mode of the projector as follows.

Error mode	Indicators			Possible Cause	Recommendation
	WARNING /LAMP	POWER ON	STANDBY		
Lamp cover	ON	OFF	Flashing	The lamp cover is not closed properly.	Close the cover correctly.
Lamp	ON	OFF	OFF	The lamp has failed, or the lamp is completely worn out.	Replace the lamp and reset lamp life.
Temperature	Flashing	OFF	Flashing	Projector internal temperature is higher than the allowed level.	Check if anything is blocking the exhaust vent.
Fan	Flashing	OFF	ON	Trouble has occurred with the fan.	
Color temperature adjustment	ON	OFF	ON	Color temperature adjustment failed.	Retry adjustment.
Other	Flashing	OFF	OFF	Internal program error	Shut power OFF and ON again.

ON SCREEN MESSAGE

Use the list below to check the message displayed on the screen.

Message	Meaning	Remedy
NO SIGNAL	No input signal.	Properly connect the cables.
REPLACE LAMP!	The lamp has reached the end of its life.	Replace the lamp and reset lamp life.
OUT OF RANGE	Improper signal feed to the projector.	Adjust resolution, V(Hz) : refresh rate of the equipment, referring to the Timing Chart.

SPECIFICATIONS

❖ Optical characteristics

Panel	0.8 inch 16:9 1280 x 720 pixels Digital Micromirror Device™
Lamp	Super High Pressure 200W DC
Lens	f: 26.5 to 30.7mm (VP-12S3) 40.9 to 55.3mm (VP-12S3L) F: F3.0/F5.0
Projection size	40 to 250 inches
Light output	600/700 ANSI LUMEN typical (F5.0/F3.0)

❖ Input/Output

VIDEO IN	RCA x 1 NTSC-3.58/PAL-4.43/SECAM Composite video 1.0Vp-p/75 Ohm
S-VIDEO IN	S-Connector x 1 NTSC-3.58/PAL-4.43/SECAM S-Video
COMPONENT IN	RCA x 2 Y, CB/PB, CR/PR
RGB/HD IN	D-sub M 15 pin x 1 Analog RGB HD:1080i, 720p, 480p
DVI-D IN	DVI-D 24pin x 1 T.M.D.S compliant (single link only)
REMOTE CONTROLLER IN	Mini jack type x 1
REMOTE CONTROLLER OUT	Mini jack type x 1
AC IN	3 Prong Grounding Type
TRIG.1 OUT, TRIG.2 OUT	Mini Jack x 2 Output: DC12V or 0V
RS232C	RS232C receptacle plug x 1

❖ General

Power requirement	AC 100-120V / 220-240V, 50/60 Hz
Power consumption	< 320 W
Standby consumption	< 3.3 W
Chassis isolation	Class-1
Safety	UL6500 CSA E60065 EN60950
EMC	FCC Part-15 Class-B EN55022 Class-B
Dimensions	15 15/16(W) x 18 9/16(D) x 6 1/8(H) inch 404.5(W) x 471(D) x 158(H) mm
Net weight	13 kg
Operating Temperature	5 to 35 °C
Operating humidity	30 to 85%
Storage Temperature	- 20 to 60 °C
Storage humidity	30 to 85%

❖ Accessories

- Lens cap x 1
- Remote controller x 1
- Batteries x 2
- AC power code (only for 125V) x 1
- Color temperature sensor x 1
- User Guide x 1
- Control Adapter cable (Mini jack to RCA) x 1
- Warranty Card (1 copy each for USA, CANADA)

Specifications may be subjected to change without any prior notice.

❖ Timing chart

Input Signal

System	Resolution	V (Hz)	H (KHz)	Scan
NTSC	768x240	59.94 / 60	15.73	I
PAL-B/G	960x287.5	50	15.63	I
SECAM	960x287.5	50	15.63	I
480/60p	720x480	59.94 / 60	31.5	P
576/50p	720x576	50	31.3	P
1035/60i	1920x518	59.94 / 60	33.8	I
1080/60i	1920x540	59.94 / 60	33.8	I
1080/50i	1920x540	50	28.1	I
1080/48i	1920x540	48	27.0	I
720/60p	1280x720	59.94 / 60	45.0	P
720/50p	1280x720	50	37.5	P
720/48p	1280x720	48	36.0	P
540/60p	1920x540	59.94 / 60	33.8	P
640x350 ^{#1}	640x350	70	31.5	P
640x350 ^{#1}	640x350	85	37.9	P
640x400 ^{#1}	640x400	70	31.5	P
640x400 ^{#1}	640x400	85	53.7	P
640x480	640x480	60	31.5	P
640x480 ^{#1}	640x480	72	37.9	P
640x480 ^{#1}	640x480	75	37.5	P
640x480 ^{#1}	640x480	85	43.3	P
800x600	800x600	56	35.2	P
800x600	800x600	60	37.9	P
800x600 ^{#1}	800x600	72	48.1	P
800x600 ^{#1}	800x600	75	46.9	P
800x600 ^{#1}	800x600	85	53.7	P
1024x768	1024x768	43	35.5	P
1024x768	1024x768	60	48.4	P
1024x768 ^{#1}	1024x768	70	56.5	P
1024x768 ^{#1}	1024x768	75	60.0	P
1024x768 ^{#1}	1024x768	85	68.7	P

Signal	Video	S-Video	Component	RGB	DVI	Note
NTSC	X	X	—	—	—	
PAL-B/G	X	X	—	—	—	
SECAM	X	X	—	—	—	
Video 60Hz	—	—	X	X	—	#2
Video 50Hz	—	—	X	X	—	
480/60p	—	—	X	X	X	#2
576/50p	—	—	X	X	X	
1035/60i	—	—	X	X	X	#2
1080/60i	—	—	X	X	X	#2
1080/50i	—	—	X	X	X	
1080/48i	—	—	X	X	X	
720/60p	—	—	X	X	X	#2
720/50p	—	—	X	X	X	
720/48p	—	—	X	X	X	
540/60p	—	—	X	X	X	#2
640x350@70Hz	—	—	—	X	X	
640x350@85Hz	—	—	—	X	X	
640x400@70Hz	—	—	—	X	—	
640x480@60Hz	—	—	—	X	X	
640x480@72Hz	—	—	—	X	—	VESA#901101
640x480@75Hz	—	—	—	X	—	
640x480@85Hz	—	—	—	X	—	
800x600@56Hz	—	—	—	X	X	VESA#900601
800x600@60Hz	—	—	—	X	X	VESA#900602
800x600@72Hz	—	—	—	X	—	VESA#900603A
800x600@75Hz	—	—	—	X	—	
800x600@85Hz	—	—	—	X	—	
1024x768@60Hz	—	—	—	X	X	
1024x768@70Hz	—	—	—	X	—	
1024x768@75Hz	—	—	—	X	—	

#2 : both of 59.94 and 60Hz

I : Interlaced signal
P : Progressive signal

Notes:

- The systems marked #1 are not displayed properly.
- Any signals not in the list above may not be projected properly.

DIMENSIONS

❖ Top

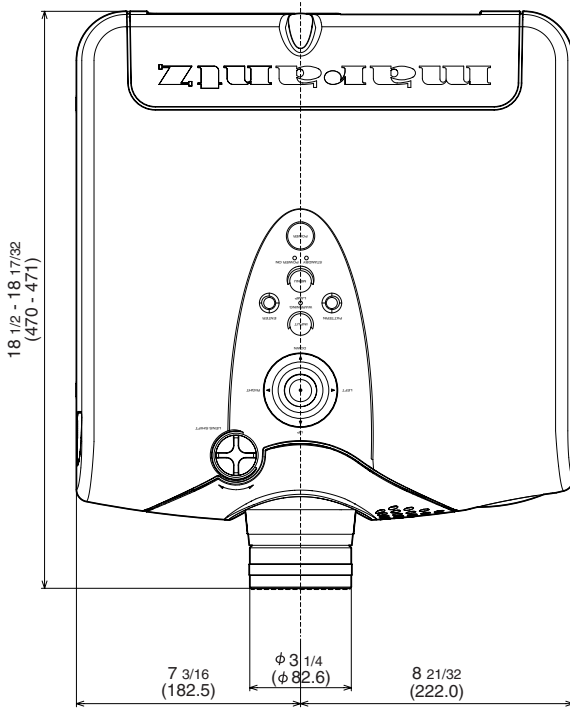

❖ Front

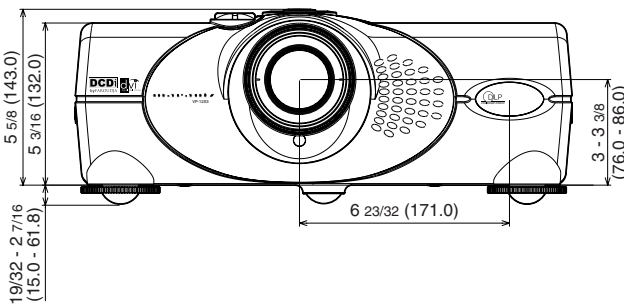

❖ Rear

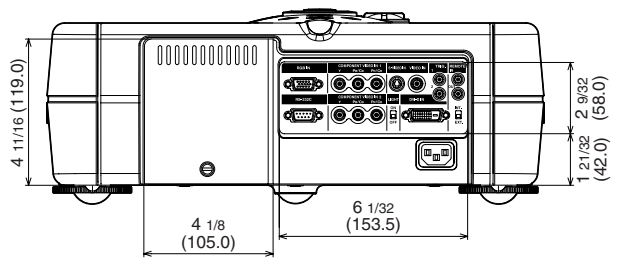

❖ Bottom

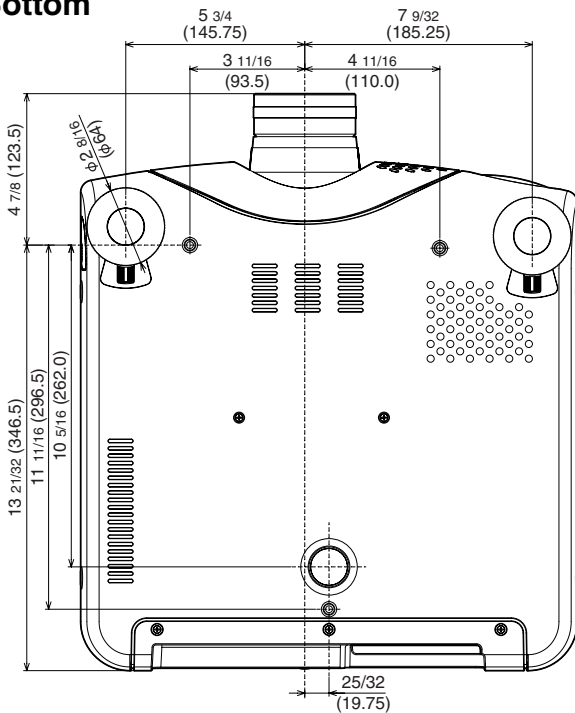

Unit : inch (mm)

GLOSSARY

Aspect ratio

Width and height ratio of an image. The normal aspect ratio of a computer and video image is 4 : 3. There are also wide images with an aspect ratio of 16 : 9 and 21 : 9.

Black Level (Black setup)

The signal level which represents black picture intensity.

For NTSC system for USA, this level is 7.5IRE.

For NTSC system for Japan and DVD, this level is 0IRE.

NORMAL: 16 (Black) ~ 235 (White)

EXPAND: 0 (Black) ~ 246 (White)

Color Temperature

White color hue.

Low color temperature implies a warmer (more yellow/red) light.

High color temperature implies a colder (more blue) light.

Keystone

Distortion of the image caused by projection to a wrong vertical/horizontal angle.

www.marantz.com

You can find your nearest authorized distributor or dealer on our website.

JAPAN	Marantz Japan, Inc.	35-1 Sagami Ohno 7-Chome, Sagamihara-shi, Kanagawa 228-8505, Japan
U.S.A.	Marantz America, Inc.	1100 Maplewood Drive, Itasca, IL 60143, U.S.A.
EUROPE	Marantz Europe B.V.	P.O. Box 8744, 5605 LS Eindhoven, The Netherlands

marantz[®] is a registered trademark.

