

marantz®

Model SC-11S1 User Guide

Stereo Control Amplifier

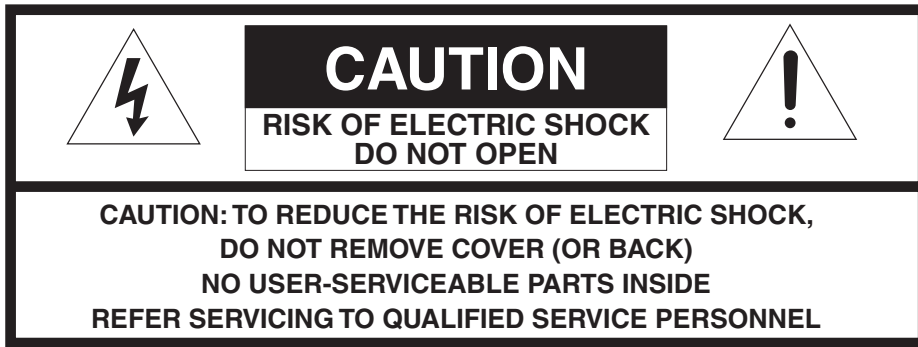

The lightning flash with arrowhead symbol within an equilateral triangle is intended to alert the user to the presence of uninsulated “dangerous voltage” within the product’s enclosure that may be of sufficient magnitude to constitute a risk of electric shock to persons.



The exclamation point within an equilateral triangle is intended to alert the user to the presence of important operating and maintenance (servicing) instructions in the literature accompanying the product.

WARNING

TO REDUCE THE RISK OF FIRE OR ELECTRIC SHOCK, DO NOT EXPOSE THIS APPLIANCE TO RAIN OR MOISTURE.

CAUTION: TO PREVENT ELECTRIC SHOCK, MATCH WIDE BLADE OF PLUG TO WIDE SLOT, FULLY INSERT.

ATTENTION: POUR EVITER LES CHOCS ELECTRIQUES, INTRODUIRE LA LAME LA PLUS LARGE DE LA FICHE DANS LA BORNE CORRESPONDANTE DE LA PRISE ET POUSSER JUSQU'AU FOND.

IMPORTANT SAFETY INSTRUCTIONS

READ BEFORE OPERATING EQUIPMENT

This product was designed and manufactured to meet strict quality and safety standards. There are, however, some installation and operation precautions which you should be particularly aware of.

1. Read these instructions.
2. Keep these instructions.
3. Heed all warnings.
4. Follow all instructions.
5. Do not use this apparatus near water.
6. Clean only with dry cloth.
7. Do not block any ventilation openings. Install in accordance with the manufacture's instructions.
8. Do not install near any heat sources such as radiators, heat registers, stoves, or other apparatus (including amplifiers) that produce heat.
9. Do not defeat the safety purpose of the polarized or grounding-type plug. A polarized plug has two blades with one wider than the other. A grounding type plug has two blades and a third grounding prong. The wide blade or the third prong are provided for your safety. If the provided plug does not fit into your outlet, consult an electrician for replacement of the obsolete outlet.



10. Protect the power cord from being walked on or pinched particularly at plugs, convenience receptacles, and the point where they exit from the apparatus.
11. Only use attachments/accessories specified by the manufacturer.
12. Use only with the cart, stand, tripod, bracket, or table specified by the manufacturer, or sold with the apparatus. When a cart is used, use caution when moving the cart/apparatus combination to avoid injury from tip-over.
13. Unplug this apparatus during lightning storms or when unused for long periods of time.
14. Refer all servicing to qualified service personnel. Servicing is required when the apparatus has been damaged in any way, such as power-supply cord or plug is damaged, liquid has been spilled or objects have fallen into the apparatus, the apparatus has been exposed to rain or moisture, does not operate normally, or has been dropped.

Additional Safety Information!

- This product should not be placed in a built-in installation such as a bookcase or rack unless proper ventilation is provided or the manufacturer's instructions have been adhered to.
- Apparatus shall not be exposed to dripping or splashing and that no objects filled with liquids, such as vases, shall be placed on the apparatus.
- When the switch is in the OFF position, the apparatus isn't completely switched-off from the MAINS.
- The equipment shall be installed near the Socket-Outlet and shall be easily accessible.

Do not touch hot spots during and immediately after use.

During and immediately after use, this product is hot in areas other than the controls and rear panel connection jacks. Do not touch hot spots and especially the top panel. Contact with hot areas can cause burns.

Do not expose the unit to excessive heat such as direct sunlight, fire or the like.

ENGLISH

WARRANTY

For warranty information, contact your local Marantz distributor.

RETAIN YOUR PURCHASE RECEIPT

Your purchase receipt is your permanent record of a valuable purchase. It should be kept in a safe place to be referred to as necessary for insurance purposes or when corresponding with Marantz.

IMPORTANT

When seeking warranty service, it is the responsibility of the consumer to establish proof and date of purchase. Your purchase receipt or invoice is adequate for such proof.

FOR U.K. ONLY

This undertaking is in addition to a consumer's statutory rights and does not affect those rights in any way.

FRANÇAIS

GARANTIE

Pour des informations sur la garantie, contacter le distributeur local Marantz.

CONSERVER L'ATTESTATION D'ACHAT

L'attestation d'achat est la preuve permanente d'un achat de valeur. La conserver en lieu sûr pour s'y reporter aux fins d'obtention d'une couverture d'assurance ou dans le cadre de correspondances avec Marantz.

IMPORTANT

Pour l'obtention d'un service couvert par la garantie, il incombe au client d'établir la preuve de l'achat et d'en corroborer la date. Le reçu ou la facture constituent des preuves suffisantes.

DEUTSCH

GARANTIE

Bei Garantiefragen wenden Sie sich bitte an Ihren Marantz-Händler.

HEBEN SIE IHRE QUITTING GUT AUF

Die Quittung dient Ihnen als bleibende Unterlage für Ihren wertvollen Einkauf. Das Aufbewahren der Quittung ist wichtig, da die darin enthaltenen Angaben für Versicherungszwecke oder bei Korrespondenz mit Marantz angeführt werden müssen.

WICHTIG!

Bei Garantiefragen muß der Kunde eine Kaufunterlage mit Kaufdatum vorlegen. Ihren Quittung oder Rechnung ist als Unterlage ausreichend.

NEDERLANDS

GARANTIE

Voor inlichtingen omtrent garantie dient u zich tot uw plaatselijke Marantz.

UW KWITANTIE, KASSABON E.D. BEWAREN

Uw kwitantie, kassabon e.d. vormen uw bewijs van aankoop van een waardevol artikel en dienen op een veilige plaats bewaard te worden voor evt. verwijzing bijv. in verband met verzekering of bij correspondentie met Marantz.

BELANGRIJK

Bij een evt. beroep op de garantie is het de verantwoordelijkheid van de consument een gedateerd bewijs van aankoop te tonen. Uw kassabon of factuur zijn voldoende bewijs.

ITALIANO

GARANZIA

L'apparecchio è coperto da una garanzia di buon funzionamento della durata di un anno, o del periodo previsto dalla legge, a partire dalla data di acquisto comprovata da un documento attestante il nominativo del Rivenditore e la data di vendita. La garanzia sarà prestata con la sostituzione o la riparazione gratuita delle parti difettose.

Non sono coperti da garanzia difetti derivanti da uso improprio, errata installazione, manutenzione effettuata da personale non autorizzato o, comunque, da circostanze che non possano riferirsi a difetti di funzionamento dell'apparecchio. Sono inoltre esclusi dalla garanzia gli interventi inerenti l'installazione e l'allacciamento agli impianti di alimentazione.

Gli apparecchi verranno riparati presso i nostri Centri di Assistenza Autorizzati. Le spese ed i rischi di trasporto sono a carico del cliente.

La casa costruttrice declina ogni responsabilità per danni diretti o indiretti provocati dalla inosservanza delle prescrizioni di installazione, uso e manutenzione dettagliate nel presente manuale o per guasti dovuti ad uso continuato a fini professionali.

CE MARKING

CE English

The SC-11S1 is in conformity with the EMC directive and low-voltage directive.

CE Français

Le SC-11S1 est conforme à la directive EMC et à la directive sur les basses tensions.

CE Deutsch

Das Modell SC-11S1 entspricht den EMC-Richtlinien und den Richtlinien für Niederspannungsgeräte.

CE Nederlands

De SC-11S1 voldoet aan de EMC eisen en de vereisten voor laag-voltage.

CE Italiano

Il SC-11S1 è conforme alle direttive CEE ed a quelle per i bassi voltaggi.

English

WARNINGS

- Do not expose the equipment to rain, moisture, dripping or splashing.
- Do not remove the cover from the equipment.
- Do not insert anything into the equipment through the ventilation holes.
- Do not handle the mains cord with wet hands.
- Do not cover the ventilation with any items such as tablecloths, newspapers, curtains, etc.
- No naked flame sources, such as lighted candles, should be placed on the equipment.
- When disposing of used batteries, please comply with governmental regulations or environmental public instruction's rules that apply in your country or area.
- Make a space of about 0.2 meter around the unit.
- No objects filled with liquids, such as vases, shall be placed on the equipment.
- When the switch is in the OFF position, the equipment is not completely switched off from MAINS.
- The equipment shall be installed near the power supply so that the power supply is easily accessible.
- Do not touch hot spots during and immediately after use.
- During and immediately after use, this product is hot in areas other than the controls and rear panel connection jacks. Do not touch hot spots and especially the top panel. Contact with hot areas can cause burns.
- Do not expose the unit to excessive heat such as direct sunlight, fire or the like.

Français

AVERTISSEMENTS

- Ne pas exposer l'appareil à la pluie, à l'humidité, à l'égouttement ou aux éclaboussures.
- Ne pas essayer de retirer le boîtier de l'appareil.
- Ne rien insérer dans l'appareil par les orifices de ventilation.
- Ne pas manipuler le cordon d'alimentation avec les mains mouillées.
- Ne pas recouvrir les ouïes de ventilation avec un objet quelconque comme une nappe, un journal, un rideau, etc.
- Ne placer aucune source de flamme nue, comme une bougie allumée, sur l'appareil.
- Pour mettre au rebut les piles usées, respecter les lois gouvernementales ou les règlements officiels concernant l'environnement qui s'appliquent à votre pays ou région.
- Veiller à ce qu'aucun objet ne soit à moins de 0,2 mètre des côtés de l'appareil.
- Aucun objet rempli de liquide, un vase par exemple, ne doit être placé sur l'appareil.
- Lorsque l'interrupteur est sur la position OFF, l'appareil n'est pas complètement déconnecté du SECTEUR (MAINS).
- L'appareil sera installé près de la source d'alimentation, de sorte que cette dernière soit facilement accessible.
- Ne pas toucher aux zones chaudes pendant et immédiatement après l'utilisation.
- Pendant l'utilisation et immédiatement après, cet appareil est chaud en dehors des commandes et des prises de raccordement arrière. Ne pas toucher aux zones chaudes, et particulièrement au panneau supérieur, pour éviter tout risque de brûlure.
- Ne pas exposer l'appareil à une chaleur excessive, comme celle des rayons directs du soleil, d'un feu, etc.

Deutsch

WARNHINWEISE

- Das Gerät nicht Regen, Feuchtigkeit, Tropf- oder Spritzwasser aussetzen.
- Die Abdeckung nicht vom Gerät abnehmen.
- Keine Gegenstände durch die Belüftungsschlitze stecken.
- Das Netzkabel nicht mit feuchten oder nassen Händen anfassen.
- Decken Sie die Lüftungsöffnungen nicht mit einem Tischtuch, einer Zeitung, einem Vorhang usw. ab.
- Es dürfen keine Gegenstände mit offener Flamme, wie etwa brennende Kerzen, auf dem Gerät aufgestellt werden.
- Beachten Sie bei der Entsorgung der verbrauchten Batterien alle geltenden lokalen und überregionalen Regelungen.
- Auf allen Geräteseiten muß ein Zwischenraum von ungefähr 0,2 meter vorhanden sein.
- Auf das Gerät dürfen keine mit Flüssigkeiten gefüllte Behälter, wie etwa eine Vase, gestellt werden.
- Wenn der Schalter ausgeschaltet ist (OFF-Position), ist das Gerät nicht vollständig vom Stromnetz (MAINS) abgetrennt.
- Das Gerät sollte in der Nähe einer Netzsteckdose aufgestellt werden, damit es leicht an das Stromnetz angeschlossen werden kann.
- Berühren Sie während oder unmittelbar nach dem Gebrauch keine heißen Stellen des Gerätes.
- Während oder unmittelbar nach dem Gebrauch ist dieses Produkt mit Ausnahme der Bedienelemente und der Anschlussbuchsen auf der Rückseite heiß. Berühren Sie die heißen Stellen und insbesondere die Oberseite nicht. Der Kontakt mit heißen Flächen kann zu Verbrennungen führen.
- Setzen Sie das Gerät keiner übermäßigen Wärme aus, z.B. durch Aufstellung in direkter Sonneneinstrahlung, in der Nähe eines offenen Feuers usw.

Nederlands

WAARSCHUWINGEN

- Stel het apparaat niet bloot aan regen, vocht, druppels of spetters.
- Verwijder de afdekplaat van het apparaat niet.
- Duw niets door de ventilatieopeningen in het apparaat.
- Raak het netsnoer niet met natte handen aan.
- Bedek de ventilatieopeningen niet met enige voorwerpen, zoals tafelkleden, kranten, gordijnen, enz.
- Plaats geen brandende voorwerpen, zoals kaarsen, op het apparaat.
- Volg bij het weggooien van verbruikte batterijen de overheidswetgeving of milieuvoorschriften op die van kracht zijn in het land of de regio waarin u zich bevindt.
- Zorg dat er 0,2 meter vrije ruimte rond het toestel is.
- Plaats geen voorwerpen met een vloeistof erin, zoals een bloemenvaas, op het apparaat.
- Als de schakelaar op OFF staat, is het apparaat niet volledig losgekoppeld van de netspanning (MAINS).
- De apparatuur wordt in de buurt van het stopcontact geïnstalleerd, zodat dit altijd gemakkelijk toegankelijk is.
- Raak hete gedeelten van het apparaat niet aan tijdens en onmiddellijk na het gebruik.
- Tijdens en onmiddellijk na het gebruik is dit product heet, behalve in de omgeving van de bedieningstoetsen en de aansluitingen op het achterpaneel. Raak geen hete plekken aan, vooral niet het bovenpaneel. Contact met hete plekken kan brandwonden veroorzaken.
- Stel het apparaat niet bloot aan grote warmte, zoals direct zonlicht, vuur en dergelijke.

Italiano

AVVERTENZE

- Non esporre l'apparecchio alla pioggia, all'umidità, al gocciolamento o agli spruzzi.
- Non rimuovere il coperchio dell'apparecchio.
- Non introdurre oggetti all'interno dell'apparecchio attraverso i fori di ventilazione.
- Non toccare il cavo di alimentazione con le mani bagnate.
- Non coprire le fessure di ventilazione con tovaglie, giornali, tende od oggetti analoghi.
- Non posare sull'apparecchio sorgenti di fiamme scoperte quali candele accese.
- Smaltire le pile usate in conformità alle norme governative o disposizioni ambientali vigenti nel proprio paese o zona.
- Lasciare 0,2 metro liberi tutto intorno l'unità.
- Non mettere sull'apparecchiatura alcun contenitore di liquido, come ad esempio dei vasi.
- Quando l'interruttore è nella posizione OFF, l'apparecchiatura non è completamente scollegata da MAINS.
- L'apparecchio va installato in prossimità della fonte di alimentazione, in modo che quest'ultima sia facilmente accessibile.
- Non toccare i punti caldi né durante, né immediatamente dopo l'uso.
- Durante, e subito dopo l'utilizzo, questo prodotto risulta essere molto caldo in alcune sue parti come ad esempio i connettori del pannello posteriore. Non toccare i punti caldi e specialmente la superficie del pannello. Il contatto con parti calde può provocare ustioni.
- Non esporre l'unità ad eccessivo calore come la luce diretta del sole, il fuoco o simili.

Thank you for purchasing this Marantz SC-11S1 Stereo Control Amplifier.

Please read these operating instructions carefully. We recommend that you read the entire user guide before you attempt to connect or operate the player.

After you have reviewed the contents of this manual, we suggest that you make all system connections before you attempt to operate the unit.

■ Checking the accessories

After opening the cover of the packing box, check that the following accessories are included.

- Remote controller

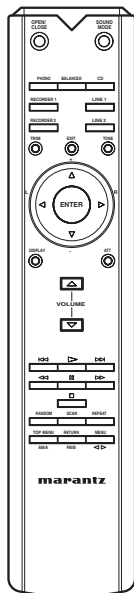

- Size “AAA” batteries x 2

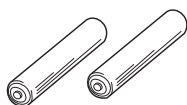

- AC Power cord
SC-11S1 (U.S.A.)

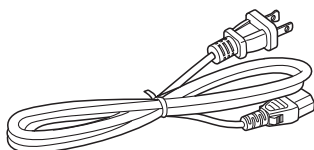

SC-11S1 (Europe)

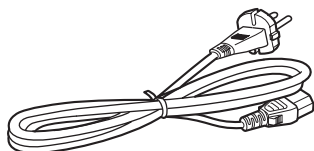

- User Guide
- Warranty Card (U.S.A)
(U.S.A. x 1, Canada x 1)

A NOTE ABOUT RECYCLING



This product’s packaging materials are recyclable and can be reused. This product and the accessories packed together are the applicable product to the WEEE directive except batteries. Please dispose of any materials in accordance with your local recycling regulations. When discarding the unit, comply with your local rules or regulations. Batteries should never be thrown away or incinerated but disposed of in accordance with your local regulations concerning chemical wastes.

CONTENTS

FEATURES	3
BEFORE USING.....	4
EQUIPMENT MAINS WORKING SETTING.....	4
COPYRIGHT	4
INAPPROPRIATE PLACES FOR INSTALLATION	4
NAMES AND FUNCTIONS OF PARTS	6
FRONT PANEL.....	6
DISPLAY	7
REAR PANEL.....	8
REMOTE CONTROLLER	9
CONNECTIONS	11
BALANCED JACKS	11
SPEAKER POSITIONING FOR SUPER AUDIO MULTI-CHANNEL SOUND.....	19
CONNECTING THE POWER SUPPLY	19
BASIC OPERATION.....	20
PLAYBACK.....	20
HOW TO USE AND SET FEATURES.....	21
ATT. (ATTENUATION)	21
SUBSONIC FILTER	21
TRIMMING.....	22
HOW TO OPERATE THE SIDE ILLUMINATION	24
BI-AMP MODE	24
REMOTE POWER CONTROL	25
F.C.B.S.	26
HOW TO SET ID NUMBERS	27
TROUBLESHOOTING.....	28
SPECIFICATIONS & DIMENSIONAL DRAWINGS.....	29
OTHERS	30

FEATURES

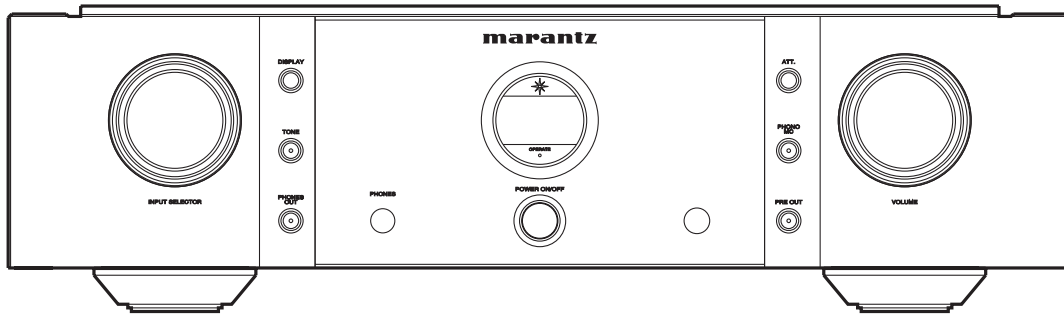

This unit was developed with many of the same functions as the flagship model SC-7S2, without compromising the sound quality.

● HDAM-SA3

The HDAM-SA3 is an amp module equipped with a new circuit that has further improved stability from the previous HDAM-SA and HDAM-SA2. The HDAM-SA3 is an essential part of this unit's amp module, incorporated into many components such as the current-voltage converter and input buffer.

● Constant Current Feedback Phono Equalizer

The new phono equalizer keeps current feedback constant from low to high frequency, and supports both MC and MM cartridges. This has enabled problems in sound quality found in conventional NFB type phono equalizers that resulted from differences in the amount of NFB in the bass and treble regions to be overcome.

● Balanced Linear Control Volume

The newly developed balanced output type volume control amplifier incorporates a combination of the WM8816 by Wolfson with the Marantz original current-feedback amplifier. This balanced linear control amplifier is a high performance amplifier that allow to control the sound volume and to convert the balance signal.

● Balanced Input Headphone System

This is a balanced input current feedback headphone amplifier newly developed for use with the Balanced Linear Control Volume. This power amplifier is special combination of a high quality sound operational amplifier and discrete current-feedback type amplifier specifically for headphone use.

● Input Buffer

With the exception of the PHONO input, each input has its own input buffer that directly uses HDAM-SA3 technology. You will experience superb sound with unbelievable channel separation.

● Choke Input Power Circuit

This unit incorporates a choke input power circuit in order to thoroughly eliminate high frequency noise from the rectifier circuit and external sources. The choke input power supply is a powerful, clean power circuit that stores electrical power in the coil and capacitor, and then supplies it to the amplifier circuit.

● Tone Control

This unit is equipped with an electronic tone control circuit that adjusts the sound balance using the remote control unit. This tone control circuit can be precisely adjusted with the Balance Linear Control Volume.

● Subsonic Filter

Subsonic signals are intercepted in the cut-off frequency 15Hz (12dB/oct) by the subsonic filter. The subsonic filter is an active filter used in the HDAM-SA3.

● F.C.B.S.

A Floating Control Bus System (F.C.B.S.) enables the user to connect up to four units, making a diversity of applications possible with bi-amp and multi-channel connections. Moreover, a ground loop is not formed between multiple connected amplifiers, therefore sound quality is not adversely affected.

● BI-AMP Mode

The operating mode that uses the complete bi-amp connection proposed by Marantz. Complete bi-amp allows two SC-11S1 to be connected by F.C.B.S. enabling each to work as a monaural Integrated amplifier.

● Display

This unit adopts an LCD (Liquid Crystal Display) to display input source and volume level. Compared to other types of display panels, an LCD generates less drive noise and radiation noise, hence the interference in sound quality is minimal.

● Remote Power Control

This unit is equipped with a trigger output jack that can simultaneously operate the power ON/OFF control of a Marantz SM-11S1 power amplifier in sync with the power ON/OFF control of this unit. Up to two SM-11S1 can be connected to this unit. As with the F.C.B.S. a ground floating connection is made without a ground loop being formed, therefore sound quality is not adversely affected.

BEFORE USING

This section must be read before any connection is made to the mains supply.

EQUIPMENT MAINS WORKING SETTING

Your Marantz product has been prepared to comply with the household power and safety requirements that exist in your area.

- Power requirements (U.S.A.)AC 120V 60Hz
- Power requirements (Europe)AC 230V 50/60Hz

COPYRIGHT

Recording and playback of any material may require consent. For further information refer to the following:

- Copyright Act 1956
- Dramatic and Musical Performers Act 1958
- Performers Protection Acts 1963 and 1972
- Any subsequent statutory enactments and orders

INAPPROPRIATE PLACES FOR INSTALLATION

To keep your player in perfect working order for the longest possible time, avoid installing the player in the following locations.

- Wherever it will be exposed to direct sunlight
- Wherever it will be close to a heater or other heat-radiating appliance
- Wherever the humidity is high or ventilation is poor
- Wherever it is very dusty
- Wherever it will be subject to vibration
- On top of a rickety stand or in an unstable location which is tilted at an angle
- In an audio rack with little space at the top and bottom or other location where the heat dissipation will be obstructed

To ensure proper heat dissipation, install the player while leaving clearances between the player and wall or other components, as shown in the figure below.

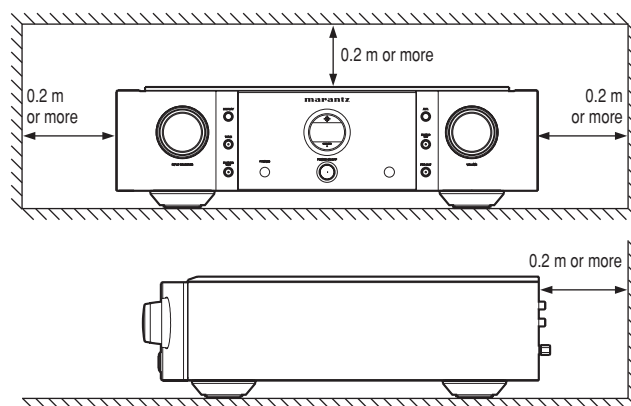

■ Do not place objects on top

- Refrain from placing any objects on top of the player.

■ Cautions on handling power cord

- Do not touch the power cord with wet hands.
- When disconnecting the power cord, always make sure that you take hold of the plug. Yanking out or bending the cord can damage it and/or cause electric shocks or a fire.
- Get into the habit of disconnecting the power plug before leaving home.

BEFORE USING

■ Loading batteries

Before using the remote controller for the first time, load the batteries in the remote controller. The batteries provided are used to verify the operations of the remote controller only.

1. Remove the battery cover.

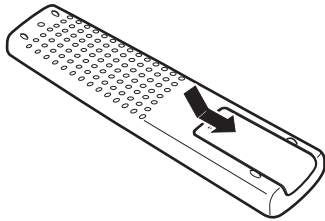

2. Insert the batteries with correct +/– orientation.

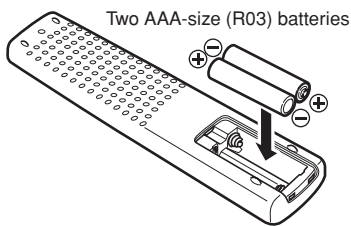

3. Close the battery cover until it clicks shut.

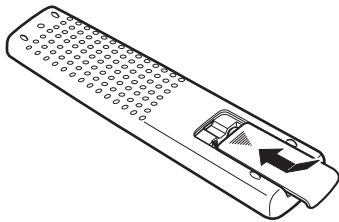

■ Cautions on handling batteries

Misuse of the batteries can result in electrolyte leakage, rupturing, corrosion, etc.

Bear in mind the following points when using batteries.

- Remove the batteries from the remote control unit if the unit is not going to be used for a prolonged period (a month or more).
- Do not use an old battery together with a new one.
- Insert the batteries while ensuring that their ⊕ and ⊖ poles are properly aligned with the corresponding markings on the remote control unit.
- Batteries with the same shape may have different voltages. Do not use different types of batteries together.
- If electrolyte has leaked, thoroughly wipe the inside of the battery compartment, and then insert new batteries.
- When batteries which are no longer required are to be discarded, follow the directions (regulations) laid down by the local authorities in the area concerned for their disposal.

■ Usage of remote controller

Operational range

Operate the unit with the remote controller within the range of the illustration below.

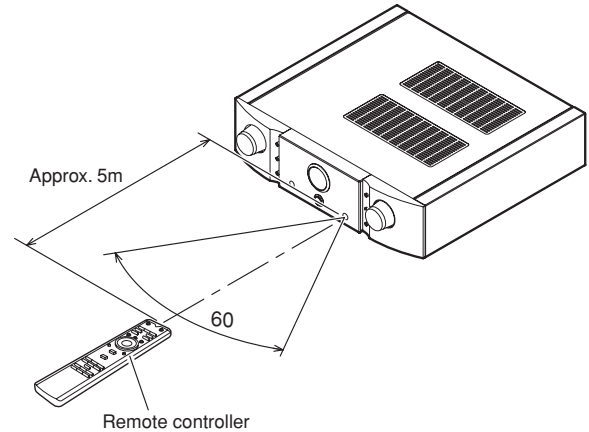

Precautions

- Do not allow direct sunlight, an inverter fluorescent light or other strong source of light to shine onto the player's infrared signal reception window (remote sensor). Otherwise, the operation of the remote control unit may be disabled.
- Bear in mind that operating the remote control unit may cause other devices operated by infrared rays to be operated by mistake.
- The remote control unit cannot be operated if the space between the controller and the player's remote sensor is obstructed.
- Do not place any objects on top of the remote control unit. Doing so may cause one or more buttons to be held down which will cause the batteries to run down.

NAMES AND FUNCTIONS OF PARTS

FRONT PANEL

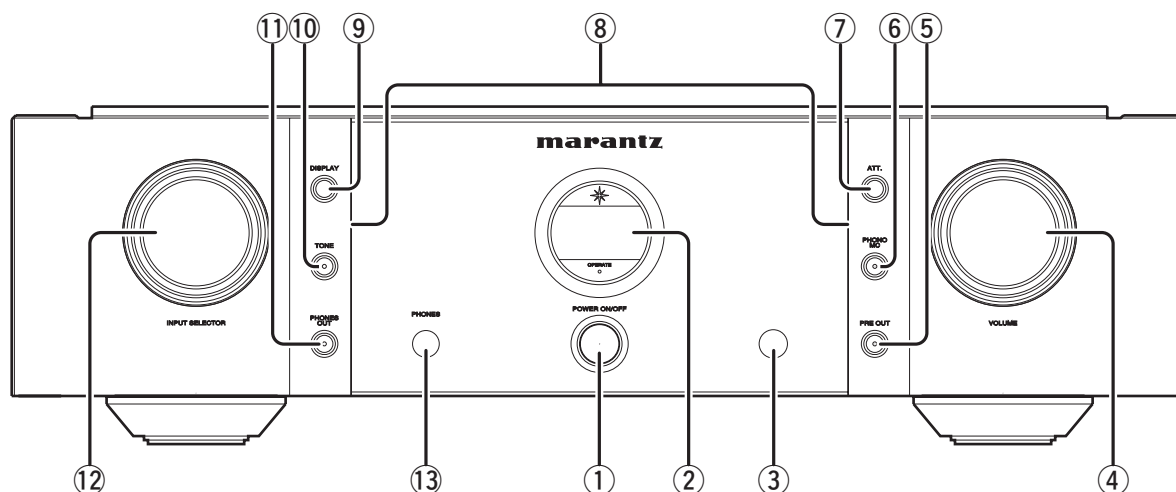

① POWER ON/OFF Switch

This switch turns power to the unit ON and OFF. When pressed, power is activated and the blue indicator in the display ② lights up. Pressing the switch again turns the power OFF.

② Display

Indicate the selected input source, volume level, and setting status.

③ Infrared Receptor Window

This receptor window receives control signals sent from the included remote controller.

④ VOLUME Knob

This knob is for setting the volume. The volume level is displayed on the display ②. When turned slowly, the volume can be fine-adjusted in 0.5dB steps, whereas when turned rapidly, the volume level changes greatly.

⑤ PRE OUT Button

This buttons turns output from the PRE OUT jack and BALANCED PREOUT jack on the rear panel ON and OFF. When using just the headphones, switch this button OFF.

⑥ PHONO MC Button

This button switches the Phono equalizer amplifier setting between MC and MM. Set the phono equalizer amplifier according to the type of cartridge you use.

⑦ ATT. Button

This button attenuates the volume with one press of the button. For instructions on **How to Set the Attenuation Level**, see page. 21.

⑧ Illumination Lamp

The illumination lamp casts a blue light over the switches and buttons. It can be turned ON and OFF with the DISPLAY button. For instructions on **HOW TO OPERATE THE SIDE ILLUMINATION**, see page. 24.

⑨ DISPLAY Button

This button turns the display and side illumination ON and OFF. For instructions on **HOW TO OPERATE THE SIDE ILLUMINATION**, see page. 24.

⑩ TONE Button

This button turns the bass and treble tone control ON and OFF. For instructions on **How to Trim Bass and Treble**, see page. 23. If pressed and held for 2 seconds or longer, this button switches the subsonic filter ON/OFF. For details on **SUBSONIC FILTER**, see page 21.

⑪ PHONES OUT Button

This button switches the headphone jack output signal ON/OFF. Set this to OFF when not in use.

⑫ INPUT SELECTOR Knob

This knob is for selecting the input source to use in playback and recording. The selected input source is displayed in the display ②.

⑬ PHONES Jack

This jack is for connecting headphones with a standard stereo plug.

NAMES AND FUNCTIONS OF PARTS

DISPLAY

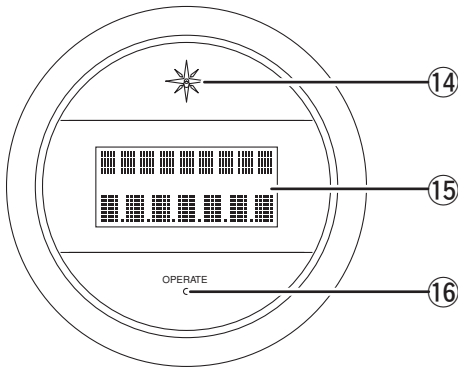

14 Power Indicator

This indicator is lit a blue color while power to the unit is ON.

15 Display Panel

Approximately 3 seconds after the power to the unit is activated, the ID number is displayed here.



After that, the top line displays the selected input source, and the bottom line displays the volume level. The volume attenuation (dB units) is displayed.



VOLUME Indicator Volume Display

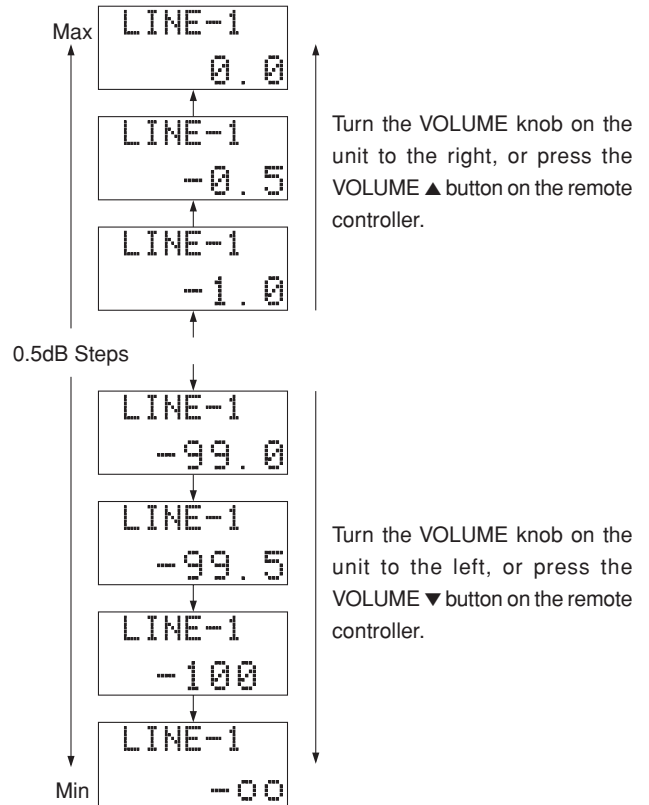

The display also displays the setting values when adjusting the left-right level balance. For instructions on **How to Trim Volume Level**, see page. 22. Other messages that correspond to various operations are also displayed.

16 OPERATE Indicator

This indicator flashes the operating status of the unit. When the ID is set to "0" for standalone operation, it is lit a red color. When multiple amplifiers are connected by F.C.B.S., only ID number "1" for the master is lit red color. The slave amplifier whose indicator does not light a red color cannot be used to operate other units in sync. For more information on **F.C.B.S.**, see page. 26. The indicator flashes red if a protective circuit trips.

NAMES AND FUNCTIONS OF PARTS

REAR PANEL

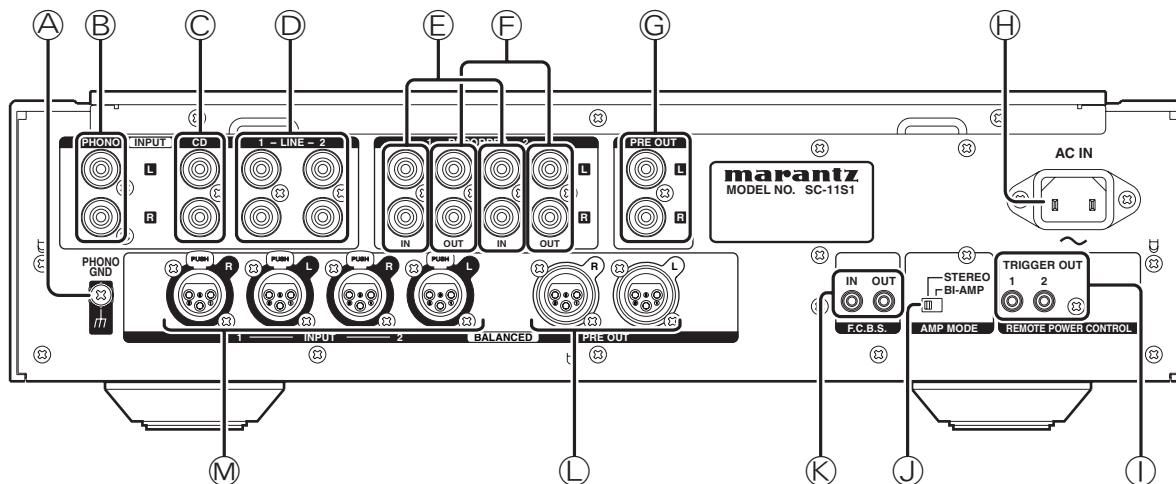

Ⓐ PHONO GND Terminal

Connect the grounding wire from an analog record player here.

Ⓑ PHONO Input Jacks

These jacks are for connecting to an analog record player. Both MC and MM cartridges can be used, therefore set the PHONO MC button ⑥ on the front panel according to the type of cartridge you are using.

Ⓒ CD Input Jacks

These jacks are for connecting to the output jacks of a Super Audio CD player, etc.

Ⓓ LINE 1/2 Input Jacks

These jacks are for connecting to the output jacks of a tuner, DVD player, etc.

Ⓔ RECORDER 1/2 Input Jacks

These jacks are for connecting to the output jacks of a tape deck or other type of recording device.

Ⓕ RECORDER 1/2 Output Jacks

These jacks are for connecting to the recording input jacks of a tape deck etc.

Ⓖ PRE OUT Jacks

These jacks are for connecting to the input jacks of a power amplifier.

Ⓗ AC IN Power Cable Connection Socket

Connect this socket to the power outlet using the included power cable.

Ⓘ REMOTE POWER CONTROL Jack (TRIGGER OUT)

This jack is for connecting to the TRIGGER IN jack of a Marantz SM-11S1 stereo powered amplifier used when simultaneously switching the power of both devices ON/OFF. For more information on **REMOTE POWER CONTROL**, see page. 25.

Ⓙ AMP MODE Switch

STEREO: Set to use this unit as an ordinary stereo control amplifier.

BI-AMP: Set to use this unit in complete bi-amp connection.

For more information on **BI-AMP MODE**, see page. 24.

Ⓚ F.C.B.S. IN/OUT Jacks

These jacks are used to connect and synchronize up to four amplifiers. For instructions on use and connections, see **F.C.B.S.** (page. 26).

Ⓛ BALANCED PRE OUT Jacks

These jacks are for connecting to the balanced input jacks of a power amplifier.

Ⓜ BALANCED INPUT 1/2 Jacks

These jacks are for connecting to the balanced output jacks of a Super Audio CD player, etc.

NAMES AND FUNCTIONS OF PARTS

REMOTE CONTROLLER

This remote controller can be used to control the SC-11S1 and Marantz Super Audio CD players or DVD players that have a remote control receptor. The operations possible by remote control may differ with each component, therefore see the instruction manual that came with the component.

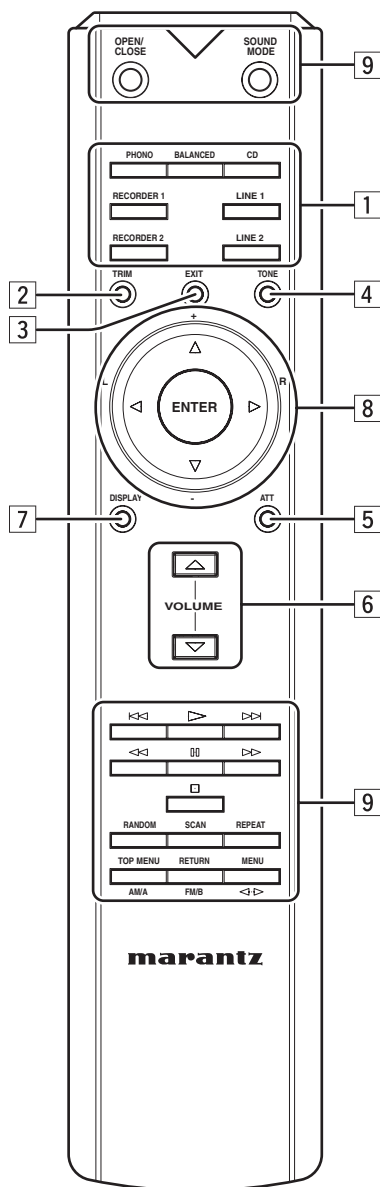

1 Input Selector Buttons

These buttons are for selecting the input source to use in playback.

2 TRIM Button

This button starts the various trim adjustments. (Page. 22)

When multiple units are connected by F.C.B.S., this button selects the unit with which to perform trimming.

3 EXIT Button

This button ends the trimming mode when trimming is finished.

4 TONE Button

This button turns tone (bass /treble) control ON and OFF.

5 ATT Button

This button attenuates volume level with one press. (page. 21)

6 Volume Buttons

- ▲ : This button increases the volume level.
- ▼ : This button decreases the volume level.

7 DISPLAY Button

This button turns the display ON and OFF.

8 Cursor Buttons

In the Trimming Mode

These buttons are for selecting the channel to trim and the trimming level.

ENTER : This button selects the trim mode (LEVEL/BASS/TREBLE).

▶ / R : This button selects the R channel for trimming.

◀ / L : This button selects the L channel for trimming.

▲ / + : This button increases the trimming level.

▼ / - : This button decreases the trimming level.

Other than the Trimming Mode

▶, ◀, ▲, ▼ and ENTER: These buttons are for selecting settings items on menu displays of Marantz DVD players, etc. For operations of supported Marantz products, see the tables on the following page and the instruction manual of the Marantz component.

9 Component Operating Buttons

These buttons are for operating Marantz Super Audio CD players, DVD players, etc. For operations of supported Marantz products, see the tables on the following page and the instruction manual of the Marantz component.

NAMES AND FUNCTIONS OF PARTS

The buttons in groups [8] and [9] are for operating Marantz products other than the SC-11S1, such as Super Audio CD players or DVD players.

The function of each button changes to match the component selected as the input source from the INPUT SELECT buttons [1].

● Remote Controller Operation for Marantz Super Audio CD Players

When the CD button is pressed, the buttons in groups [8] and [9] function as indicated in the table below. These buttons can be used only when a Marantz Super Audio CD player is connected to the CD input jacks.

Button	Function
OPEN/CLOSE	Open/Closes disc tray.
SOUND MODE	Selects Super Audio CD sound mode. Selects Super Audio CD/CD.
▶	Play
⏮	Track skip (Returns to track beginning/previous track.)
⏭	Track skip (Advances to next track.)
⏪	Rewind search
⏩	Forward search
⏸	Pause
■	Stop
RANDAM	Random play
SCAN	AMS (Automatic Music Scan) play
REPEAT	Repeat play
TOP MENU/AM/A	Not available for use
RETURN/FM/B	Not available for use
MENU ◀▶	Sets quick replay.
ENTER	Starts quick replay.
▲ / +	Not available for use
▼ / -	Not available for use
◀ / L	Not available for use
▶ / R	Not available for use

● Remote Controller Operation for Marantz DVD Players

When the LINE 2 button is pressed, the buttons in groups [8] and [9] function as indicated in the below table. These buttons can be used only when a Marantz DVD player is connected to the LINE 2 input jacks.

Button	Function
OPEN/CLOSE	Open/Closes disc tray.
SOUND MODE	Changes sound mode.
▶	Play
⏮	Track skip (Returns to track beginning/previous track.)
⏭	Track skip (Advances to next track.)
⏪	Rewind search
⏩	Forward search
⏸	Pause
■	Stop
RANDAM	Random play
SCAN	Selects search mode.
REPEAT	Repeat play
TOP MENU/AM/A	Displays top menu.
RETURN/FM/B	Returns to previous menu
MENU ◀▶	Displays menu screen.
ENTER	Sets selected item.
▲ / +	Moves cursor upward.
▼ / -	Moves cursor downward.
◀ / L	Moves cursor to left.
▶ / R	Moves cursor to right.

CONNECTIONS

Connection examples 1~3 are examples of connecting to a Marantz SM-11S1 stereo power amplifier.

Refer to these connection examples when connecting to different amplifiers.

Notes:

- Do not connect the power cord of this unit or any of the other components to the power supply until all of the connections are completed.
- Insert the plugs of the connections cords firmly into the connecting jacks. Incorrect insertion may cause noise.
- Connect the wires correctly to the L (left) and R (right) channels. The red jack is the R (right) channel, and the white jack is the L (left) channel.
- Make sure that input and output are connected correctly.
- Refer also to the instruction manuals of components to connect equipment correctly.

BALANCED JACKS

- ① The BALANCED jacks on this unit are equipped with XLR connectors that are widely used on professional equipment. Their features are listed below.

- The 3 pin construction enables the musical signal to be transmitted as a balanced signal, with little effect from external noise
- The detachable locking mechanism minimizes connector play and enhances connection reliability.

- ② The XLR connector for professional use is internally wired in either of the following two systems.

1. USA system (Pin ② = COLD, Pin ③ = HOT)

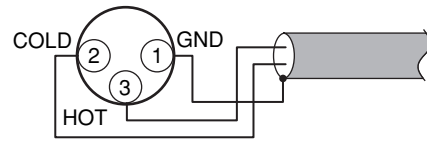

2. European system (Pin ② = HOT, Pin ③ = COLD)

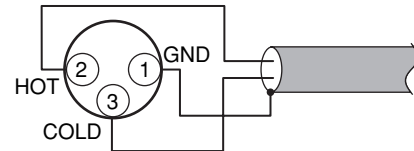

- ③ This unit uses the 1. USA system.

When a preamp or main amplifier adopting the European system is connected using a cable with XLR balanced connectors, the reproduced signal may be inverted of phase.

In this case, refer to “ANALOG OUTPUT CONNECTOR PHASE SWITCHING”, and set so that the correct phase is used.

CONNECTIONS

■ Connection Example 1: Basic Connection for Normal Stereo Playback
 Connection Example with Input Source Components

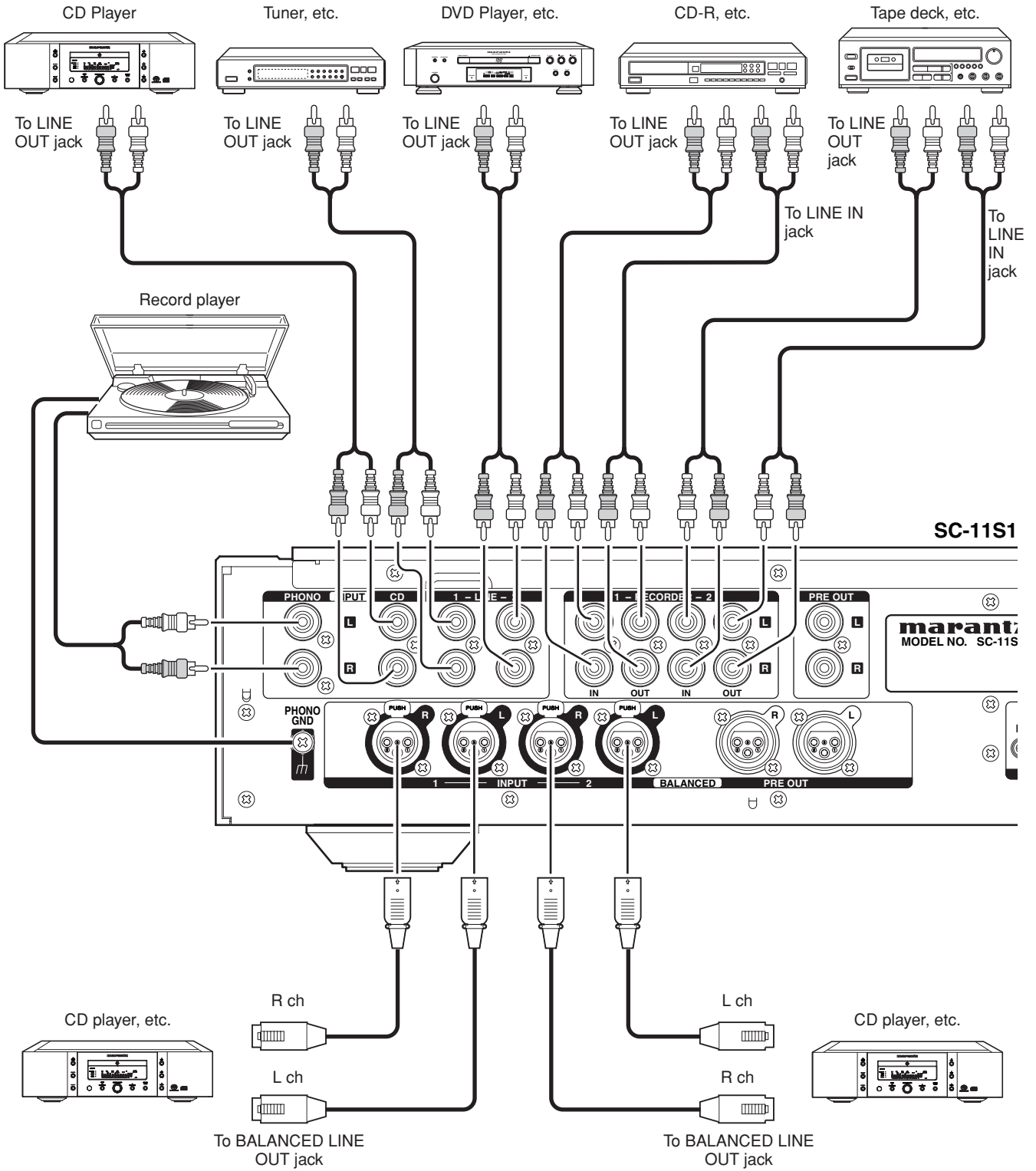

CONNECTIONS

Connection example to power amplifier

- Set the PRE OUT button on the front panel to ON.

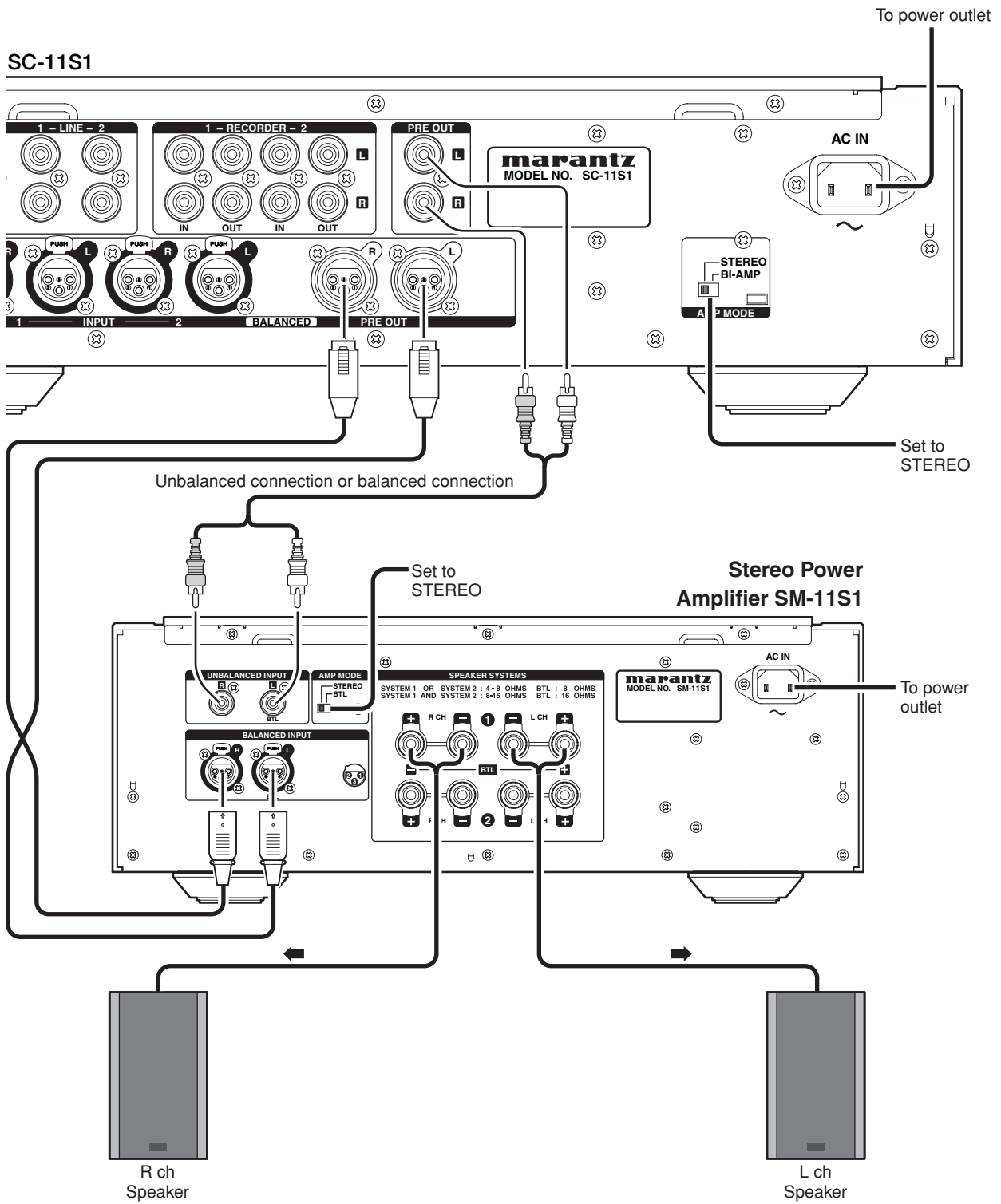

CONNECTIONS

■ Connection Example 2: Stereo Complete Bi-amp Connection

- ① The two amplifiers are connected by F.C.B.S. for synchronized use. For F.C.B.S. connection, connect with commercially available monaural ⇔ monaural miniplugs or stereo ⇔ stereo miniplugs as described in **F.C.B.S.** (page. 26).
- ② Set the ID numbers as explained in **HOW TO SET ID NUMBERS** (page. 27). When the ID1 amplifier is operated, the ID 2 amplifier will operate in sync.
- ③ Connect the analog output of the CD player etc. to the L ch input jacks of both pre-amps.
As both pre-amps operate as monaural pre-amps in BI-AMP mode, do not use the R channel of the input jacks on these units.

● About Complete Bi-Amp

Proposed by Marantz, the complete bi-amp connection is an advanced technique that enhances sound quality. The low and mid/high amplifiers are separated and independent of the preamplifier, therefore interference between low and mid/high sounds is reduced to a minimum. As a result, a wide sound environment can be reproduced.

Note:

Speaker systems connected using complete bi-amp connections must support bi-amp connections. Before connecting your speakers, check in the instruction manual that came with the speakers or contact the manufacturer to confirm whether they support bi-amp connection.

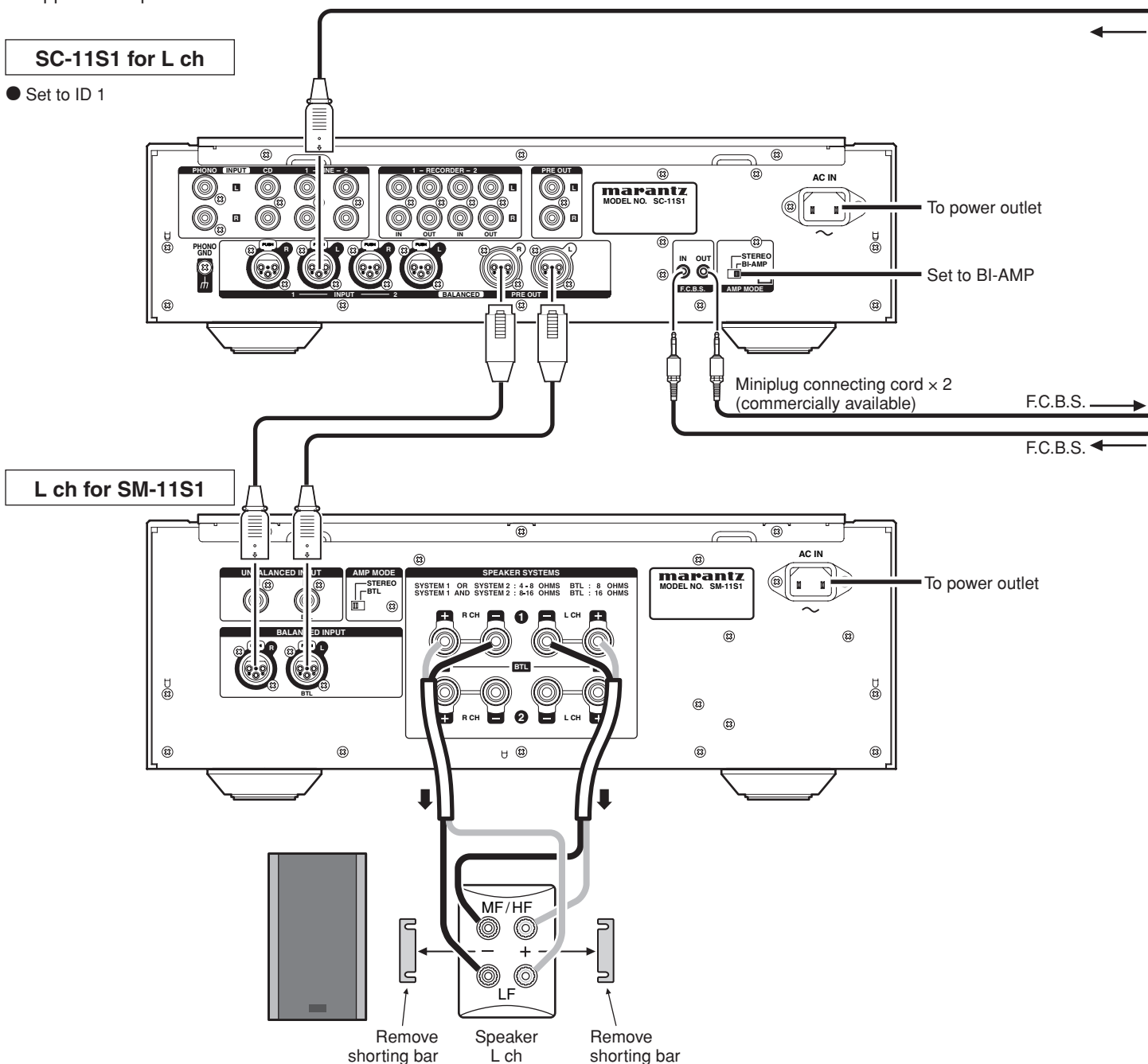

CONNECTIONS

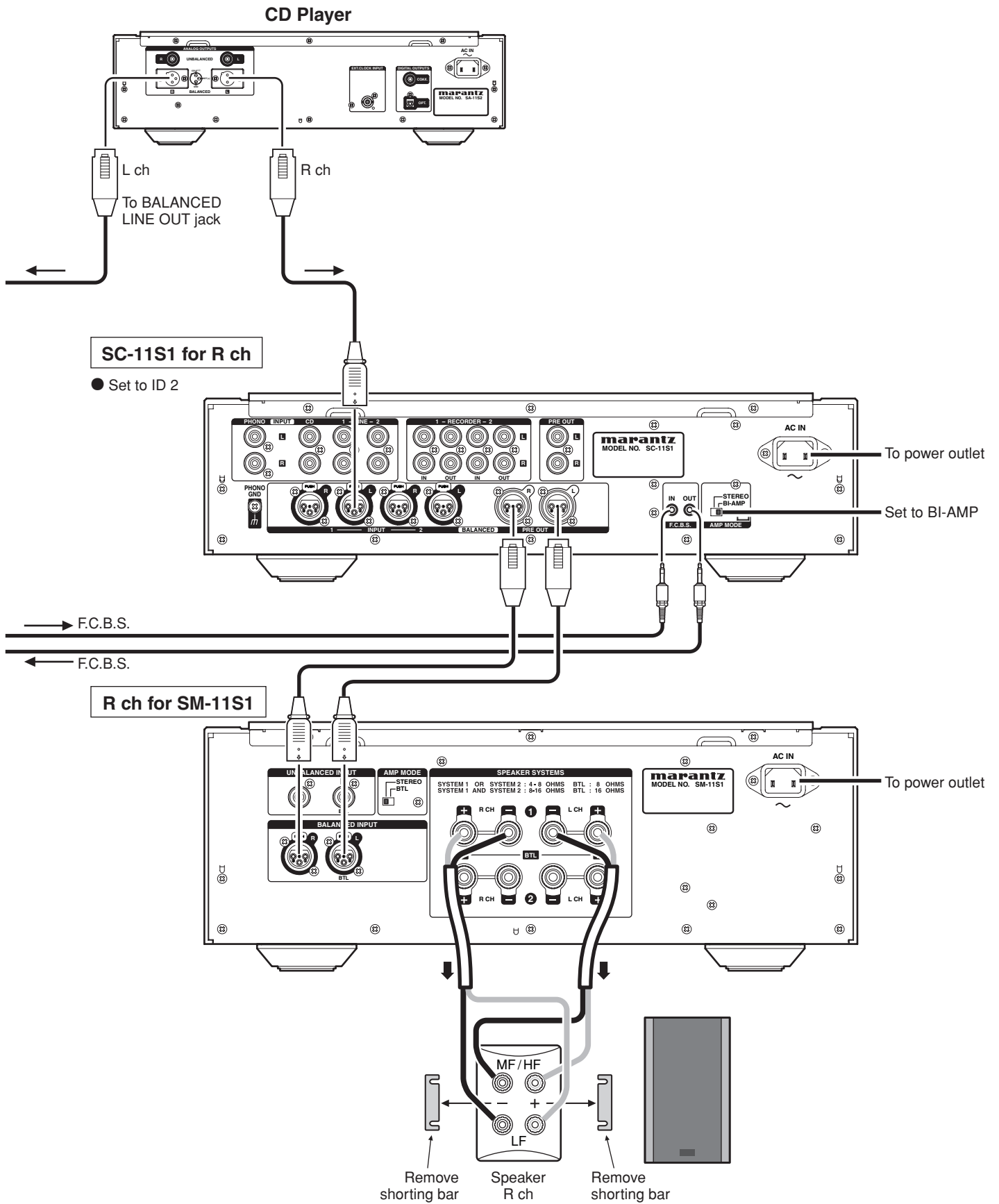

CONNECTIONS

■ Connection Example 3: Basic Connection for 5.1 Multi-Channel Playback

- ① The three units are connected using F.C.B.S. For the F.C.B.S. connection, prepare 3 audio connection cables, and refer to **F.C.B.S.** on page 26.
- ② Set the ID numbers for the three amplifiers as explained in **HOW TO SET ID NUMBERS** (page. 27). When the ID 1 pre-amp is operated, ID 2 and ID 3 pre-amps will operate in sync.
- ③ Connect the outputs of players that have 5.1 channel analog outputs to each of the three pre-amps.
- ④ If using an active subwoofer, see the instruction manual that came with the subwoofer for further instructions.

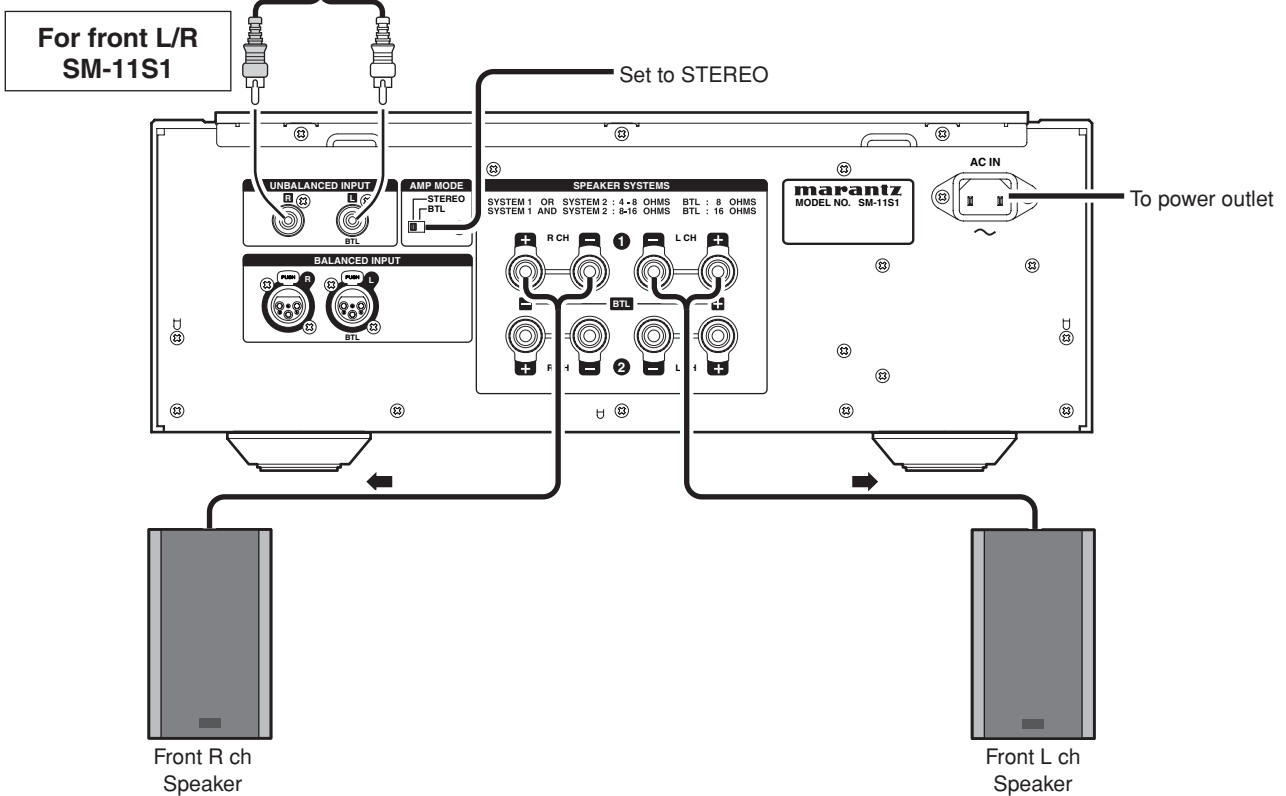
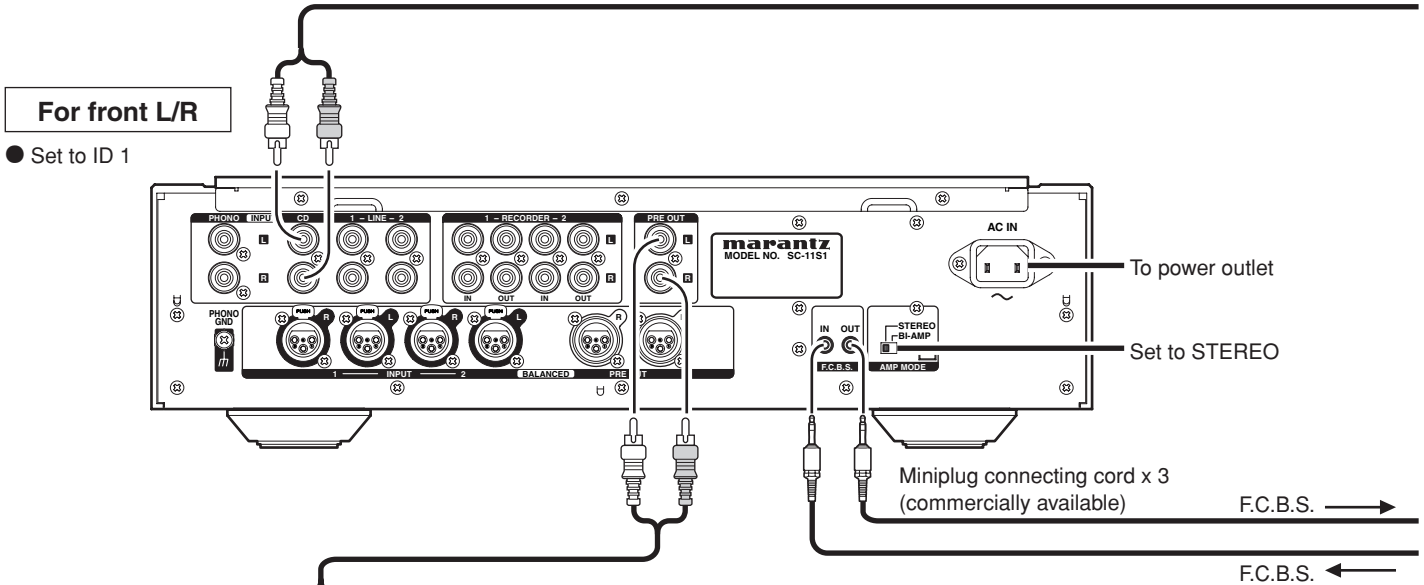

CONNECTIONS

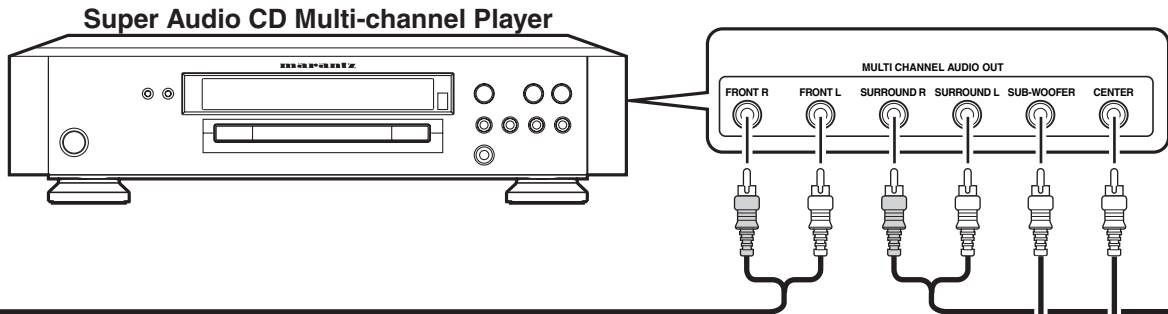

to page. 18

For center/
subwoofer

● Set to ID 2

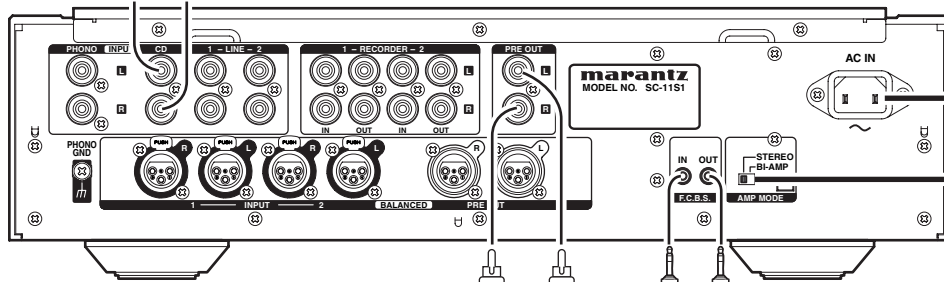

To power outlet

Set to STEREO

to page. 18

For center
SM-11S1

Set to STEREO

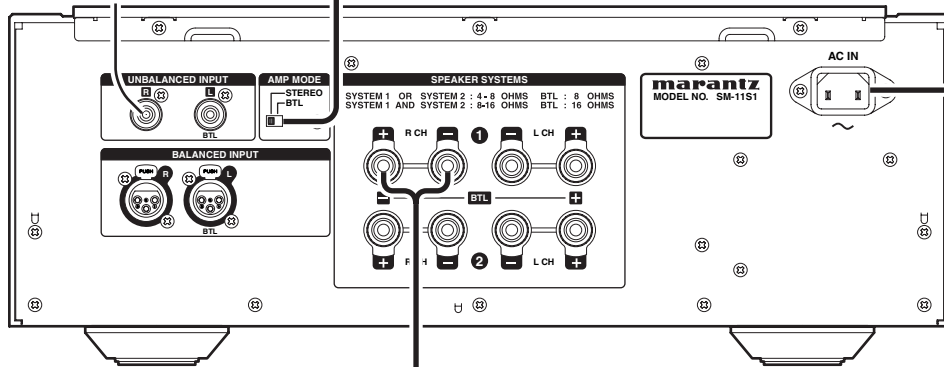

To power outlet

To line input
jack

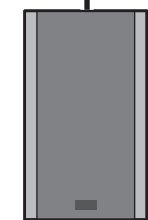

Center speaker

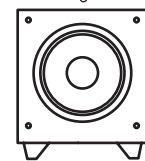

Amplifier built-in
subwoofer

CONNECTIONS

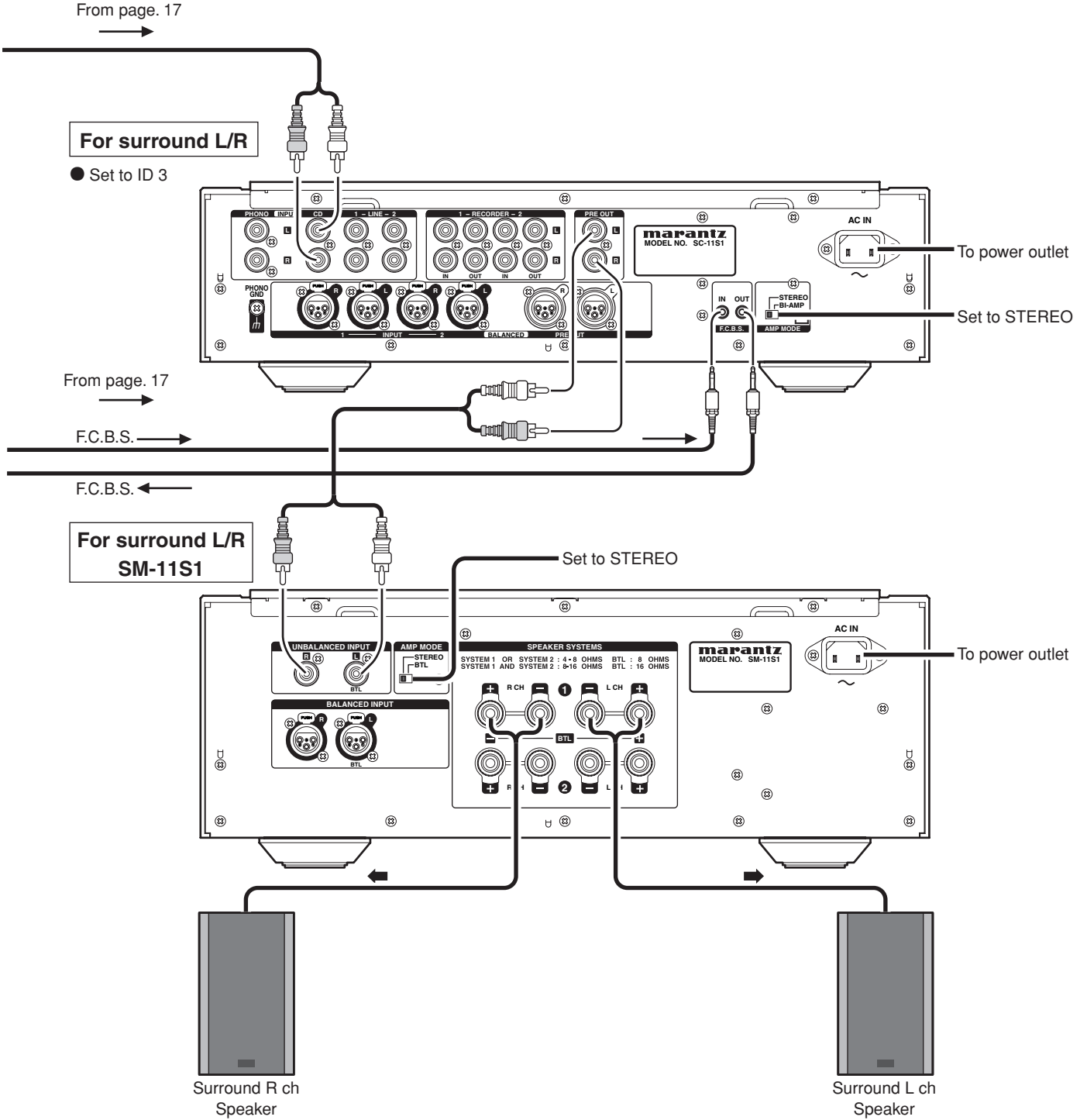

CONNECTIONS

SPEAKER POSITIONING FOR SUPER AUDIO MULTI-CHANNEL SOUND

In order to enjoy Super Audio CD multi-channel sound with the best possible acoustics, it is recommended to position speakers as specified in ITU-R BS.775-1 of the International Telecommunication Union (ITU). Super Audio CD multi-channel discs are recorded and mixed so as to achieve the optimum effect with a speaker system laid out as specified in ITU-R BS.775-1.

- With Super Audio CD multi-channel discs, the music signals are basically recorded using 5 channels (3 - 6 channels sometimes), but in some cases, LFE (for subwoofer) is recorded as a sixth channel. Each disc indicates how many channels have been recorded on it.
- The basic layout is 3 speakers in the front and 2 in the back since multi-channel discs usually have 5 channels. The 2 front, 1 center and 2 surround (rear) speakers should be set in a circle around the listening point as shown below. If using speakers of differing sizes, adjust volume balance from the amplifier.
- The location of the subwoofer in the figure is just for explanatory purposes. It can be located anywhere in the room. For connection and positioning instructions, see the instruction manual that came with the subwoofer.

● ITU (International Telecommunication Union)

The ITU is a special organization of the United Nations. It consists of a number of organs, one of which is the Radio Broadcasting Section.

ITU-R BS in the recommendation which consists of standards relating to broadcasting (audio) operations, one of which is the ITU-R BS.775-1 which governs "multi-channel stereo sound systems."

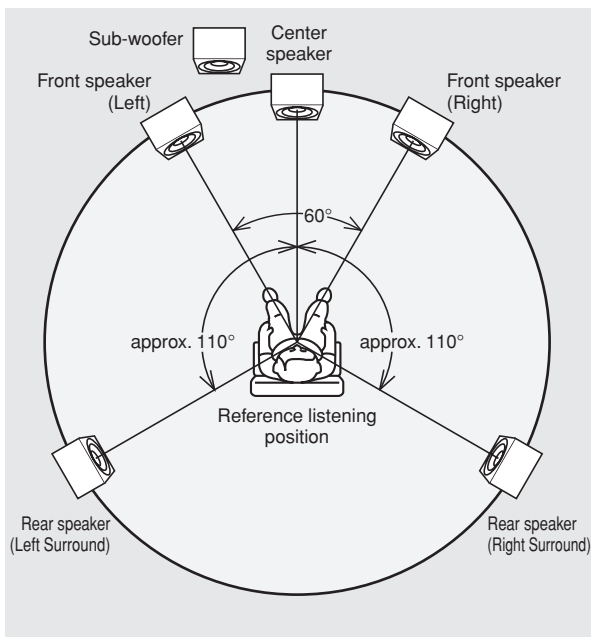

CONNECTING THE POWER SUPPLY

1. Plug the power cable into AC IN jack on the back panel.

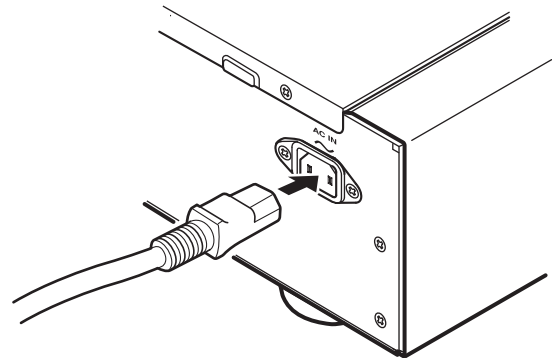

2. Turn on the power switch of the audio unit (amplifier, etc.) that is connected with this unit. Set the selector on the connected unit to this unit.
3. Plug the power cable into an AC outlet.

BASIC OPERATION

PLAYBACK

To explain how to play back input sources, typical examples are given with disc playback from a Super Audio CD player and record playback from an analog record player.

Refer to the connection procedures and check that each component is correctly connected to the amplifier.

■ Disc Playback on a Super Audio CD Player

1. Press the power ON/OFF switch of the Super Audio CD player to activate power to it.
2. Press the power ON/OFF switch ① on the unit to activate power to it. When using multiple amplifiers connected by F.C.B.S., turn the power ON in the order of lowest to highest ID number.
3. Select the input source from the INPUT SELECTOR knob ⑫ on the unit, or the INPUT SELECT buttons ① of the remote controller.
4. Press the PRE OUT ⑤ button to switch output from the unit ON.
5. Turn on the power to the connected power amp.
6. Load a disc into the Super Audio CD player and press the PLAY button to start playback.
7. Adjust the volume level using the VOLUME knob ④ on the unit or the VOLUME ▲/▼ buttons ⑥ on the remote controller.
8. You can turn the display and side illumination ON/OFF as suited for the room environment. Press the DISPLAY button ⑨ on the unit or the DISPLAY button ⑦ on the remote controller.

■ Disc Playback on an Analog Record Player

1. Press the power ON/OFF ① switch of the unit to activate power to it. When using multiple amplifiers connected by F.C.B.S., turn the power ON in the order of lowest to highest ID number.
2. Select the PHONO using the INPUT SELECTOR knob ④ on the unit, or the INPUT SELECT buttons ① of the remote controller. To prevent unexpected accidents, it is recommended to set the volume level to $-\infty$ (mute) by turning the VOLUME knob ④.
3. Set the PHONO MC button ⑥ to MM or MC according to the cartridge you are using.
4. Press the PRE OUT ⑤ button to switch output from the unit ON.
5. Turn on the power to the connected power amp.
6. Set a record on the analog record player and play it.
7. Adjust the volume level using the VOLUME knob ④ on the unit or the VOLUME ▲/▼ buttons ⑥ on the remote controller.
8. You can turn the display and side illumination ON/OFF as suited for the room environment. Press the DISPLAY button ⑨ on the unit or the DISPLAY button ⑦ on the remote controller.

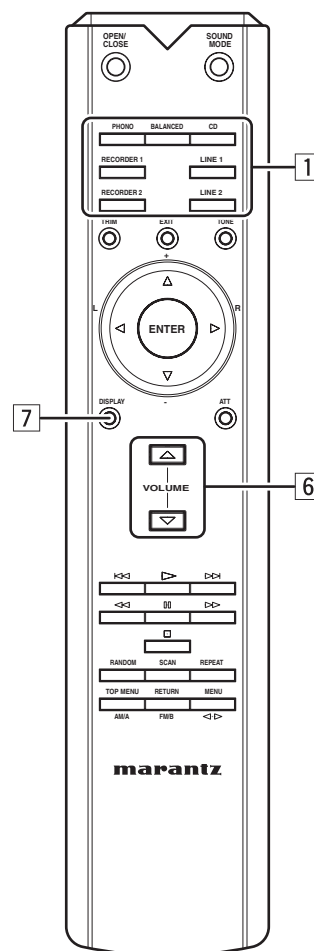
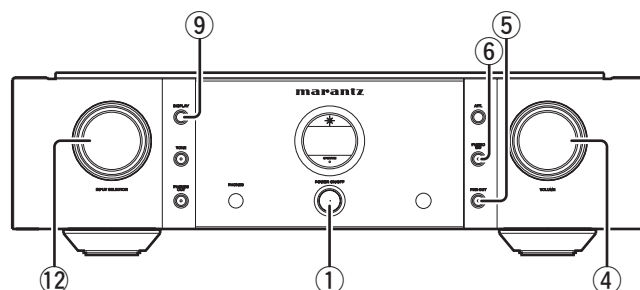

HOW TO USE AND SET FEATURES

ATT. (ATTENUATION)

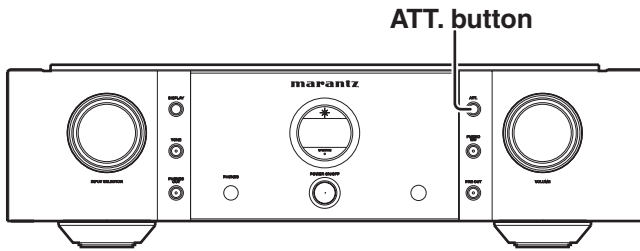

ATT is a one-touch feature for reducing the volume level. When the ATT button on either the unit or remote controller is pressed, the volume level is attenuated.

1. When the ATT button on either the unit or the remote controller is pressed, "ATT" flashes on the display and the volume level is reduced.

When the ATT button is pressed again or the volume is increased/decreased using the controls, the mode is canceled and the original volume level is restored.

```
LINE-1
ATT
```

2. When the ATT button is pressed with the volume level at $-\infty$ (muted), the display will change as it is shown below appears for about 3 seconds, and attenuation is not applied.

```
LINE-1
MIN
```

How to Set Attenuation Level

Attenuation level can only be set using the ATT button on the unit. The attenuation level can be set at -20dB , -40dB , or $-\infty$. The factory default setting is -20dB .

1. Press and hold the ATT button on the unit for 2 seconds or longer. The attenuation level will appear on the display.

```
LINE-1
ATT -20
```

2. The attenuation level setting value changes with each press of the ATT button on the unit.
3. When the desired attenuation level setting appears on the display, leave it unchanged for 2 seconds or longer to enter the setting. Once entered, the display returns to the volume level indication.

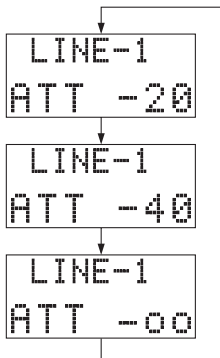

SUBSONIC FILTER

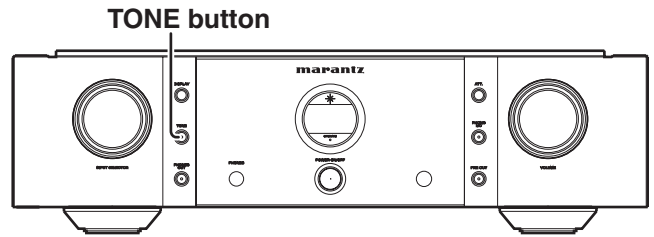

If a warped analog record or disc recorded with super-low bass is played, the speaker diaphragm may vibrate unusually and the disc may not be played correctly.

In such cases, the subsonic filter can be set to block the super-low bass output component. Press the TONE button for 2 seconds or more to set the subsonic filter ON/OFF.

When the subsonic filter is switched from ON to OFF, the ON/OFF condition of the subsonic filter is displayed for 3 seconds, as shown below.

After displaying the ON/OFF condition, the display returns to the volume display.

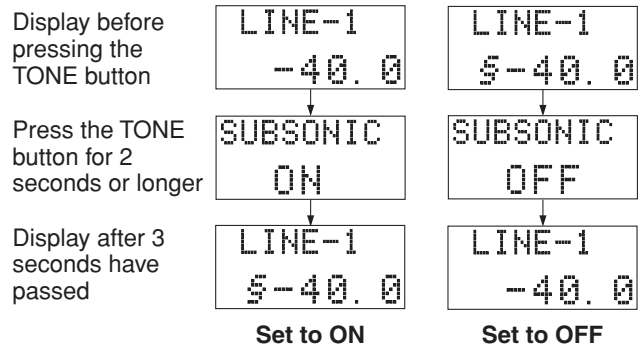

HOW TO USE AND SET FEATURES

TRIMMING

There are three trimming modes.

- LEVEL trimming that adjusts the volume level on left and right channels
- BASS trimming that adjusts the bass on left and right channels
- TREBLE trimming that adjusts the treble on left and right channels

Note:

Trimming is performed from the remote controller.

TRIM : This button starts trimming. When multiple SC-11S1s are connected, this button selects the amplifier with which to perform trimming. In such case, trimming is performed in the order of the lowest to highest ID number.

EXIT : This button ends trimming.

- ▲ : This button increases the trimming level.
- ▼ : This button decreases the trimming level.
- ▶ : This button selects the R channel for trimming.
- ◀ : This button selects the L channel for trimming.

ENTER : This button selects the trim mode (LEVEL, BASS or TREBLE).

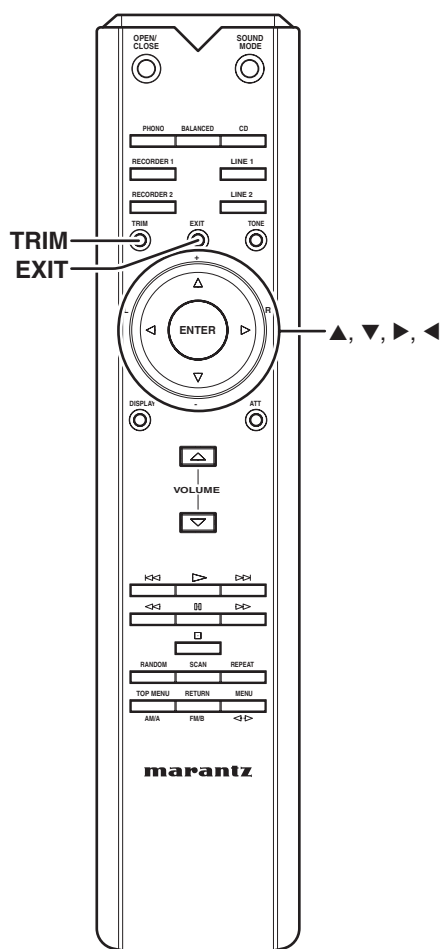

How to Trim Volume Level

The volume level of the left and right channels can be trimmed in 0.5dB steps across a 0.0 – 9.0dB range. When the unit is shipped from the factory, the volume level is set to 0.0dB (maximum).

1. Press the TRIM button once to access the LEVEL trimming mode.



2. The flashing "0.0" on the left indicates that trimming is activated for the left channel volume level. Press the ▲ and ▼ buttons to set the volume level of the left channel.



3. Press the ▶ button to set the right channel volume level. When the right side "0.0" starts flashing, trimming is activated for the right channel volume level. Press the ▲ and ▼ buttons to set the volume level of the right channel.

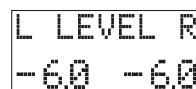

4. To trim the volume level of the ID 2 (slave) unit, press the TRIM button again and set the volume level as in steps 1~3. After that, pressing the TRIM button again allows you to trim the volume level for the "ID 3" unit and so forth.

5. When finished with volume level trimming, press the EXIT button.

HOW TO USE AND SET FEATURES

■ How to Trim Bass

The bass level of the left and right channels can be trimmed in 2dB steps across a $-8.0 - +8.0$ dB range. When this unit is shipped from the factory, the bass level is set to 0 dB. To trim the bass level, activate tone control by pressing the TONE button on either the unit or the remote controller.

1. Press the TRIM button once to access the LEVEL trimming mode.

```
L LEVEL R
  00  00
```

2. Press the ENTER button once to access the BASS trimming mode.

```
L BASS R
  0    0
```

3. The flashing "0" on the left indicates that trimming is activated for the left channel bass level. Press the ▲ and ▼ buttons to set the bass level of the left channel.

```
L BASS R
+6    0
```

4. Press the ► button to start the "0" on the right side flashing. When the right side "0" starts flashing, trimming is activated for the right channel bass level. Press the ▲ and ▼ buttons to set the bass level of the right channel.

```
L BASS R
+6   +6
```

5. To trim the bass level of the ID 2 (slave) unit, press the TRIM button again and set the bass level as in steps 2-4. After that, pressing the TRIM button again allows you to trim the bass level for the "ID 3" unit and so forth.
6. When finished with bass level trimming, press the EXIT button.

■ How to Trim Treble

The treble level of the left and right channels can be trimmed in 2dB steps across a $-8.0 - +8.0$ dB range. When this unit is shipped from the factory, the bass level is set to 0 dB. To trim the treble level, activate tone control by pressing the TONE button on either the unit or the remote controller.

1. Press the TRIM button once to access the LEVEL trimming mode.

```
L LEVEL R
  00  00
```

2. Press the ENTER button twice to access the TREBLE trimming mode.

```
L TREBL R
  0    0
```

3. The flashing "0" on the left indicates that trimming is activated for the left channel treble level. Press the ▲ and ▼ buttons to set the treble level of the left channel.

```
L TREBL R
+6    0
```

4. Press the ► button to start the "0" on the right side flashing. When the right side "0" starts flashing, trimming is activated for the right channel treble level. Press the ▲ and ▼ buttons to set the treble level of the right channel.

```
L TREBL R
+6   +6
```

5. To trim the treble level of the ID 2 (slave) unit, press the TRIM button again and set the treble level as in steps 2-4. After that, pressing the TRIM button again allows you to trim the treble level for the "ID 3" unit and so forth.
6. When finished with treble level trimming, press the EXIT button.

HOW TO USE AND SET FEATURES

HOW TO OPERATE THE SIDE ILLUMINATION

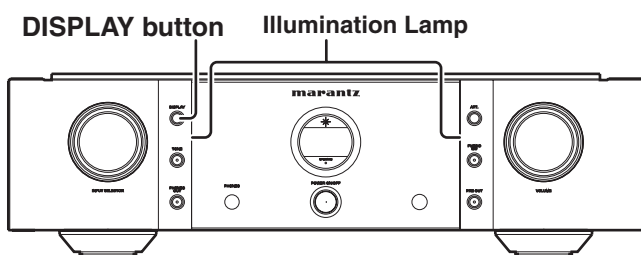

The illumination lamp has an always-ON mode (factory setting) and an always-OFF mode.

In the always-ON mode, the illumination lamp turns ON/OFF in sync with the display.

1. With the illumination lamp lit, press and hold the DISPLAY button for 3 seconds or longer. The illumination lamp goes out, and the always-OFF mode is engaged.
2. To cancel the always-OFF mode and turn the illumination lamp ON, press and hold the DISPLAY button for 3 seconds or longer.

BI-AMP MODE

This unit is equipped with a bi-amp mode to enable a complete bi-amp connection using two SC-11S1s. This complete bi-amp connection is a high-end technique for enhancing sound quality, proposed by Marantz. Using this system, the bi-amp supporting speaker system is separated from the preamplifiers that separately drive the low and high speakers. (For more information, see **Connection Example 2** (page.14).)

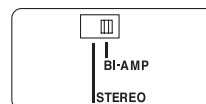

The bi-amp mode is engaged by setting the operating mode switch on the rear panel to "BI-AMP". In the bi-amp mode, the signals input to the L channel are split by the input selector and sent to the left and right volume amplifiers, and are then output to the PRE OUT terminals. The figures below show example displays in the stereo and bi-amp modes.

Stereo mode	Bi-amp mode
LINE-1 -40.0	LINE-1 * -40.0

Notes:

- When in bi-amp mode, the R channel input jacks cannot be used.
- When in bi-amp mode, the signals input into the L channel are output from both channels. Therefore, the same signals are output from the L channel and R channel in RECORDER OUT, PRE OUT, PHONES OUT.
- Always turn the power to the unit OFF before changing the operating mode switch setting. Turning the power ON again activates the new setting.

HOW TO USE AND SET FEATURES

REMOTE POWER CONTROL

By connecting this unit to a Marantz SM-11S1 stereo power amplifier by remote power control, the power supply of the SM-11S1 can be automatically switched ON/OFF in sync with this unit's power ON/OFF control. There are 2 trigger output terminals on this unit, and a maximum of 2 SM-11S1s can be controlled in sync with this unit's power ON/OFF control.

1. Prepare the correct number of double-ended mini plug audio connection cables for the number of SM-11S1s to be connected. Either of the following types of connection cables are adequate.
 - Monaural miniplug ⇔ monaural miniplug connecting cable

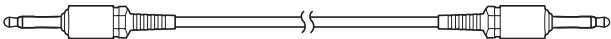

- Stereo miniplug ⇔ stereo miniplug connecting cable

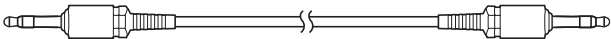

Note:

Do not use connecting cables that contain resistance.

2. After completing the connections shown below, switch the remote power control ON/OFF switch on the rear panel of the SM-11S1 to ON.
3. Press the SM-11S1 POWER ON/OFF switch to switch to standby mode.
4. In this condition, press the POWER ON/OFF switch on this unit, and the power of the SM-11S1 will switch ON in sync.

Notes:

- The SM-11S1 cannot be controlled if the SM-11S1 remote power control switch is OFF.
- When the power for this unit is switched ON or OFF, control sync signals are output from TRIGGER OUT 1 and 2. (However, the TRIGGER OUT 2 power ON control signal is output approximately 1 second after the TRIGGER OUT 1 power On control signal output.)

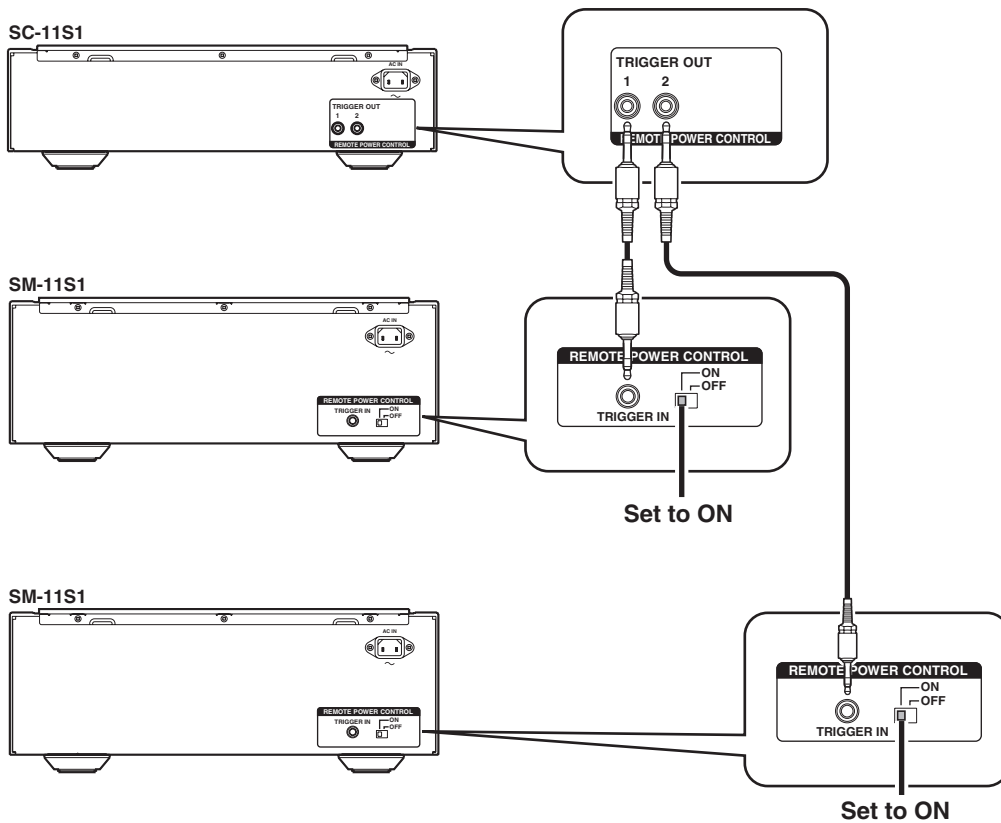

HOW TO USE AND SET FEATURES

F.C.B.S.

F.C.B.S. (Floating Control Bus System) is a communication system that connects up to four SC-11S1s over a dedicated bus line so as to enable synchronized operations amongst them via 2-way data communications.

Prepare the correct number of portable audio connection cables for the number of units to be connected. Either of the following types of connection cables are adequate.

- Monaural miniplug ⇔ monaural miniplug connecting cable

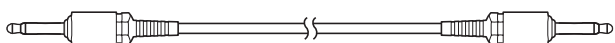

- Stereo miniplug ⇔ stereo miniplug connecting cable

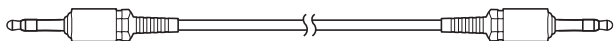

Note:

Do not use connecting cables that contain resistance.

The figure below shows an example of four SC-11S1s connected by F.C.B.S. The top unit is the master unit with ID 1 and controls the three slave units with ID 2~4. When the master unit is operated, the input source, volume level, ATT feature, display and tone control ON/OFF feature of the slave units are operated in sync with the master unit.

This function can be applied to various usages such as complete bi-amp with 2 SC-11S1s (page. 14), and 5.1ch multi-channel with 3 SC-11S1s (page. 16).

Note:

The SC-11S1 F.C.B.S. function is only valid between the same SC-11S1 models. This function may not operate correctly if other Marantz models (PM-11S1, PM-15S1 etc) are connected.

To turn the power of multiple F.C.B.S.-connected units ON/OFF, switch the power ON in order of lowest to highest ID number, and switch the power OFF in order of highest to lowest ID number.

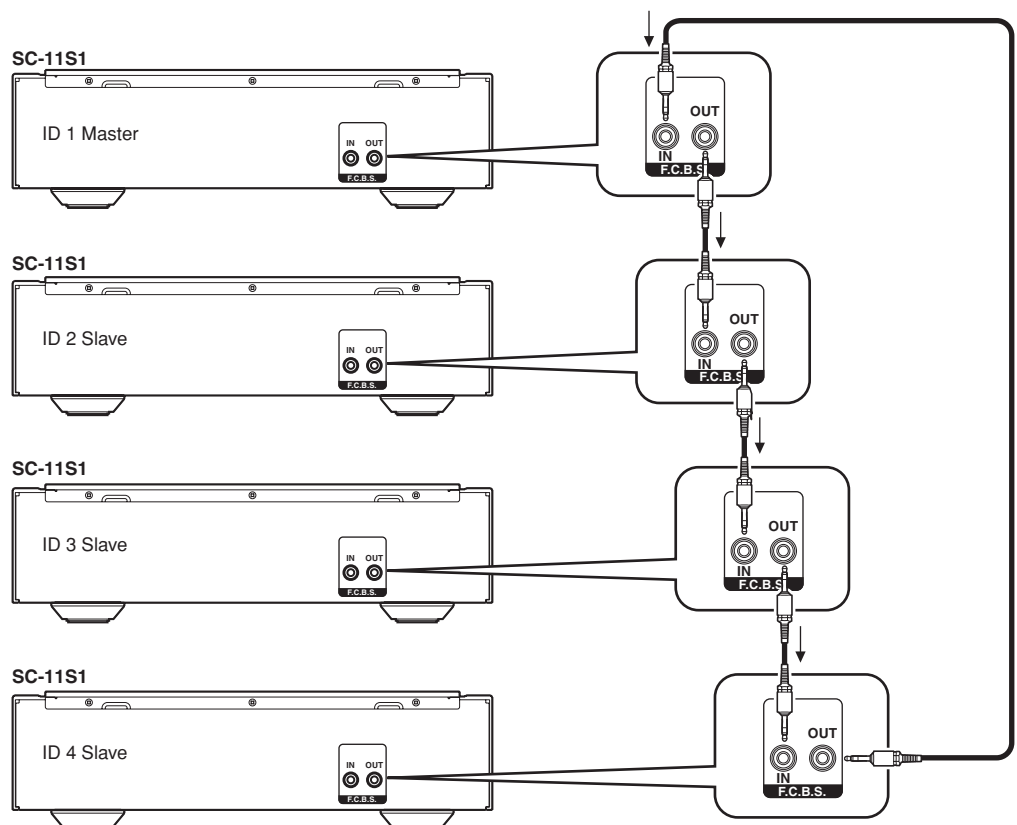

HOW TO USE AND SET FEATURES

HOW TO SET ID NUMBERS

If using this unit by itself as a stereo amplifier, set the ID number to "0" (Default setting is "0").

Note:

If the ID number is set to a number other than "0", this unit cannot be used for standalone operation.

The ID number of the unit appears on the display for about 3 seconds after the power is activated.



When multiple SC-11S1s are connected, a unique ID number must be set of each one in order to distinguish between them.

The unit that centrally controls the other units takes ID 1. The unit with ID1 is called the "Master". The other units that synchronize with the master are called "slaves" and take IDs "2" ~ "4".

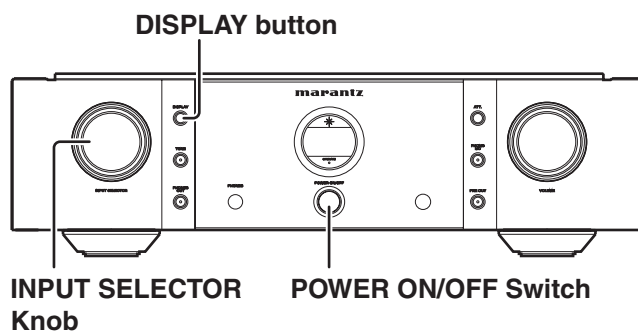

Set ID numbers as follows.

1. While pressing and holding the DISPLAY button, press the POWER ON/OFF switch.



2. Turn the INPUT SELECTOR knob to the desired ID number.



After finishing setting the ID number, turn power to the unit OFF.

The setting is stored in memory and becomes active the next time power to the unit is switched ON.

TROUBLESHOOTING

If you experience trouble with the SC-11S1, make the below checks before thinking the worst. Improper operation can cause the SC-11S1 to behave in a way that makes you think something is wrong with the equipment when actually not. If the trouble cannot be fixed after making the below checks, contact the place of purchase, your nearest Marantz dealer, our customer service center or our repair service center.

● Power does not turn ON

Is the power cable securely plugged into a power outlet?

● Nothing is heard from the headphones or speakers

1. Is the PRE OUT button on the front panel OFF?
2. Is the PHONES OUT button on the front panel OFF?
3. Is the ATT (attenuation) feature active?
4. Is the input source selected with the INPUT SELECTOR on the front panel correct?
5. Are you using the player (replaying device) correctly?
6. Are connection cables and speaker cables securely connected?
7. Volume may have been muted by a protective circuit that tripped. Try adjusted the volume again.
8. If an error message is displayed, correctly set the ID number as indicated in the reference table.

● Volume differs between left and right

Are the volume (LEVEL TRIM), bass, or treble levels trimmed differently for the right and left sides? If required, try trimming again.

● Sound is not stereo

The MODE switch on the rear panel may be set to "BI-AMP". If the unit is in bi-amp mode, shut the power OFF, set the MODE switch to "STEREO" and then reactivate the power. Power must be activated after the MODE switch is set for the setting to be active.

● Record player audio is not heard or contains a lot of noise

1. Is the PHONO MC button on the front panel set to match the type of cartridge you are using?
2. Are the connection cables securely connected?
3. Is the grounding wire from the record player connected to the PHONO GND terminal?
4. Is the cartridge properly connected to the tone arm?

■ Protective Circuits

The unit is equipped with protective circuits to protect the amplifier circuits and headphones against damage. If a protective circuit trips, the sound is instantly muted. In this case, "PROTECT" flashes on the display and the OPERATE indicator also flashes. To release the protective circuits, switch the power OFF, and wait for approximately 1 minute before switching the power back ON again.

● At Power ON

For about 8 seconds after the power is switched ON, a protective circuit trips and mutes the sound to give amplifier circuits time to stabilize. Once the amplifier circuits stabilize, the protective circuit releases and audio is enabled.

● If Strong Bass Signals Are Input

A protective circuit trips if bass signals of an excessive level are detected. A protective circuit also trips if an abnormality caused by such reasons as an amplifier fault is detected in the power supply circuit.

■ Error Messages

When multiple SC-11S1s are connected by F.C.B.S., the below error messages may appear on the display. In these cases, there is a problem with the ID number setting or remote cable connection. Check the ID numbers and remote cable as indicated in the below table. For details on how to set ID numbers, see **HOW TO SET ID NUMBERS** on pg. 27.

	Error message	Meaning	What to do
1	ERROR 02	ID 2 is used with more than one amp.	Set separate ID numbers for each amp.
2	ERROR 03	ID 3 is used with more than one amp.	
3	ERROR 04	ID 4 is used with more than one amp.	
4	ERROR 11	Amps of IDs 2 - 4 cannot communicate with ID 1 amp.	If power to ID 1 amp is OFF, activate power. Check remote cable is properly connected.
5	ERROR 12	ID 1 amp cannot communicate with amps of IDs 2 - 4.	If ID 1 is used for more than one amp, properly set ID numbers. Check remote cable is properly connected.

SPECIFICATIONS & DIMENSIONAL DRAWINGS

- Power output (20Hz – 20kHz)
 -2.0V (BALANCED)
 - 2.0V (UNBALANCED)
- Maximum output (20Hz – 20kHz)
 -13.5V (BALANCED)
 - 13.5V (UNBALANCED)
- Total frequency distortion (20Hz – 20kHz)
 -0.002% (BALANCED)
 -0.003% (UNBALANCED)
- Frequency response (±3dB)
 - 5Hz – 120kHz (BALANCED)
 - 5Hz – 120kHz (UNBALANCED)
- Input sensitivity/Input impedance
 - PHONO (MC).....280µV / 100Ω
 - PHONO (MM)2.9mV / 47kΩ
 - BALANCED250mV / 20kΩ
 - CD/LINE/RECORDER.....250mV / 20kΩ
- S/N rate (IHF A network, 0.5V output)
 - PHONO (MC).....78dB (0.5mV input)
 - PHONO (MM)89dB (5mV input)
 - BALANCED98dB (500mV input)
 - CD/LINE/RECORDER.....99dB (500mV input)
- Tone control
 - BASS (50Hz) ±8.0dB
 - TREBLE (20kHz) ±8.0dB
- Maximum allowed PHONO input (1kHz)
 - MC 15mV
 - MM..... 150mV
- Headphone maximum output (20Hz – 20kHz)
 - 200mW + 200mW (32Ω load)
 - 400mW + 400mW (600Ω load)
- Headphone total frequency distortion (20Hz – 20kHz)
 -0.015%
- Headphone frequency response (±3dB) 5Hz – 100kHz
- Power requirement
 -AC 120V 60Hz (U.S.A.)
 - AC 230V 50/60Hz (Europe)
- Power consumption 35W (EN60065) (UL60065)
- Maximum outer dimensions
 - Width.....440mm (17-3/8 ins.)
 - Height127mm (5 ins.)
 - Depth431mm (17 ins.)
- Weight 16.0kg (35.3 lbs)

● Dimensions (Unit: mm (inch))

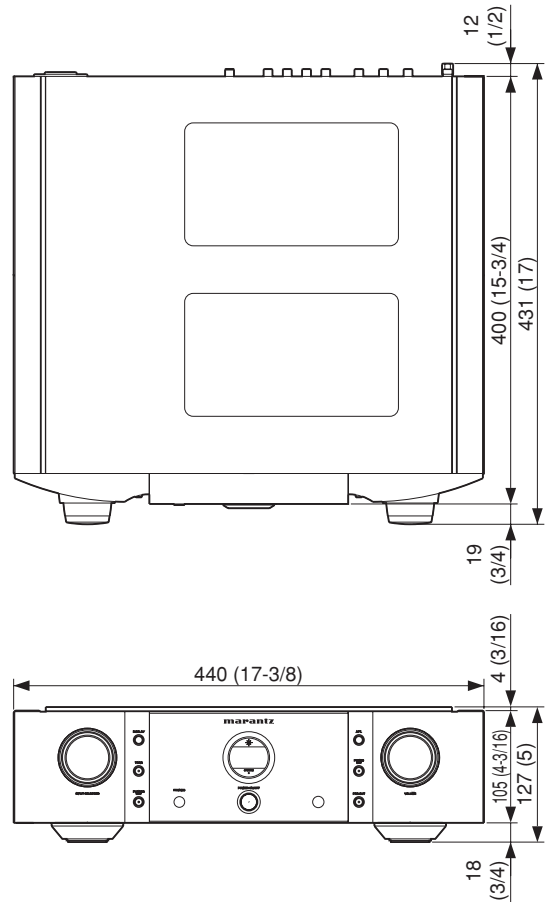

Specifications subject to change without prior notice.

Accessories

- Remote controller 1
- Size “AAA” batteries.....2
- AC Power cord..... 1
- User Guide..... 1
- Warranty Card (U.S.A.) 1
- Warranty Card (Canada)..... 1

OTHERS

The section describes the care and maintenance tasks that must be performed to optimize the operation of your Marantz equipment.

■ Cleaning of equipment external surfaces

The exterior finish of your unit will last indefinitely with proper care and cleaning. Never use scouring pads, steel wool, scouring powders or harsh chemical agents (e.g., lye solution), alcohol, thinner, benzine, insecticide or other volatile substances as these will mar the finish of the equipment. Likewise, never use cloths containing chemical substances. If the equipment get dirty, wipe the external surfaces with a soft, lint-free cloth.

If the equipment becomes heavily soiled:

- dilute some washing up liquid in water, in a ratio of one part detergent to six parts water.
- dip a soft, lint free in the solution and wring the it is damp.
- wipe the equipment with the damp cloth.
- dry the equipment by wiping it with a dry cloth.



■ Repairs

Only the most competent and qualified service technicians should be allowed to service the factory-trained warranty station personnel have the knowledge and special facilities needed for repair and calibration of this precision equipment. After the warranty period has expired, repairs will be performed for a charge if the equipment can be returned to normal operation.

In the event of difficulty, refer to your dealer or write directly to the nearest location to you that is listed on the Marantz Authorized Service Station list. If writing, please include the model and serial number of the equipment together with a full description of what you think is abnormal about the equipment's behaviour.

www.marantz.com

You can find your nearest authorized distributor or dealer on our website.

marantz[®] is a registered trademark.