

marantz®

Model RC2001 User Guide

Remote Controller

The logo for Wizz.2 features the word "Wizz.2" in a bold, italicized, sans-serif font. Above the "z" in "Wizz" are four curved lines of increasing length, resembling a signal or sound wave.

NOTE:

This equipment has been tested and found to comply with the limits for a Class B digital device, pursuant to Part 15 of the FCC Rules. These limits are designed to provide reasonable protection against harmful interference in a residential installation. This equipment generates, uses and can radiate radio frequency energy and, if not installed and used in accordance with the instructions, may cause harmful interference to radio communications. However, there is no guarantee that interference will not occur in a particular installation. If this equipment does cause harmful interference to radio or television reception, which can be determined by turning the equipment off and on, the user is encouraged to try to correct the interference by one or more of the following measures:

- Reorient or relocate the receiving antenna.
- Increase the separation between the equipment and receiver.
- Connect the equipment into an outlet on a circuit different from that to which the receiver is connected.
- Consult the dealer or an experienced radio/TV technician for help.

NOTE:

Changes or modifications may cause this unit to fail to comply with Part 15 of the FCC Rules and may void the user's authority to operate the equipment.

This Class B digital apparatus complies with Canadian ICES-003.

Cet appareil numérique de la Classe B est conforme à la norme NMB-003 du Canada.

DECLARATION OF CONFORMITY

This device complies with Part 15 of the FCC rules. Operation is subject to the following conditions: (1) This device may not cause harmful interference, and (2) this device must accept any interference received, including interference that may cause undesired operation.

U.S. Responsible Party: Marantz America, Inc. 100 Corporate Drive, Mahwah, NJ, 07430, U.S.A. TEL: 630-741-0300

Type of Product: Remote controller
Model: RC2001

RC_071003U4

Thank you for purchasing the Marantz RC2001 remote controller.

This remarkable component has been engineered to provide you with many years of home theater enjoyment. Please take a few minutes to read this manual thoroughly before you operate the RC2001.

CHECKING THE ACCESSORIES

After opening the cover of the packing box, check that the following accessories are included.

- RC2001: Remote controller
- AAA type alkaline batteries x 4
- USB cable
- User guide

FEATURES

RC2001 : Remote controller



- Versatile Learning Capability with 4Mbit (512KB) User Memory (Max 1000 codes)
- Backlit Hard Buttons and LCD Display
- Programmable One Button Operation via “Multi Command” Macros (Max. Total 8000 Steps).
- Multiple Page Creation Capability
- Customize RC2001 by Using  Software
- Built-in Multi Brand Database via  Software
- Advanced Timer Function
- IR Transmission

TABLE OF CONTENTS

BEFORE USE..... 2
 LOADING BATTERIES.....2
 USING THE REMOTE CONTROLLER WITH INFRARED RAYS.....3
NAMES AND FUNCTIONS..... 4
 REMOTE CONTROLLER4
 REMOTE CONTROLLER LCD5
BASIC OPERATION..... 6
 RC2001 BUTTON SETTINGS6
 SLEEP TIMER6
OTHER OPERATION 7
 MAIN MENU7
 1. LEARNING FUNCTION7
 2. TIMER9
 3. SYS.SETUP..... 12
 4. STATUS INDICATOR 17
 5. RESET 17
 6. PROGRAMMABLE CODES..... 17
 SPECIFICATIONS 18
 OTHERS 19

BEFORE USE

LOADING BATTERIES

Before using the remote controller for the first time, load the batteries in the remote controller. The batteries provided are used to verify the operations of the remote controller only.

Note:

The settings remain saved in the remote controller even if the power completely runs out. However, the time setting will be lost, and so please set the time setting again.

1. Remove the battery case cover.

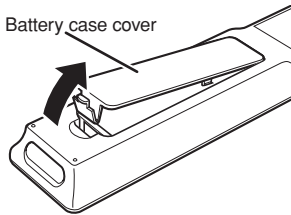

2. Insert the new batteries (AAA type) with correct \oplus and \ominus polarity.

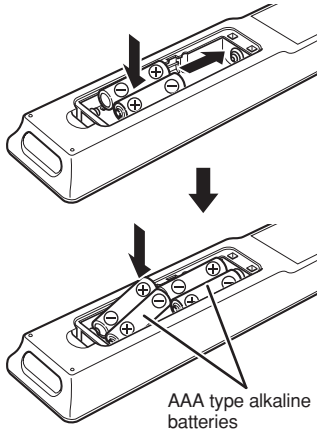

3. Attach the battery case cover.

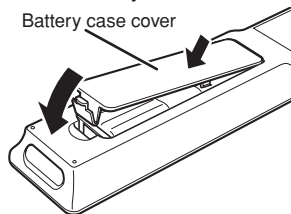

CAUTION ON BATTERY

- Use “AAA” type batteries in this remote controller.
- We recommend that you use alkaline batteries.
- If the remote controller does not operate from close to the main unit, replace the batteries with new ones, even if less than a year has passed.
- The included battery is only for verifying operation. Replace it with a new battery as soon as possible.
- When inserting the batteries, be careful to do so in the proper direction, following the + and - marks in the remote controller’s battery compartment.
- To prevent damage or battery fluid leakage:
 - Do not use a new battery with an old one.
 - Do not use two different types of batteries.
 - Do not short-circuit, disassemble, heat or dispose of batteries in flames.
- Remove the batteries when not planning to use the remote controller for a long period of time.
- If the batteries should leak, carefully wipe off the fluid from the inside of the battery compartment, then insert new batteries.
- When disposing of used batteries, please comply with governmental regulations or environmental public instruction’s rules that apply in your country or area.

USING THE REMOTE CONTROLLER WITH INFRARED RAYS

The remote controller uses infrared (IR) signals to operate devices.

This means that you have to point the IR sending eye of the remote controller towards the devices you are operating.

Operate the device with the remote controller within the range of the illustration below.

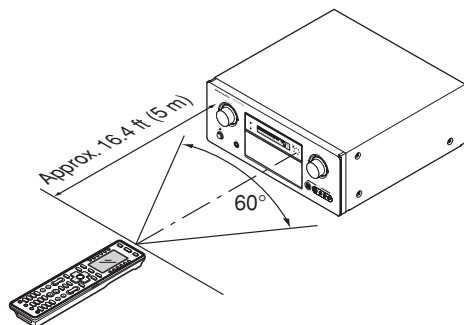

Precautions:

- Do not allow direct sunlight, an inverter fluorescent light or other strong source of light to shine onto the player's infrared signal reception window (remote sensor). Otherwise, the operation of the remote controller may be disabled.
- Bear in mind that operating the remote controller may cause other devices operated by infrared rays to be operated by mistake.
- The remote controller cannot be operated if the space between the remote controller and the device's remote sensor is obstructed.
- Do not place any objects on top of the remote controller. Doing so may cause one or more buttons to be held down which will cause the batteries to run down.

NAMES AND FUNCTIONS

REMOTE CONTROLLER

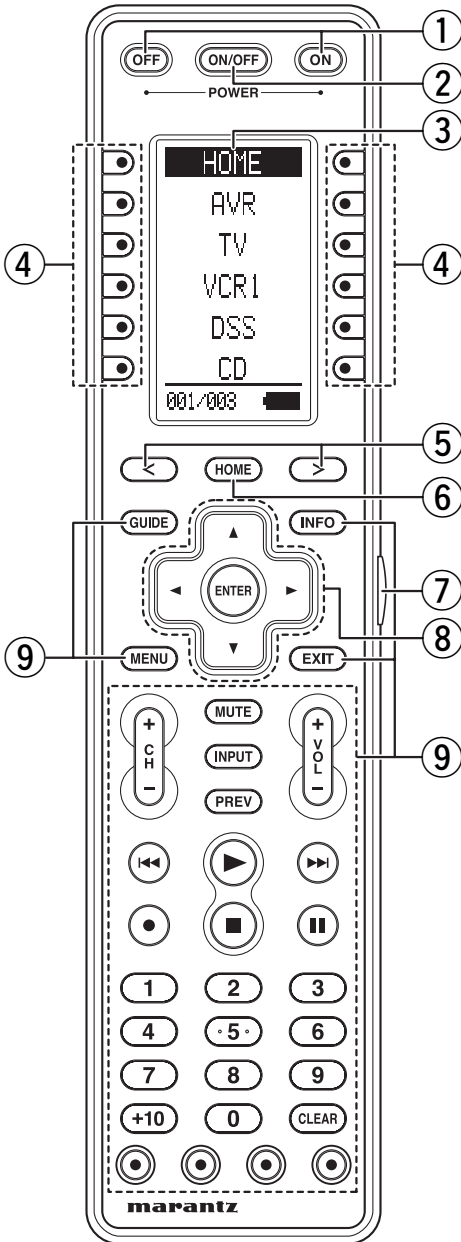

① POWER ON and OFF buttons

These buttons are used when controlling devices that have been set with separately powered on and off remote commands.

② SOURCE ON/OFF button

This button is used when controlling devices that have been set with a single power on/off remote command.

③ LCD Display

Remote controller display

④ Programmable soft buttons

These buttons are used by the Wizz.it 3 editor software to make LCD display and button operation settings.

These buttons are also used to adjust the number of pages for each device.

⑤ Page Scroll buttons

These buttons are used when scrolling pages in Home mode and the device modes.

⑥ Home button

This button is used to select Home mode.

To select a device that will be controlled, first select Home mode, then select the device.

⑦ Light button

This button is used to turn on the backlight for the buttons and LCD.

⑧ Cursor, ENTER buttons

⑨ Programmable Hard buttons

These buttons are used by the Wizz.it 3 editor software to make the remote controller command settings for learning and macro operations.

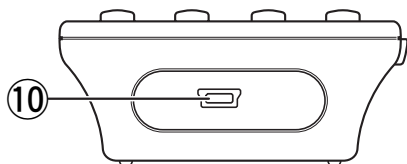

⑩ USB port

This port is used to connect the remote controller and a PC with the supplied USB cable to enable editing with the Wizz.it 3 editor software.

REMOTE CONTROLLER LCD

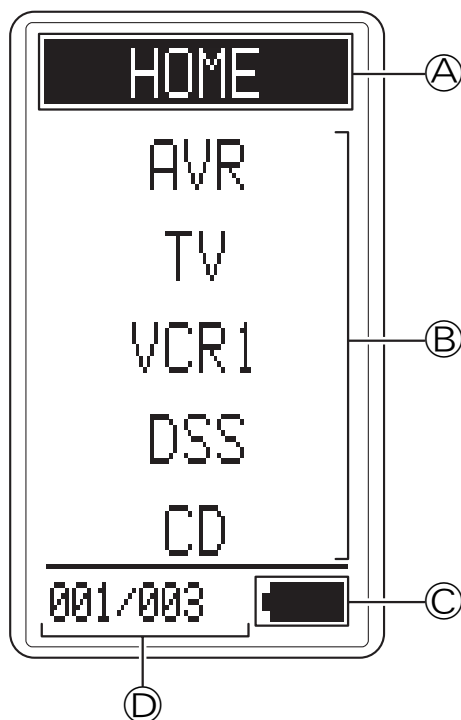

Ⓐ Mode display area

Home:

This is displayed during Home mode.

Device Name:

This displays the device mode name that is currently active.

This area is always highlighted.

Ⓑ Command display area

This displays the information that has been set for the display items in the device modes.

Ⓒ Battery indicator

This displays the remaining battery power.

Ⓓ Sub info. Area

Normal operation:

The page number that has been set for the respective mode is displayed.

When sending IR command:

The command name that has been set for the respective button is highlighted.

Operation when not sending an IR command (such as jump operation):

The operation name that has been set for the button is displayed normally (not highlighted).

BASIC OPERATION

RC2001 BUTTON SETTINGS

The Wizz.it 3 editor software can be used to make the settings for the IR Command, LINK, JUMP, One Touch Operation (Macro) and other functions in the RC2001.

This enables a customized user interface, optimized for the customer's environment, to be built.

The Wizz.it 3 editor software can be downloaded from www.marantz.com. For more information about the setting procedures, see the PC Editor Software Wizz.it 3 User Guide.

This is the basic operation procedure for the RC2001.

1. Press the Home button to enter Home mode for the RC2001.
2. Select the devices that are set in Home mode.
3. Perform operation of the device that you want to control in the selected device mode.
4. To control another device, return to Home mode and select another device.

The preinstalled default user file is used to control Marantz products. The AV receiver device input switching code is assigned to the button next to the displayed device name of the device mode.

Example:

After DVD mode is selected in the remote controller, pressing the button next to DVD, shown in the first column in the LCD, transmits the AV receiver DVD input command.

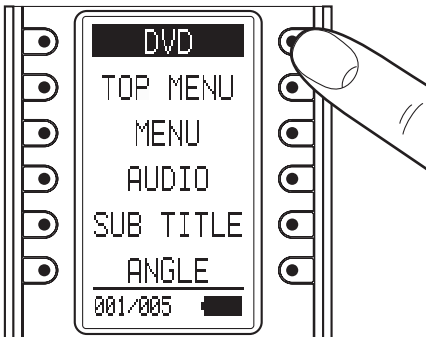

DVD input command for Marantz AV Receiver.

SLEEP TIMER

The SLEEP TIMER is a function that sends a preset remote command after the sleep time has elapsed.

- The setting is made using the Wizz.it 3 editor, and the buttons that are assigned to the sleep timer are operated as shown below.
- This is a convenient function for devices that do not have a sleep timer or for setting the sleep timer using multiple devices.
- The RC2001 performs regular operation even when the sleep timer is activated.

1. Press the button that will be assigned to the sleep timer. The message "PROCEED?" is displayed on the LCD.

2. Each time the button is pressed, the sleep setting time changes in the cycle shown below.

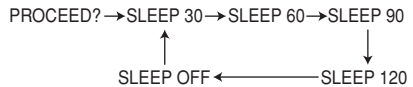

3. When the time that you want to set is displayed, wait at the setting for three seconds.

- The sleep setting screen is no longer displayed on the LCD, and the sleep timer is automatically started.

And the sleep timer icon is displayed in Sub Info area of the LCD.

- When the remaining time for the sleep timer setting is 10 minutes, the remaining time is displayed in the Sub info. area of the LCD.

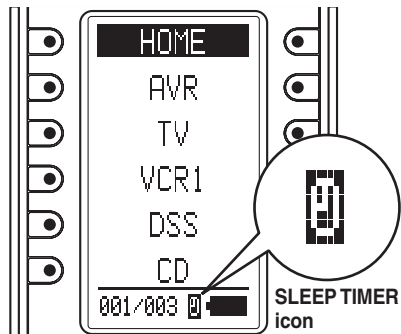

OTHER OPERATION

MAIN MENU

The various settings for the remote device are made in the main menu.

ENTERING THE MAIN MENU

1. Press the Home button to enter Home mode for the RC2001.
2. Hold down the Home button and Menu button at the same time for three seconds to display MAIN MENU on the LCD.

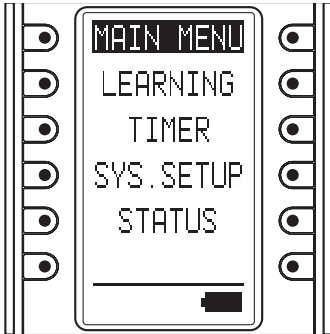

1. LEARNING FUNCTION

1. Place the remote controller so that its infrared signal transmitter is facing the infrared signal receiver on the Marantz remote controller at a distance of about 2 inches (0.05 m).

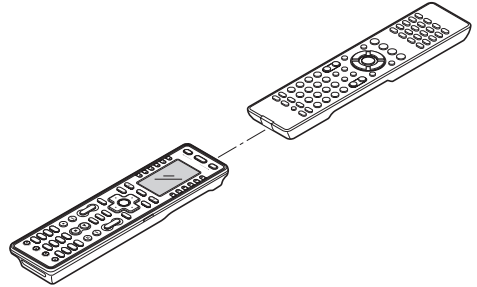

2. Display the MAIN MENU on the LCD of the RC2001, and then press the button next to the "LEARNING" indicator.

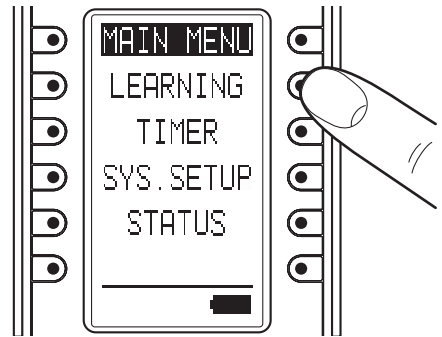

3. The screen appears as shown below. Either press the ENTER button or wait for three seconds.

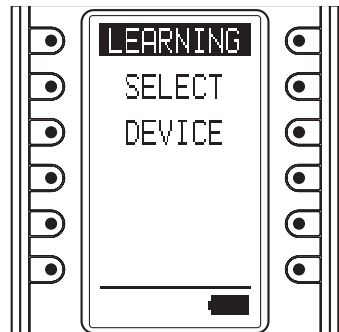

4. This screen changes to HOME mode. Press the button next to the displayed device name whose commands you want to learn.

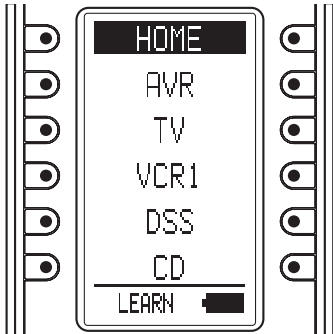

Note:

In Home mode, learning cannot be performed with the SOFT button using the procedure shown below. Use the Wizz.it 3 editor to make any changes.

5. After selecting the device name, press the button whose command you want to learn.

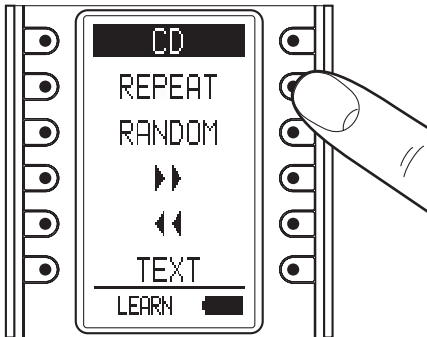

6. This enters the learning standby mode. Send the remote controller code that you want to learn.

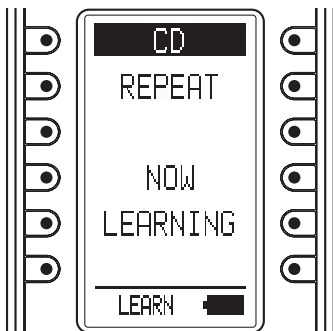

7. The remote controller has completed learning when "LEARN OK" is displayed on the LCD.

- Pressing the ENTER button enables you to continue learning commands for another button in the same device mode.
- When the learning mode is completed, press the Home button three times to return the LCD to the MAIN MENU.

Notes:

- If learning could not be performed, "LEARN ERROR" is displayed on the LCD. Try performing steps 5 to 6 again.

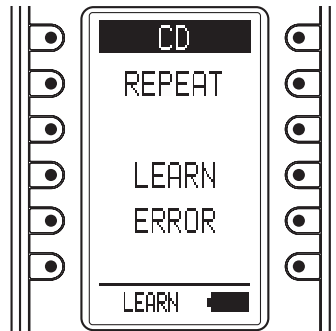

- When making the learning settings, the "LEARN ERROR" message may occasionally be displayed repeatedly on the LCD. In some cases, this can be due to transmission of a special remote controller signal code. Learning cannot be performed when a special remote controller signal code is used.
- The RC2001 can learn up to a maximum of 1,000 remote controller codes. Once 1,000 codes are programmed for learning, "LEARNFULL" is displayed on the LCD, and learning can no longer be performed.

To perform further learning, use the Wizz.it 3 editor to delete any unneeded learning codes.

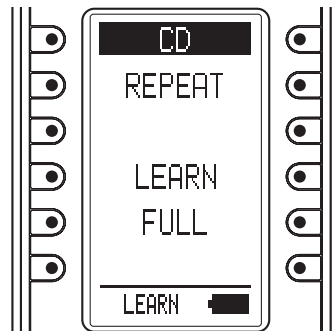

2. TIMER

The timer function of the RC2001 can be used to send a preset remote controller command at a programmed time.

The Wizz.it 3 editor can be used to operate multiple devices. One Touch Operation (Macro) can also use the timer function for transmission.

CHECKING THE SETTINGS

1. Display the MAIN MENU on the LCD of the RC2001, then press the button next to the "TIMER" indicator.
2. The TIMER menu is displayed. Pressing the button next to the "CHECK" indicator on the LCD displays the timer settings.

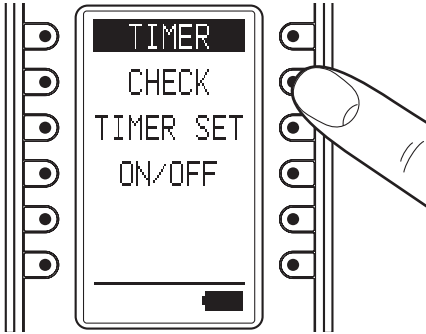

When the LCD appears as shown below, the timer has not been set.

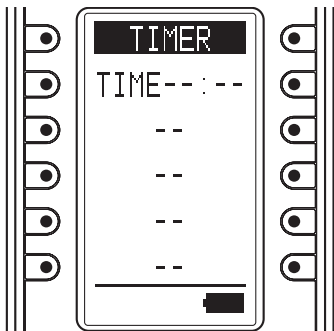

- Either press the ENTER button or wait three seconds for the LCD to automatically return to the TIMER menu.
- Pressing the Home button from the TIMER MENU screen returns the LCD to the MAIN MENU.

OPERATION SETTINGS

1. Press the button next to the "TIMER SET" indicator in the LCD in the TIMER menu screen to display the timer programming setting screen.

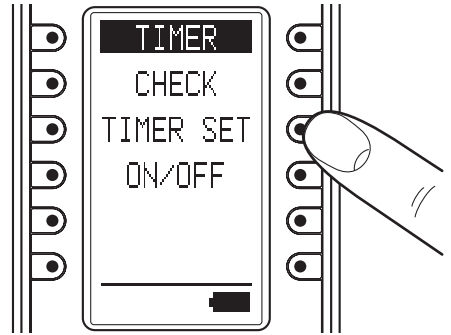

2. Use the numeric buttons (0 to 9) and cursor buttons (◀ and ▶) to set the time for the timer. After making the setting, press the ENTER button.

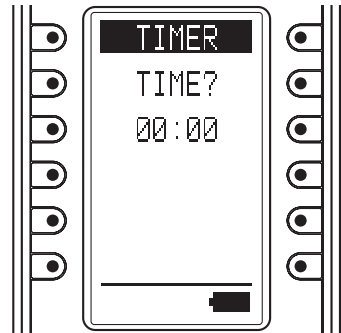

3. Home mode is shown in the LCD. Select the commands and devices for the commands that will be sent by timer programming.
- If a command assigned to the HARD button is to be sent by timer programming, press the HARD button when selecting the command to make the setting.
 - If a command assigned to the SOFT button is to be sent by timer programming, use the < and > buttons when selecting the command to move the page, and select the command assigned to the SOFT button.

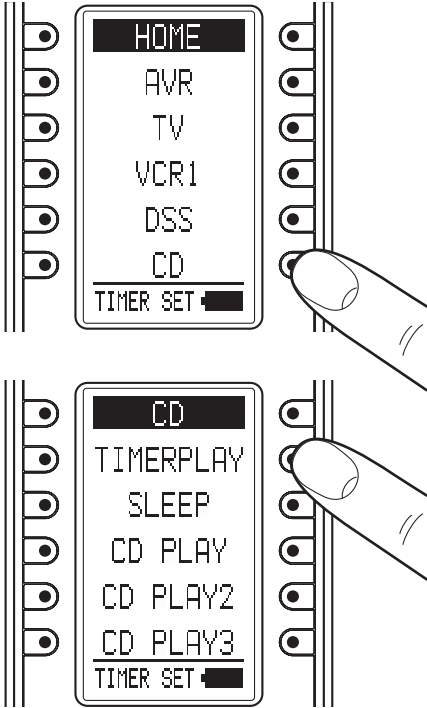

Note:

The timer setting for the SOFT button cannot be used in Home mode.

4. Press a button next to the “EVERYDAY” or “ONE TIME” indicators on the LCD to set timer operation to either everyday or one-time only operation.

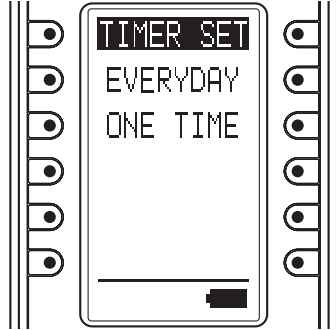

- The timer settings are displayed. Check that the settings are correct.

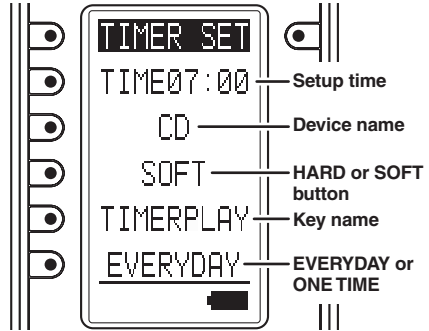

- Either press the ENTER button or wait three seconds so that “COMPLETED” is displayed on the LCD and the operation settings are automatically completed.

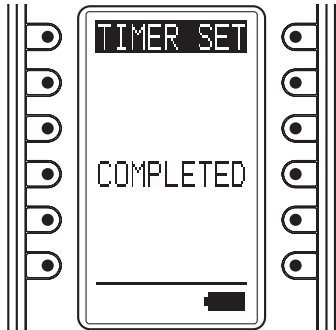

- Either press the ENTER button or wait three seconds for the LCD to automatically return to the MAIN menu.

OPERATION ON/OFF SETTINGS

1. Press the button next to the "ON/OFF" indicator in the TIMER menu screen on the LCD to display the timer operation ON/OFF setting screen.

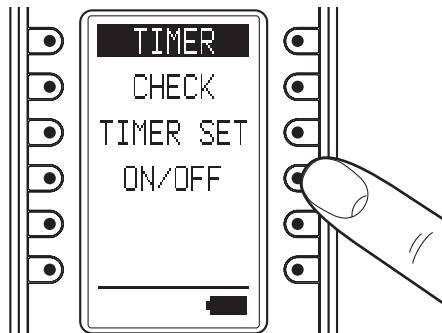

2. Press the button next to the "TIMER ON" (Enable) or "TIMER OFF" (Disable) indicators on the LCD to either enable or disable timer operation.

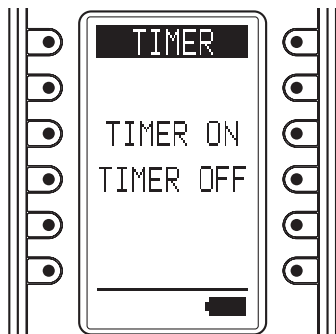

3. Either press the ENTER button or wait three seconds so that "COMPLETED" is displayed on the LCD and the operation settings are automatically completed.

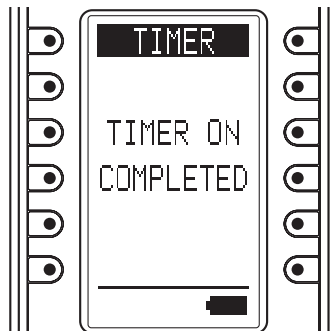

- Either press the ENTER button or wait three seconds for the LCD to automatically return to the MAIN menu.
- When timer operation is set to ON, the timer icon is displayed in the Sub Info area of the LCD.

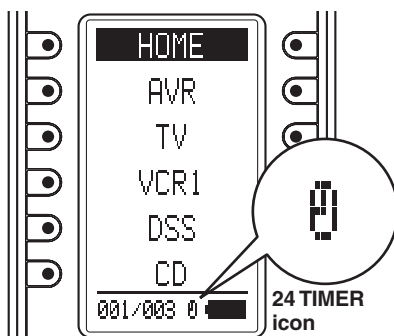

3. SYS.SETUP

Display the MAIN MENU on the LCD of the RC2001, then press the button next to the "SYS. SETUP" indicator.

The items below can be set in the SYS.SETUP screen.

- CLOCK (Clock setting)
- BACK LIGHT (Backlight illumination time setting)
- LCD (LCD setting)
- BEEP (Beep sound setting)
- MEM CLEAR (Initialization setting)

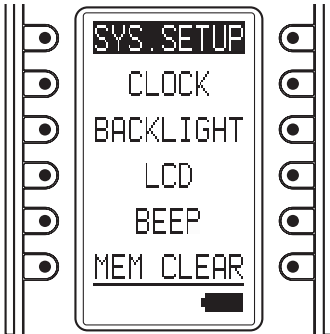

CLOCK (CLOCK SETTING)

This sets the clock for the RC2001.

1. Press the button next to the "CLOCK" indicator in the SYS.SETUP menu screen in the LCD to display the clock setting screen.

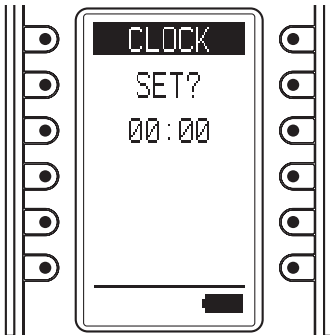

2. Use the numeric buttons (0 to 9) and cursor buttons (◀ and ▶) to set the current time. After setting the correct time, press the ENTER button.

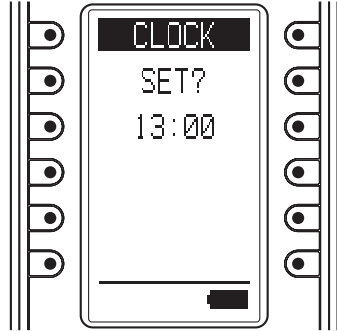

3. The message "COMPLETED" is displayed in the LCD to indicate that the clock setting is completed.

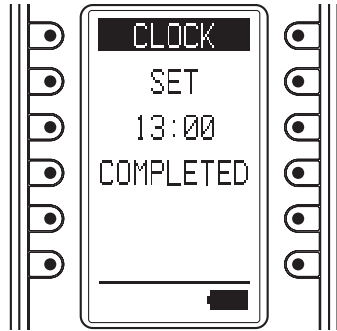

- Either press the ENTER button or wait three seconds for the LCD to automatically return to the SYS.SETUP menu.
- Pressing the Home button returns the LCD to the MAIN MENU.

Notes:

The clock can become out of sync over time. Please check it occasionally and set to the correct time if necessary.

The clock setting is not backed up when the batteries are replaced. Please reset the time after replacing the batteries.

BACKLIGHT(BACKLIGHTILLUMINATION TIME SETTING)

Press the LIGHT button on the RC2001 to turn on the backlight, then set the time until the backlight turns off.

1. Press the button next to the "BACKLIGHT" indicator in the SYS.SETUP menu screen in the LCD to display the backlight illumination time setting screen.

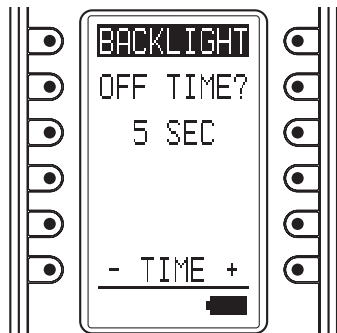

2. Press the buttons (right: +, left: -) displayed next to TIME to set the illumination time. The time can be set in 1-second intervals from 0 to 60 seconds.

After deciding the settings, press the ENTER button.

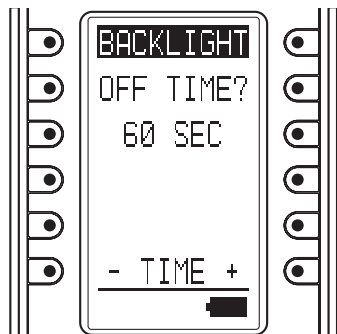

3. The message "COMPLETED" is displayed on the LCD to indicate that the illumination time setting is completed.

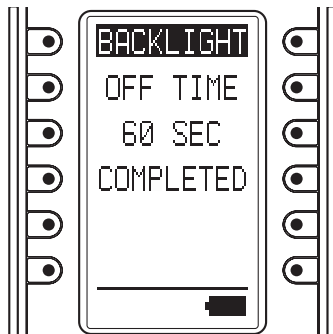

- Either press the ENTER button or wait three seconds for the LCD to automatically return to the SYS.SETUP menu.
- Pressing the Home button returns the LCD to the MAIN MENU.

Note:

Setting the BACK LIGHT TIMER to 0 sec is equivalent to turning off the backlight so that the backlight does not turn on even when the LIGHT button is pressed.

LCD (LCD SETTING)

Press the button next to the "LCD" indicator in the SYS.SETUP menu screen in the LCD. The LCD setting menu is displayed.

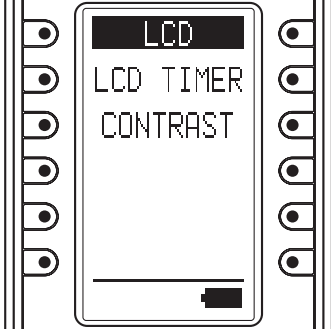

LCD TIMER (LCD timer setting)

This sets the time that the LCD remains on, after a button is pressed on the RC2001.

When there are no operations and the LCD is turned off, this setting enables power consumption to be reduced and the life of the batteries to be extended.

The default setting is 10 seconds.

1. The LCD setting menu is displayed, and so press the button next to "LCD TIMER" in the LCD display.
2. Press the buttons (right: +, left: -) displayed next to TIME to set the display time. The time can be set in 1-second intervals from 10 to 60 seconds.

To leave the LCD always on, press the button next to the "ALWAYS ON" indicator. However, please note that this setting will shorten the life of the batteries.

After deciding the settings, press the ENTER button.



3. The message "COMPLETED" is displayed on the LCD to indicate that the display time setting is completed.

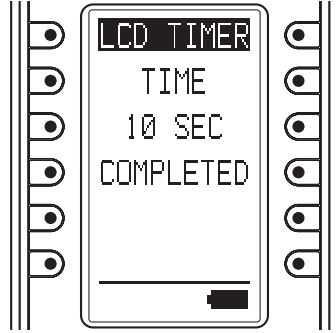

- Either press the ENTER button or wait three seconds for the LCD to automatically return to the SYS.SETUP menu.
- Pressing the Home button returns the LCD to the MAIN MENU.

Note:

If the LCD is turned off by the LCD timer, pressing any of the buttons on the remote controller will turn it on again. When the LCD is turned on, the pressed command is not activated.

To execute a command operation, press the button while the LCD is on.

CONTRAST (LCD CONTRAST ADJUSTMENT)

This enables the LCD contrast to be adjusted. Adjust for maximum visibility according to your viewing environment.

1. The LCD setting menu is displayed, and so press the buttons next to "CONTRAST" in the LCD display.
2. Press the side buttons (right: +, left: -) to adjust the contrast level.

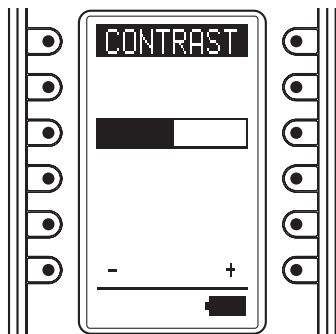

After deciding the settings, press the ENTER button.

The message "COMPLETED" is displayed on the LCD to indicate that the setting is completed.

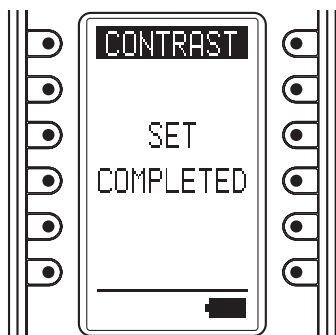

- Either press the ENTER button or wait three seconds for the LCD to automatically return to the SYS.SETUP menu.
- Pressing the Home button returns the LCD to the MAIN MENU.

BEEP (BEEP SOUND SETTING)

This sets the built-in beep sound in the RC2001.

1. Press the button next to the "BEEP" indicator in the SYS.SETUP menu screen in the LCD to display the beep setting screen.
2. Press the button next to the "ENABLE" or "DISABLE" indicators on the LCD to either enable or disable the beep sound.

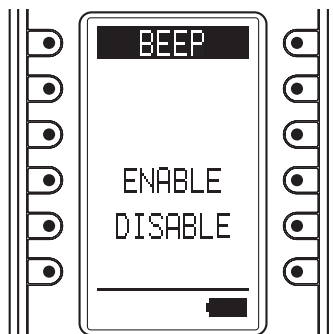

3. Either press the ENTER button or wait three seconds so that "ENABLE" or "DISABLE" is displayed on the LCD and the settings are automatically completed.

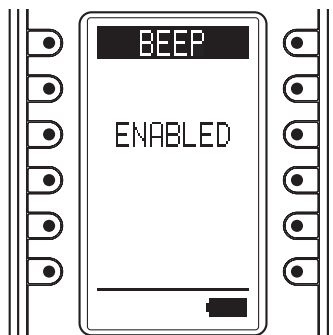

- Either press the ENTER button or wait three seconds for the LCD to automatically return to the SYS.SETUP menu.
- Pressing the Home button returns the LCD to the MAIN MENU.

MEM CLEAR (INITIALIZATION SETTING)

This returns the settings made in the RC2001 to their initial settings.

1. Press the button next to the “MEM CLEAR” indicator in the SYS.SETUP menu screen in the LCD to display the initialization setting screen.
2. Press the button next to the “NO” (Disable) or “YES” (Enable) indicators on the LCD to either enable or disable initialization.

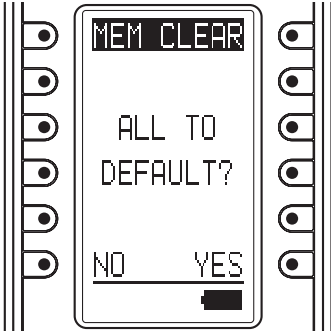

3. Pressing the NO button automatically returns the LCD to the SYS.SETUP menu. Pressing the YES button displays “COMPLETED” on the LCD and completes initialization.

The setting items that are initialized are shown below.

- TIMER SETUP
- BACK LIGHT TIMER
- LCD
- BEEP

Note:

The LEARNING and CLOCK settings are not initialized.

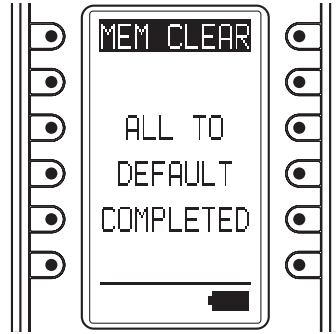

- Either press the ENTER button or wait three seconds for the LCD to automatically return to the SYS.SETUP menu.
- Pressing the Home button returns the LCD to the MAIN MENU.

4. STATUS INDICATOR

This displays the settings made in the MAIN MENU and the status of the remote device.

CHECKING THE STATUS

1. Display the MAIN MENU on the LCD of the RC2001, then press the button next to the "STATUS" indicator.
2. Pressing the ENTER button cycles through the statuses of each of the items below.
 - Remaining learning memory
 - Remaining macro steps
 - LCD timer setting
 - Backlight timer setting
 - Beep setting
 - Firmware version
 - Current clock time

Either press the ENTER button or wait three seconds so that the LCD returns to the MAIN MENU.

5. RESET

If the RC2001 is not operating properly, use the procedure below to perform a reset (restart). Performing a reset does not erase the settings in the RC2001.

1. Remove the battery case cover.
2. Use a paper clip or other object to press the reset button in the reset hole as shown in the figure below to reset the RC2001.

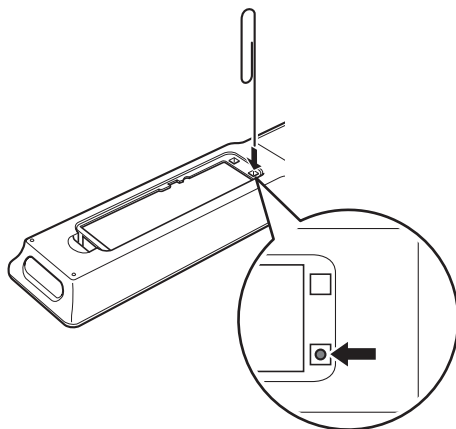

Note:

Perform the reset with the batteries loaded.

6. PROGRAMMABLE CODES

NUMBER OF PROGRAMMABLE CODES

This remote control has Flash memory 4M bit (512KB) that enables it to program remote control signals include the learned codes for up to 8000 codes.

This number is for Marantz remote control codes.

The actual number of codes may be less than 8000 depending on the type of the programmed remote control signals.

PROGRAMMABLE CODES

This remote control may be unable to learn the codes for some AV equipment due to the code types, system, or other differences.

SPECIFICATIONS

RC2001

- LCD Resolution“11x81pixel x6 line
9x81pixel x1line”
- Backlight EL backlight
- Transmission IR
- Learning..... Capability: MAX 1000code
- Operating/ learning IR frequency range
Up to 455kHz
- Interface
 .. USB 2.0 connection with USB bus power supply
- Memory Size..... 4M bit (512kB)
- Dimensions (W x H x L)
 54 x 228 x 25 mm (2-3/16 x 9 x 1 ins.)
- Unit Weight (With Batteries) 190g (0.4lbs)

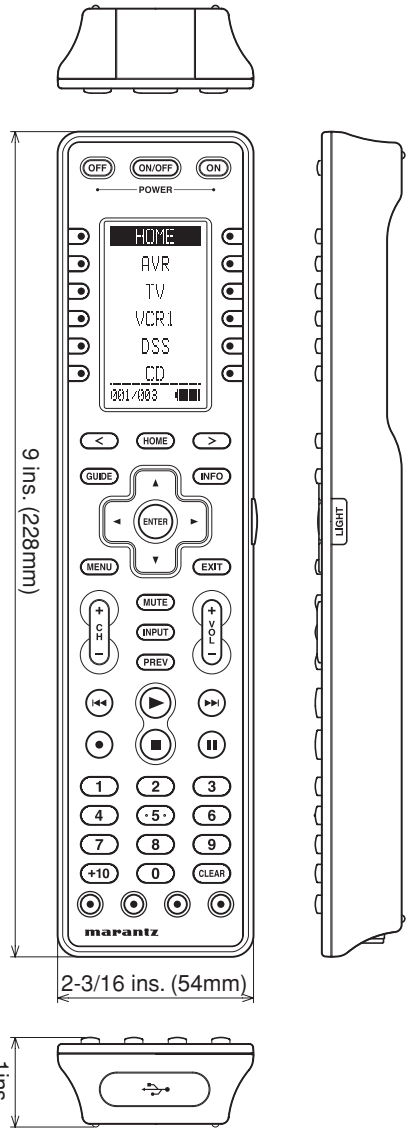

OTHERS

The section describes the care and maintenance tasks that must be performed to optimize the operation of your Marantz component.

CLEANING OF EQUIPMENT EXTERNAL SURFACES

The exterior finish of your unit will last indefinitely with proper care and cleaning. Never use scouring pads, steel wool, scouring powders or harsh chemical agents (e.g., lye solution), alcohol, thinner, benzine, insecticide or other volatile substances as these will mar the finish of the equipment. Likewise, never use cloths containing chemical substances. If the equipment get dirty, wipe the external surfaces with a soft, lint-free cloth.

If the equipment becomes heavily soiled:

- dilute some washing up liquid in water, in a ratio of one part detergent to six parts water.
- dip a soft, lint free in the solution and wring the it is damp.
- wipe the equipment with the damp cloth.
- dry the equipment by wiping it with a dry cloth.



REPAIRS

Only the most competent and qualified service technicians should be allowed to service the factory-trained warranty station personnel have the knowledge and special facilities needed for repair and calibration of this precision equipment. After the warranty period has expired, repairs will be performed for a charge if the equipment can be returned to normal operation.

In the event of difficulty, refer to your dealer or write directly to the nearest location to you that is listed on the Marantz Authorized Service Station list. If writing, please include the model and serial number of the equipment together with a full description of what you think is abnormal about the equipment's behaviour.

www.marantz.com

You can find your nearest authorized distributor or dealer on our website.

marantz[®] is a registered trademark.