

marantz®

Integrated Amplifier **PM8005**

You can print more than one page of a PDF onto a single sheet of paper.

[Front panel](#)[Rear panel](#)[Remote](#)[Index](#)

Owner's Manual

Contents

Accessories	4
Inserting the batteries.....	5
Operating range of the remote control unit.....	5
Features	6
High quality sound.....	6
High performance.....	7
Easy operation.....	7

Part names and functions

Front panel	8
Rear panel	10
Remote control unit	12
Amplifier operations.....	12
CD player operations.....	13
Network audio player operations.....	14

Connections

Speaker connection	16
Connecting the speakers cables.....	16
Speaker A/B connection.....	17
Bi-wiring connection.....	18

Connecting a playback device	19
Connecting a recording device	20
Connecting amplifiers	21
Connecting devices with remote control connectors	22
Performing operations by RC on this unit without visual contact.....	22
Remotely connecting Marantz devices.....	22
Connecting the power cord	23

Playback

Turning the power on.....	25
Selecting the speakers for audio output.....	26
Selecting the input source.....	26
Adjusting the volume.....	26
Turning off the sound temporarily.....	26
Adjusting the tone.....	26
Playing CDs.....	27
Recording.....	28



Settings

Setting the Auto Standby mode	<u>30</u>
Turning Auto Standby mode off	<u>30</u>
Turning Auto Standby mode on	<u>30</u>
Setting the power amp direct mode	<u>31</u>
Turning power amp direct mode on	<u>31</u>
Turning power amp direct mode off.....	<u>31</u>

Tips

Contents	<u>32</u>
Tips.....	<u>33</u>
Troubleshooting	<u>34</u>

Appendix

Explanation terms.....	<u>39</u>
Trademark information.....	<u>39</u>
Specifications	<u>40</u>
Index	<u>42</u>



Thank you for purchasing this Marantz product. To ensure proper operation, please read this owner's manual carefully before using the product. After reading this manual, be sure to keep it for future reference.

Accessories

Check that the following parts are supplied with the product.

① Getting Started

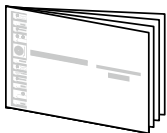

② CD-ROM (Owner's Manual)



③ Safety Instructions

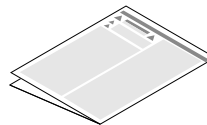

④ Power cord



⑤ Remote control unit
(RC002PM5A)

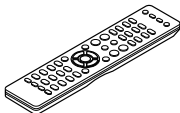

⑥ R03/AAA batteries



Inserting the batteries

- 1 Remove the rear lid in the direction of the arrow and remove it.

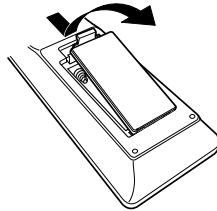

- 2 Load the two batteries properly as indicated by the ⊕ and ⊖ marks in the battery compartment.

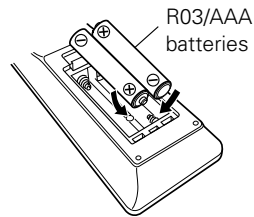

- 3 Put the rear cover back on.

NOTE

- When inserting the batteries, be sure to do so in the proper direction, following the ⊕ and ⊖ marks in the battery compartment.
- To prevent damage or leakage of battery fluid:
 - Do not use a new battery together with an old one.
 - Do not use two different types of batteries.
- Remove the batteries from the remote control unit if it will not be in use for long periods.
- If the battery fluid should leak, carefully wipe the fluid off the inside of the battery compartment and insert new batteries.

Operating range of the remote control unit

Point the remote control unit at the remote sensor when operating it.

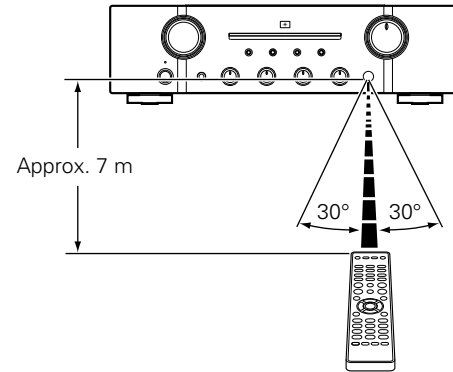

Features

High quality sound

- **All-discrete current-feedback amplifier**

Marantz proprietary current-feedback circuit, using discrete components, is adopted in the pre-amplifier and power amplifier. It is a high-speed amplifier using the latest technology developed for the higher-grade amplifiers.

- **HDAM®SA3 Module**

This unit includes the HDAM®SA3 which had been developed for high-end models. The HDAM®SA3 is incorporated into many components, such as the current feedback phono equalizer.

- **Improved momentary current supply ability**

It is generally known that the sound quality is not necessarily the same even if amplifiers have the same specifications. Marantz considers the cause to be the power to drive speakers. The power amplifier of this unit has the ability to momentarily supply current of 45 A or more to drive speakers strongly.

- **Short-power-line layout**

For strong momentary current supply, a short power-line layout unifies the power circuit and output stage of the power amplifier section. This layout allows connecting the large-current lines via the shortest route while to arranging the left and right channels symmetrically.

- **CD direct buffer amplifier**

An input buffer amplifier exclusive for CD is mounted near the CD input jacks. This is a high-speed buffer amplifier made with discrete components, which avoids interference between right and left channels and can send the signals to the pre-amplifier with very high fidelity.

- **All-Discrete current-feedback phono equalizer**

As a phono equalizer amplifier for MM cartridges, a constant current-feedback PHONO equalizer of quality equal to that of the higher-grade model is used.



• Double-shielded triodal transformer

The unit is equipped with a toroidal power transformer to minimize vibration and leakage flux specific to the transformer. Especially to reduce leakage flux, which affects sound quality, the periphery is double-shielded, using a core ring and a short ring.

• Block condenser of large capacity

The unit is equipped with a newly developed 18000 μ F large capacity condenser that incorporates the concepts of high-end devices into the power amplifier power circuit.

• Two-sets of speaker output terminals

In addition to using two sets of speakers (Speakers A and Speakers B), you can connect to bi-wiring speakers with separate input terminals for high range and low range ( [page 18](#)). The unit adopts screw terminals that can connect thick audio cables.

High performance

• Tri-tone control

This unit is equipped with a tone control function that enables adjustment of the strength of the mid range as well as the low and high ranges ( [page 26](#)).

• Power Amplifier Direct In Mode

In this mode, this unit works as a power amplifier. This mode will be useful in home theater systems.

Easy operation

• Remote control compatible with CD players and network audio players

The remote control provided with this unit can control Marantz CD players and network audio players in addition to this unit ( [page 13](#)).



Part names and functions

Front panel

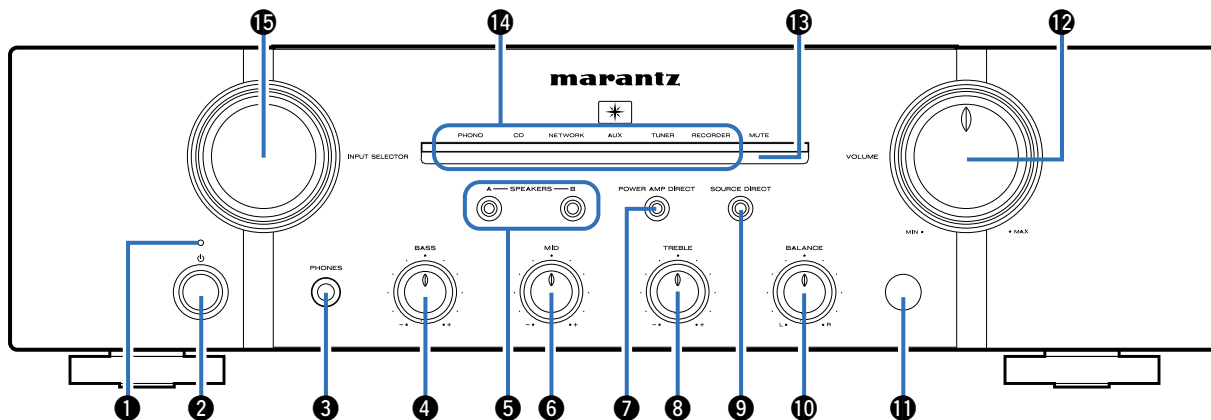

1 Power indicator

This is lit as follows according to the power status :

- Power on : Off
- Standby : Red
- Power off : Off
- When the protection circuit is activated : Red (blinking)

2 Power operation button (⏻)

This turns the power on/off ([page 25](#)).

3 Headphone jack (PHONES)

Used to connect headphones.

Turn off speaker output when using headphones ([page 26](#)).

NOTE

- To prevent hearing loss, do not raise the volume level excessively when using headphones.

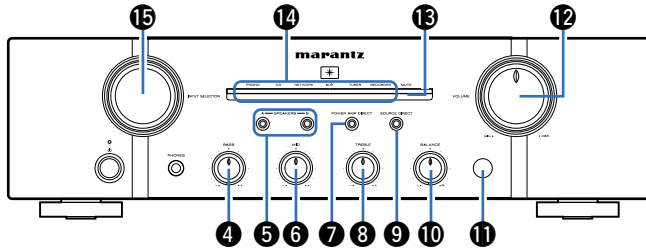

**4 BASS control knob**

This adjusts the bass ([page 26](#)).

5 Speaker switching buttons/indicators (SPEAKERS A/B)

These select the speaker for audio output ([page 26](#)).

6 MID control knob

This adjusts the mid ([page 26](#)).

7 Power amplifier direct mode button/indicator (POWER AMP DIRECT)

This switches the power amp direct mode on/off ([page 31](#)).

8 TREBLE control knob

This adjusts the treble ([page 26](#)).

9 SOURCE DIRECT button/indicator

This turns SOURCE DIRECT mode on/off ([page 27, 30](#)).

10 BALANCE control knob

This adjusts the balance of the volume output from the left and right speakers ([page 26](#)).

11 Remote control sensor

This receives signals from the remote control unit ([page 5](#)).

12 VOLUME control knob

This adjusts the volume level ([page 26](#)).

13 MUTE indicator

This lights while the sound is muted ([page 26](#)).

14 Input indicator ([page 26](#))**15 Input source select knob (INPUT SELECTOR)**

This selects the input source ([page 26](#)).

NOTE

- **4**, **6**, **8** and **10** can be adjusted when **9** is off (SOURCE DIRECT mode is off).



Rear panel

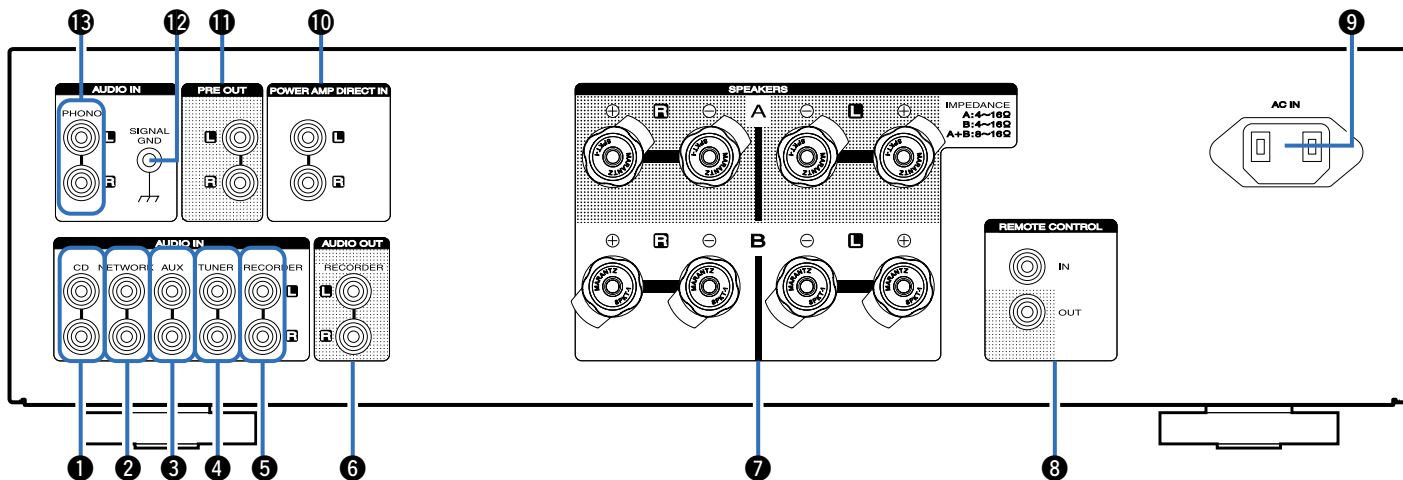

① CD input connectors

Used to connect a CD player ([🔗 page 19](#)).

② Network audio player input connectors (NETWORK)

Used to connect a network audio player ([🔗 page 19](#)).

③ AUX input connectors

Used to connect a player ([🔗 page 19](#)).

④ Tuner input connectors (TUNER)

Used to connect a tuner ([🔗 page 19](#)).

⑤ Recorder input connectors (RECORDER)

Used to connect the output connector of a recorder ([🔗 page 20](#)).

⑥ Recorder output connectors (RECORDER)

Used to connect the input connector of a recorder ([🔗 page 20](#)).

⑦ Speaker system terminals (SPEAKERS)

Used to connect speakers ([🔗 page 16](#)).



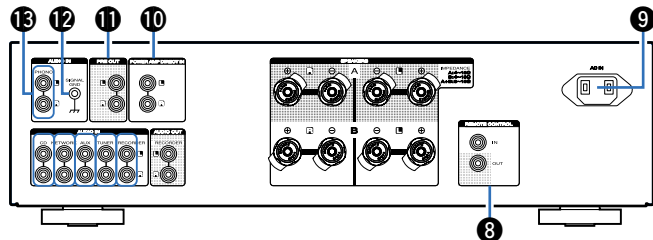

8 Remote control input/output connectors (REMOTE CONTROL)

Used to connect to a Marantz audio device that is compatible with the remote control function ([page 22](#)).

9 AC inlet (AC IN)

Used to connect the power cord ([page 23](#)).

10 Power amplifier direct connectors (POWER AMP DIRECT IN)

Used to connect a pre-amplifier when this unit is used as a power amplifier ([page 21](#)).

11 PRE OUT connectors

Use this to add such equipment as a power amplifier or subwoofer ([page 21](#)).



- When connecting a subwoofer, also consult the subwoofer instruction manual.

12 SIGNAL GND jacks

Used to connect a turntable ([page 19](#)).

13 Turntable input connectors (PHONO)

Used to connect a turntable ([page 19](#)).



Remote control unit

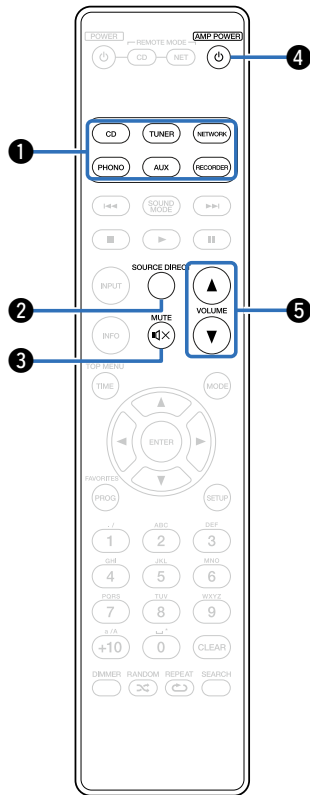

Amplifier operations

1 Input source select buttons

These select the input source (🔗 page 26).

2 SOURCE DIRECT button

This turns SOURCE DIRECT mode on/off (🔗 page 27).

3 MUTE button (M)

This mutes the audio (🔗 page 26).

4 AMP POWER button (P)

This turns the power on/off (standby) (🔗 page 25).

5 VOLUME buttons (▲▼)

These adjust the volume level (🔗 page 26).



- Press REMOTE MODE CD to switch the remote control to operate the CD player (🔗 page 13).
- Press REMOTE MODE NET to switch the remote control to operate the network audio player (🔗 page 14).



CD player operations

To operate Marantz CD player, press REMOTE MODE CD button to switch the remote control to the CD operation mode.

- REMOTE MODE CD button lights for approximately two seconds.

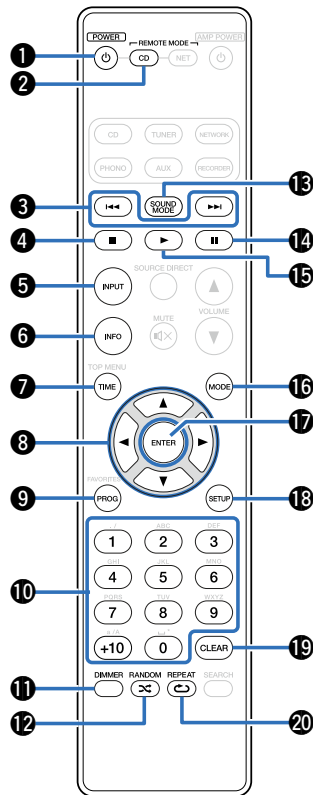

- ① POWER button (⏻)
- ② Remote mode select button (REMOTE MODE CD)
- ③ Reverse-skip/Forward-skip buttons (⏮, ⏭)
- ④ Stop button (■)
- ⑤ Input source select button (INPUT)
- ⑥ Information button (INFO)
- ⑦ TIME button
- ⑧ Cursor buttons (⬆, ⬇, ⬅, ⬇)
- ⑨ Program button (PROG)
- ⑩ Number buttons (0 – 9, +10)
- ⑪ DIMMER button
- ⑫ RANDOM button (⚡)
- ⑬ SOUND MODE button
- ⑭ Pause button (⏸)
- ⑮ Play button (▶)
- ⑯ Playback mode switching button (MODE)
- ⑰ ENTER button
- ⑱ SETUP button
- ⑲ CLEAR button
- ⑳ REPEAT button (↺)



- The amp can be operated with the amp operation buttons even when the remote control operation mode is set to CD. When using this remote control, also refer to the operating instructions of the other devices.



Network audio player operations

To operate Marantz network audio player, press REMOTE MODE NET button to switch the remote control to the NETWORK operation mode.

- REMOTE MODE NET button lights for approximately two seconds.

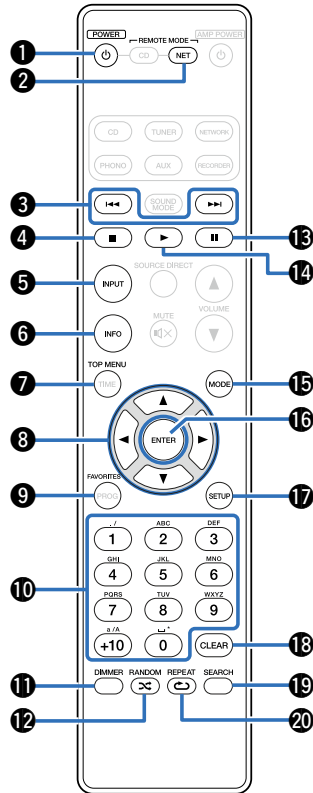

- 1 POWER button (⏻)
- 2 Remote mode select button (REMOTE MODE NET)
- 3 Reverse-skip/Forward-skip buttons (⏮, ⏭)
- 4 Stop button (■)
- 5 Input source select button (INPUT)
- 6 Information button (INFO)
- 7 TOP MENU button
- 8 Cursor buttons (⬆, ⬇, ⬅, ➤)
- 9 FAVORITES button
- 10 Number buttons (0 - 9, +10)

- 11 DIMMER button
- 12 RANDOM button (⚡)
- 13 Pause button (⏸)
- 14 Play button (▶)
- 15 Playback mode switching button (MODE)
- 16 ENTER button
- 17 SETUP button
- 18 CLEAR button
- 19 SEARCH button
- 20 REPEAT button (↺)



- The amp can be operated with the amp operation buttons even when the remote control mode is NET. When using this remote control, also refer to the operating instructions of the other devices.



Connections

Speaker connection (👉 page 16)

Connecting a playback device (👉 page 19)

Connecting a recording device (👉 page 20)

Connecting amplifiers (👉 page 21)

Connecting devices with remote control connectors
(👉 page 22)

Connecting the power cord (👉 page 23)

NOTE

- Do not plug in the power cord until all connections have been completed.
- Do not bundle power cords with connection cables. Doing so can result in humming or noise.

■ Cables used for connections

Provide necessary cables according to the devices you want to connect.

Speaker cable
(sold separately)

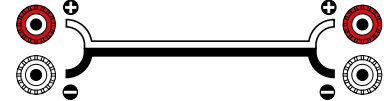

Audio cable
(sold separately)



Remote connector
cable (sold separately)



Speaker connection

NOTE

- Disconnect this unit's power plug from the power outlet before connecting the speakers.
- Connect so that the speaker cable core wires do not protrude from the speaker terminal. The protection circuit may be activated if the core wires touch the rear panel or if the + and – sides touch each other (see page 39 "Protection circuit").
- Never touch the speaker terminals while the power cord is connected.
- Use speakers with impedances within the ranges shown below to suit how they are used.

Speakers used	Impedance
SPEAKERS A (Standard connection)	4 – 16 Ω /ohms
SPEAKERS B	4 – 16 Ω /ohms
SPEAKERS A and SPEAKERS B	8 – 16 Ω /ohms
SPEAKERS A and SPEAKERS B (for bi-wiring connections)	4 – 16 Ω /ohms

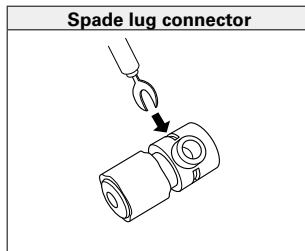

Connecting the speakers cables

Carefully check the left (L) and right (R) channels and + (red) and – (white) polarities on the speakers being connected to the unit, and be sure to connect the channels and polarities correctly.

- 1 Peel off about 10 mm of sheathing from the tip of the speaker cable, then either twist the core wire tightly or apply solder to it.**
- 2 Turn the speaker terminal counterclockwise to loosen it.**
- 3 Insert the speaker cable's core wire to all the way into the speaker terminal.**
- 4 Turn the speaker terminal clockwise to tighten it.**

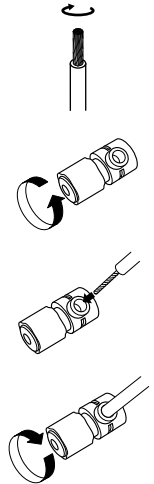

Speaker A/B connection

- The same signal is output from the SPEAKERS A and SPEAKERS B terminals.
- When only one set of speakers is to be connected, use either the SPEAKERS A or SPEAKERS B terminals.

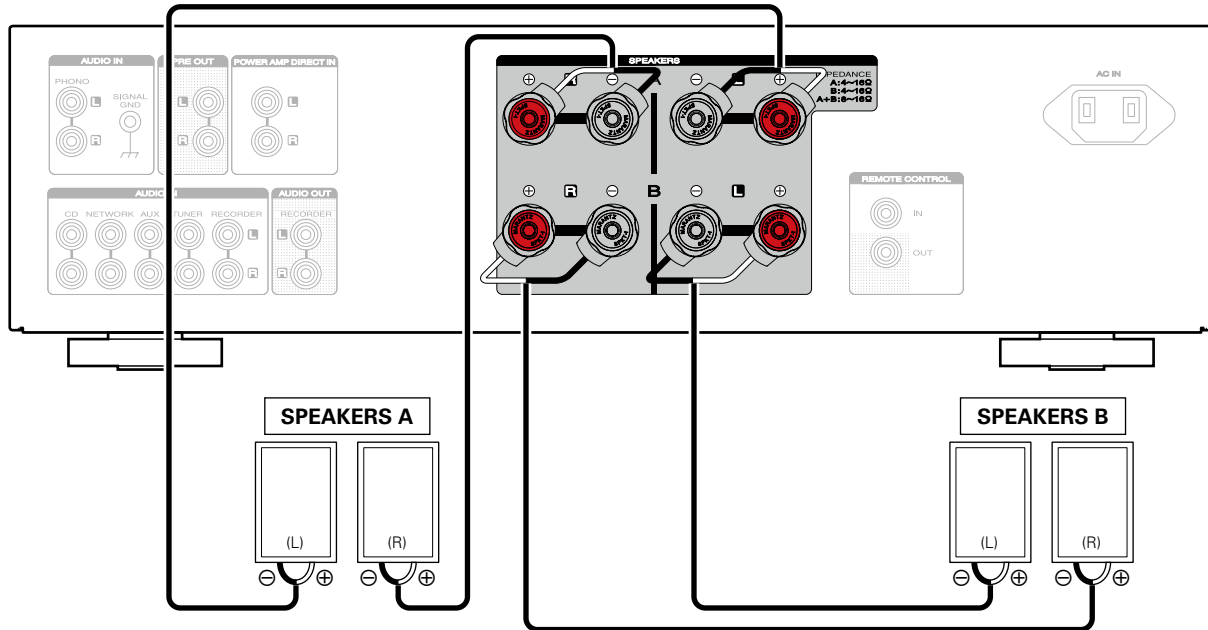

Bi-wiring connection

- When bi-wiring with bi-wireable speakers, connect the mid and high range terminals to SPEAKERS A (or SPEAKERS B), the low range terminals to SPEAKERS B (or SPEAKERS A).
- This connection limits the effect of signal interference between the high range speakers and low range speakers, allowing you to enjoy high quality playback.

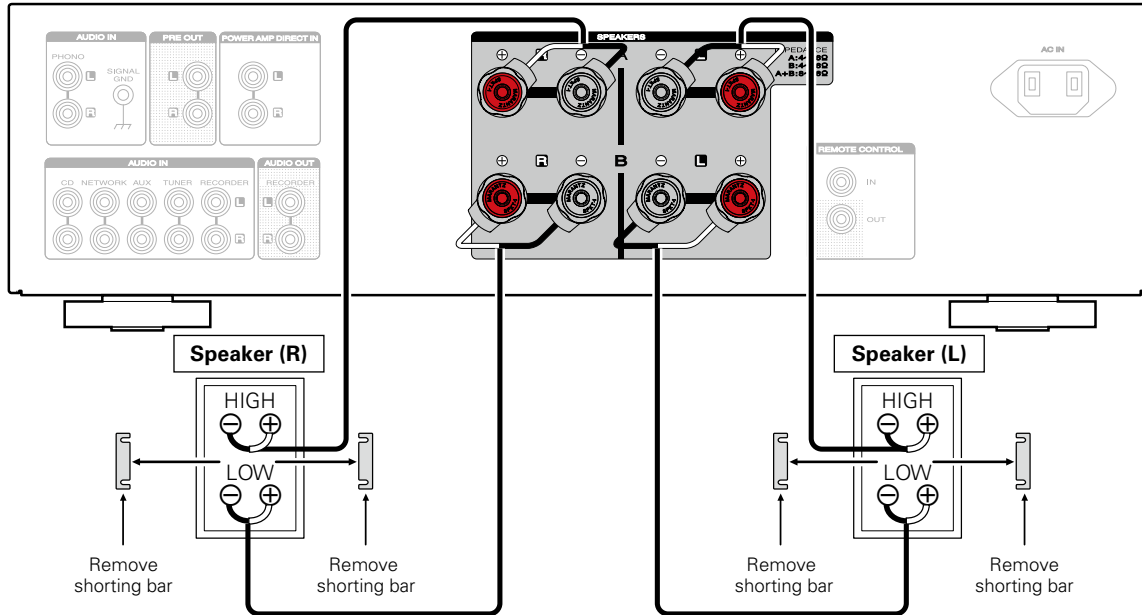

Connecting a playback device

You can connect Blu-ray disc players, turntables, CD players, network audio players and tuners to this unit.

This unit is compatible with turntables equipped with a moving magnet (MM) phono cartridge. When you connect to a turntable with a low output moving coil (MC) cartridge, use a commercially available MC head amp or a step-up transformer.

If you set this unit's input source to "PHONO" and you accidentally increase the volume without having a turntable connected, you may hear a hum noise from the speakers.

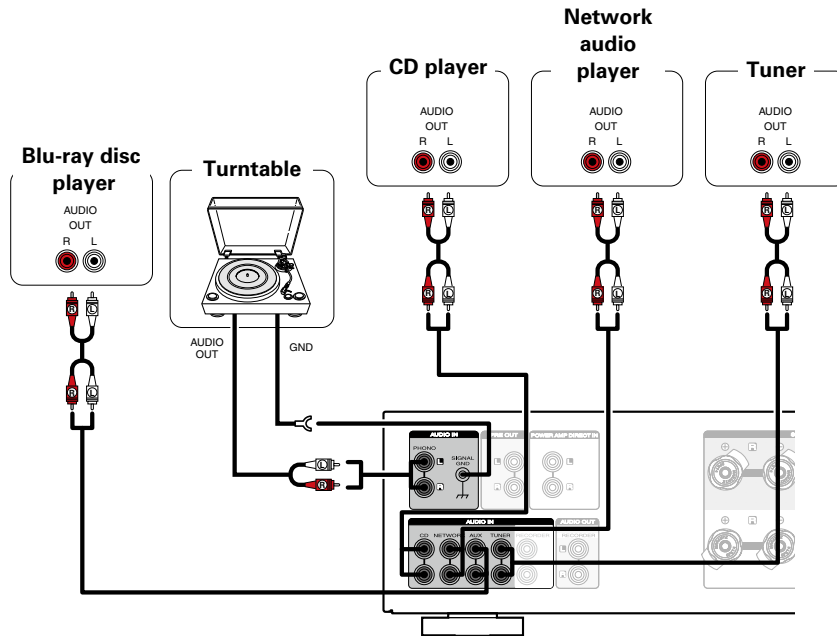

NOTE

- The ground line (SIGNAL GND) on this unit is not a safety ground. Connect it to reduce noise when noise is excessive. Note that depending on the turntable, connecting the ground line may have the reverse effect of increasing noise. In this case, it is not necessary to connect the ground line.



Connecting a recording device

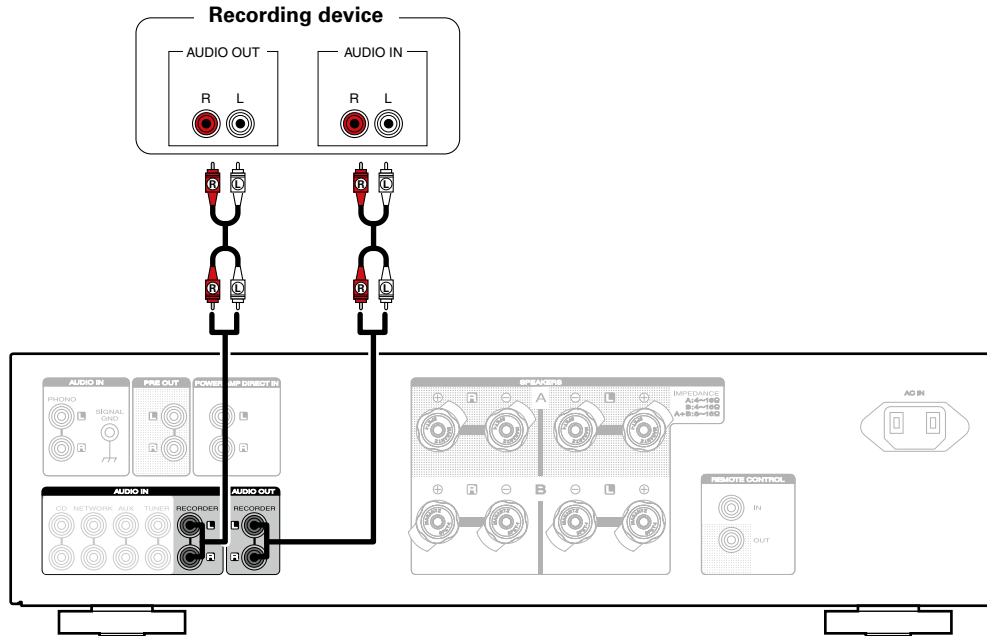

NOTE

- Never insert the short-circuiting pin plug into the recording output connectors (AUDIO OUT RECORDER). Doing so could result in damage.



Connecting amplifiers

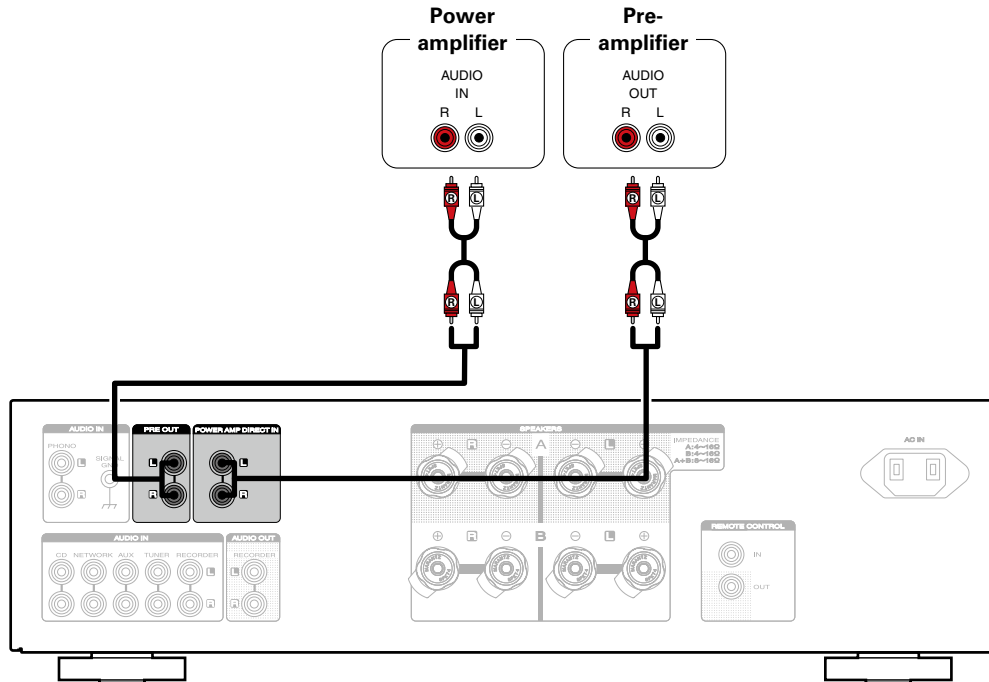

NOTE

- Never insert the short-circuiting pin plug into the PRE OUT terminals. Doing so could result in damage.



Connecting devices with remote control connectors

Performing operations by RC on this unit without visual contact

You can connect an external IR receiver to the REMOTE CONTROL connectors to perform operations on this unit with the supplied remote control unit without visual contact. This might be necessary if the unit is hidden in a cupboard or corner, so you can't directly point with the remote control unit to the device.

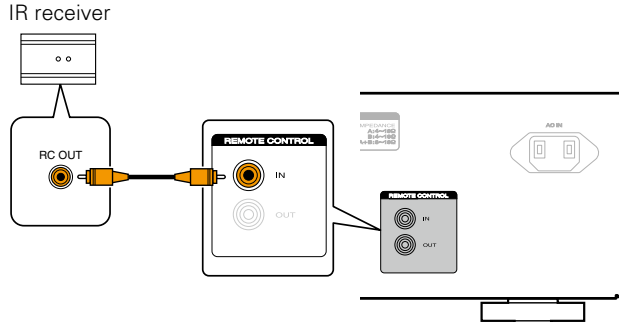

Remotely connecting Marantz devices

You can transmit remote control signals simply by connecting a Marantz audio device to the REMOTE CONTROL IN/OUT connectors using the remote connection cable provided with the device.

Set the remote control switch located on the rear panel of the connected audio component to "EXTERNAL" to use this feature.

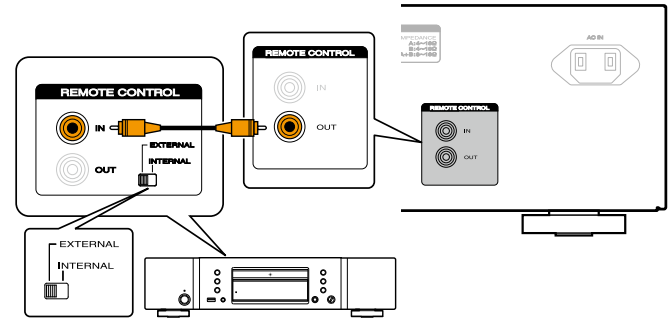

Connecting the power cord

Wait until all connections have been completed before connecting the power cord.

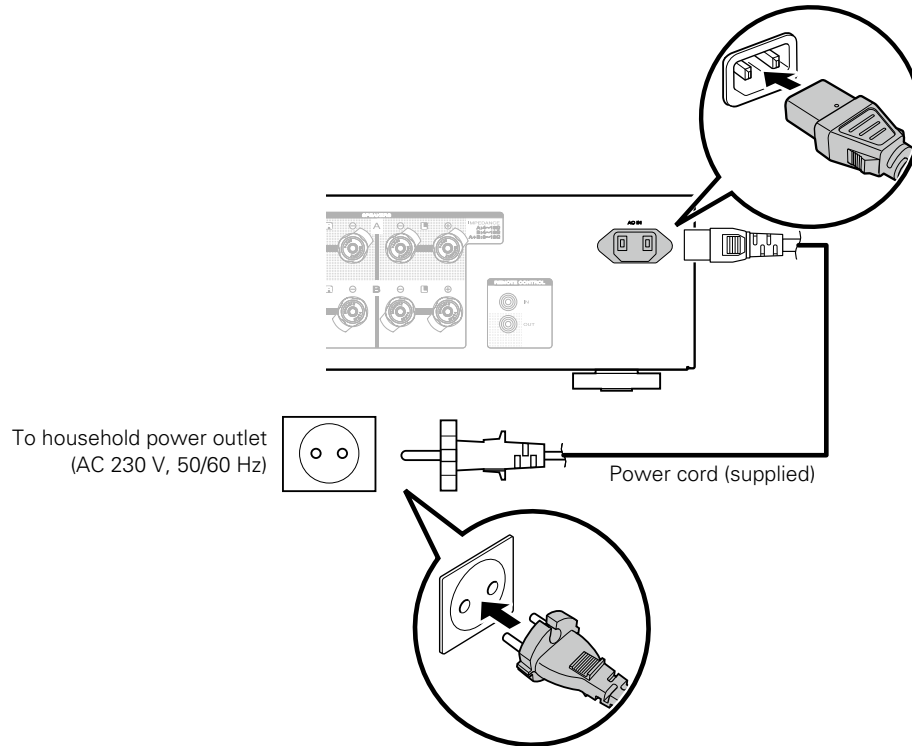

Playback

Turning the power on (👉 page 25)

Selecting the speakers for audio output (👉 page 26)

Selecting the input source (👉 page 26)

Adjusting the volume (👉 page 26)

Turning off the sound temporarily (👉 page 26)

Adjusting the tone (👉 page 26)

Playing CDs (👉 page 27)

Recording (👉 page 28)



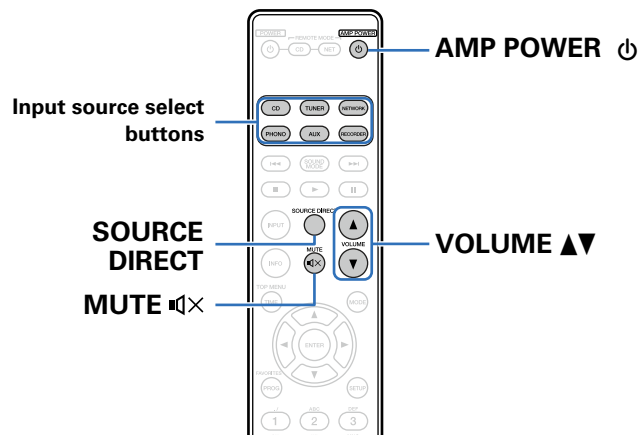

Turning the power on

- 1 Press **⏻** on this unit to turn the power on.
Input indicator for the selected source lights.

NOTE

- Turn VOLUME on this unit to adjust the volume to the lowest level before turning on the power.

Turning the power standby

- 1 Press **AMP POWER** ⏻.
The standby indicator lights red.



- Press AMP POWER ⏻ to turn on power from standby mode.
- You can also turn on power by using either INPUT SELECTOR on this unit from standby mode.

Turning the power off

- 1 Press **⏻** on this unit to turn the power off.
All indicators turn off.

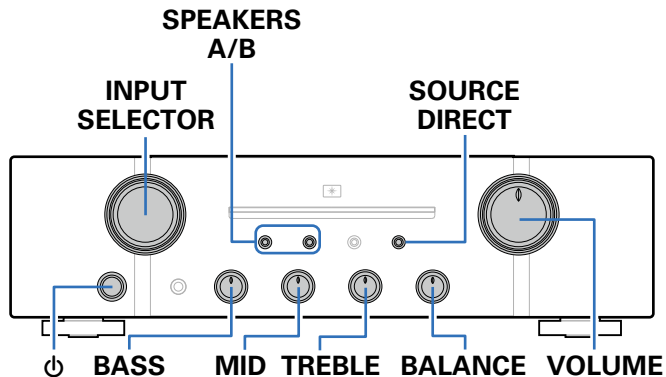

Selecting the speakers for audio output

1 Press **SPEAKERS A/B** to select the speaker system to be used for playback.

The indicator of the selected speakers lights.



- Press **SPEAKERS A/B** to turn the speaker audio output off, and the speaker switching indicator turns off.

Selecting the input source

1 Press the **input source select button** to be played back.

The indicator of the selected input source lights.



- You can also select the input source by turning **INPUT SELECTOR** on the main unit.

Adjusting the volume

1 Use **VOLUME ▲▼** to adjust the volume.



- You can also adjust the volume by turning **VOLUME** on the main unit.

Turning off the sound temporarily

1 Press **MUTE** .

The mute indicator lights.



- Muting can be cancelled by pressing **MUTE**  again.

Adjusting the tone



1 Turn the **BASS, MID, TREBLE** and **BALANCE** control knobs to adjust the tone.

NOTE

- When the source direct mode is on, the tone cannot be adjusted because the audio signal does not pass through the tone adjustment circuit (**BASS, MID, TREBLE, BALANCE**). Check that the source direct indicator is off.



Playing CDs

- 1 Press  on this unit to turn the power on.
- 2 Press the input source select buttons to switch the input source to "CD".
The "CD" input indicator lights.
- 3 Playback the CD.
- 4 Use VOLUME   to adjust the volume.

■ Playback in source direct mode

The signal does not pass through the tone adjustment circuitry (BASS, MID, TREBLE and BALANCE), resulting in playback of a higher sound quality.

- 1 Press SOURCE DIRECT to turn on source direct mode.
The SOURCE DIRECT indicator lights.



Recording

- 1 Press  on this unit to turn the power on.**
- 2 Press the input source select buttons to switch to the input source from which you want to record.**

The indicator of the selected input source lights.
- 3 Recording starts.**
 - For information on operations, see the owner's manual of the recording device.



Settings

Setting the Auto Standby mode (👉 [page 30](#))

Setting the power amp direct mode (👉 [page 31](#))



Setting the Auto Standby mode

You can set the unit to automatically switch to standby mode if the unit is not operated for 30 minutes when there is no audio input. Auto Standby mode is set to on by default.

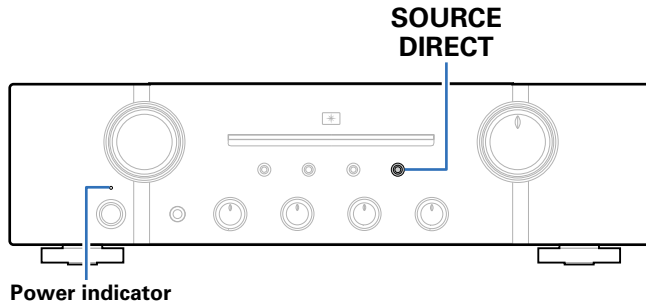

Turning Auto Standby mode off

- 1 Press and hold SOURCE DIRECT for more than 5 seconds to turn the Auto Standby mode off.**
The power indicator flashes once.

Turning Auto Standby mode on

- 1 Press and hold SOURCE DIRECT for more than 5 seconds to turn the Auto Standby mode on.**
The power indicator flashes three times.



Setting the power amp direct mode

When a pre-amplifier is connected to this unit and the unit is used as a power amplifier, follow the instructions below to turn power amp direct mode on.

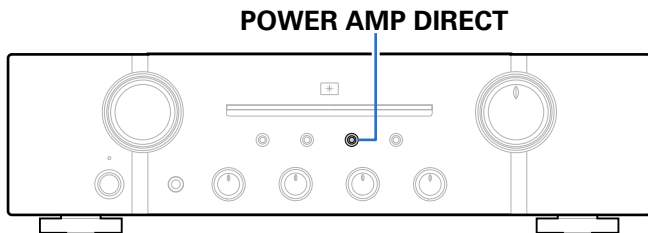

Turning power amp direct mode on

- 1 Press and hold POWER AMP DIRECT for more than 3 seconds to turn the power amp direct mode on.**

The power amp direct indicator lights and the power amp direct mode turns on. The input source switching function of the unit is disabled, and the device connected to the power amp direct input terminal is played back.

Turning power amp direct mode off

- 1 Press and hold POWER AMP DIRECT for more than 3 seconds to turn the power amp direct mode off.**

The power amp direct indicator turns off and the power amp direct mode turns off.

NOTE

- When the power amp direct mode is on, adjustment of the volume, balance and tone on the main unit has no effect. Adjust the volume on the pre-amplifier.
- When the power amp direct mode is on, the main unit outputs at maximum volume. Check the output level on the input device before playing it and adjust the volume accordingly.



Tips

Contents

■ Tips	(33)	■ Troubleshooting	(34)
I want to adjust the tone myself	(33)	Power does not turn on/Power is turned off	(34)
I want sound playback that is faithful to the original sound	(33)	Operations cannot be performed through the remote control unit.....	(36)
I want to operate a Marantz CD player or network audio player using the remote control from of unit	(33)	No sound comes out.....	(37)
I want to use this unit as a power amplifier	(33)	Desired sound does not come out.....	(38)
I want to use this unit as a pre-amplifier	(33)	Sound is interrupted or noise occurs.....	(38)



Tips

I want to adjust the tone myself

- Use the BASS, MID, TREBLE and BALANCE knobs to adjust the sound as desired ( [page 26](#)).

I want sound playback that is faithful to the original sound

- Set the Source Direct mode on ( [page 27](#)).

I want to operate a Marantz CD player or network audio player using the remote control of this unit

- Switch the remote control operating mode ( [page 13, 14](#)).
- Also refer to the CD player or network audio player instruction manuals.

I want to use this unit as a power amplifier

- Set the power amp direct mode on ( [page 31](#)).

I want to use this unit as a pre-amplifier

- Connect a power amplifier to the pre out connectors of this unit ( [page 21](#)).



Troubleshooting

If a problem occurs, first check the following:

1. Are the connections correct?
2. Is the unit being operated as described in the owner's manual?
3. Are the other components operating properly?

If this unit does not operate properly, check the items listed in the table below. If the problem persists there may be a malfunction. In that case, disconnect the power immediately and contact your retail outlet.

■ Power does not turn on/Power is turned off

Symptom	Cause / Solution	Page
Power does not turn on.	<ul style="list-style-type: none"> • Check whether the power plug is correctly inserted into the power outlet. 	<u>23</u>
Power automatically turns off.	<ul style="list-style-type: none"> • The Auto Standby mode is set. The Auto Standby mode switches the unit to standby mode when the unit is not operated for approximately 30 minutes. To disable the Auto Standby mode, press and hold the SOURCE DIRECT button on the unit for more than 5 seconds when the Auto Standby mode is enabled. 	<u>30</u>



Symptom	Cause / Solution	Page
Power turns off and the power indicator flashes red approx. every 0.5 seconds.	<ul style="list-style-type: none"> • Due to the temperature rise within this unit, the protection circuit is working. Turn off the power and wait about an hour until this unit sufficiently cools down. Then, turn on the power again. • Please re-install this unit in a place having good ventilation. 	<p><u>39</u></p> <p>–</p>
Power turns off and the power indicator flashes red approx. every 0.25 seconds.	<ul style="list-style-type: none"> • Check the speaker connection. The protection circuit may have been activated because speaker cable core wires came in contact with each other or a core wire was disconnected from the connector and came in contact with the rear panel of this unit. After unplugging the power cord, take corrective action such as firmly re-twisting the core wire or taking care of the connector, and then reconnect the wire. • Turn down the volume and turn on the power again. 	<p><u>16, 39</u></p> <p><u>25, 26</u></p>
When the power is turned on, the power indicator flashes red approx. every 0.25 seconds.	<ul style="list-style-type: none"> • This unit's amplifier circuit has failed. Turn off the power and please contact the Marantz service adviser. 	–



■ Operations cannot be performed through the remote control unit

Symptom	Cause / Solution	Page
Operations cannot be performed through the remote control unit.	• Batteries are worn out. Replace with new batteries.	5
	• Operate the remote control unit within a distance of about 7 m from this unit and at an angle of within 30°.	5
	• Remove any obstacle between this unit and the remote control unit.	–
	• Insert the batteries in the proper direction, checking the ⊕ and ⊖ marks.	5
	• The set's remote control sensor is exposed to strong light (direct sunlight, inverter type fluorescent bulb light, etc.). Move the set to a place in which the remote control sensor will not be exposed to strong light.	–
	• When using a 3D video device, the remote control unit of this unit may not function due to effects of infrared communications between units (such as TV and glasses for 3D viewing). In this case, adjust the direction of units with the 3D communications function and their distance to ensure they do not affect operations from the remote control unit of this unit.	–



■ No sound comes out

Symptom	Cause / Solution	Page
No sound comes out of speakers.	• Check the connections for all devices.	<u>15</u>
	• Insert connection cables all the way in.	–
	• Check that input connectors and output connectors are not reversely connected.	–
	• Check cables for damage.	–
	• Check that speaker cables are properly connected. Check that cable core wires come in contact with the metal part on speaker terminals. Also, securely tighten speaker terminals. Check speaker terminals for looseness.	<u>16</u>
	• Check that a proper input source is selected.	<u>26</u>
	• Adjust the volume.	<u>26</u>
• Cancel the mute mode.	<u>26</u>	
• Check the settings of the SPEAKERS A/B button.	<u>26</u>	



■ Desired sound does not come out

Symptom	Cause / Solution	Page
No sound comes out of a specific speaker.	<ul style="list-style-type: none"> • Check that the speaker cable is properly connected. • Adjust the BALANCE control knob. 	<p>16</p> <p>26</p>
The left and right of stereo sound is reversed.	<ul style="list-style-type: none"> • Check whether the left and right speakers are connected to the correct speaker terminals. 	17

■ Sound is interrupted or noise occurs

Symptom	Cause / Solution	Page
When playing a record, the sound is distorted.	<ul style="list-style-type: none"> • Adjust to a proper needle pressure. • Check the tip of the needle. • Replace the cartridge. 	<p>–</p> <p>–</p> <p>–</p>
When playing a record, a humming noise comes out of the speakers.	<ul style="list-style-type: none"> • Check that the turntable is connected correctly. • If there is a TV or AV device near the turntable, such devices may affect the playback sound. Install the turntable in a location as far away as possible from the TV or other AV devices. 	<p>19</p> <p>–</p>
When playing a record at high volume, a “howling” sound comes out of the speakers.	<ul style="list-style-type: none"> • Install the turntable and speakers as far from each other as possible. • The vibrations from the speakers are being transmitted to the player through the floor. Use cushions, etc., to absorb the speakers’ vibrations. 	<p>19</p> <p>–</p>



Appendix

Explanation terms

P

Protection circuit

This is a function to prevent damage to devices within the power supply when an abnormality such as an overload, excess voltage occurs or over temperature for any reason.

If a malfunction occurs in this unit, the power indicator blinks red and the unit switches to standby mode.

S

Source direct

Playback with higher fidelity to the source becomes possible, as input audio signals are output by bypassing the audio quality-control circuits (BASS/MID/TREBLE/BALANCE).

Speaker impedance

This is an AC resistance value, indicated in Ω (ohms). Greater power can be obtained when this value is smaller.

Trademark information



Adobe, the Adobe logo and Reader are either registered trademarks or trademarks of Adobe Systems Incorporated in the United States and/or other countries.



Specifications

- **RMS Power output**

(20 Hz – 20 kHz simultaneous drive of both channels) :

70 W x 2 (8 Ω/ohms load)
100 W x 2 (4 Ω/ohms load)

- **Total harmonic distortion**

(20 Hz – 20 kHz simultaneous drive of both channels,
8 Ω/ohms load) :

0.02 %

- **Output band width** (8 Ω/ohms load, 0.06 %) :

5 Hz – 60 kHz

- **Frequency response** (CD, 1 W, 8 Ω/ohms load) :

5 Hz – 100 kHz ±3.0 dB

- **Dumping factor** (8 Ω/ohms load, 40 Hz – 20 kHz) :

100

- **Input sensitivity/Input impedance**

PHONO (MM) :

2 mV / 47 kΩ/kohms

CD, TUNER, NETWORK, AUX, RECORDER :

200 mV / 20 kΩ/kohms

POWER AMP DIRECT IN :

1.6 V / 15 kΩ/kohms

- **Output voltage/Output impedance**

PRE OUT :

1.6 V / 600 Ω/ohms

- **Maximum allowable PHONO input level** (1 kHz)

MM :

100 mV

- **RIAA deviation** (20 Hz – 20 kHz) :

±0.5 dB



- **S/N** (IHF-A, 8 Ω /ohms load)
 - PHONO (MM) : 87 dB (5 mV input, 1 W output)
 - CD, TUNER, NETWORK, AUX, RECORDER : 106 dB (2 V input, Rated output)
 - POWER AMP DIRECT IN : 125 dB (Rated output)
- **Tone control**
 - Bass (50 Hz) : ± 10 dB
 - Mid (900 Hz) : ± 6 dB
 - Treble (15 kHz) : ± 10 dB
- **Power requirement** : AC 230 V, 50/60 Hz
- **Power consumption** (EN60065) : 220 W
- **Power consumption in standby mode** : 0.2 W

For the purpose of improvement, the specifications and design are subject to change without notice.



Index

A

Accessories.....	4
Adjusting the tone.....	26
BALANCE.....	26
BASS.....	26
MID.....	26
TREBLE.....	26
Adjusting the volume.....	26
Auto Standby mode.....	30

C

Cables used for connections.....	15
Connection	
Players.....	19
Power amplifier.....	21
Power cord.....	23
Pre-amplifier.....	21
Recording device.....	20
Remote control connectors.....	22
Speaker.....	16, 17
Speaker (Bi-wiring).....	18

P

Power amp direct mode.....	31
Protection circuit.....	39

R

Remote control unit.....	12
Inserting the batteries.....	5

S

Selecting the input source.....	26
Source direct.....	27, 39
Speaker impedance.....	39

T

Tips.....	33
Troubleshooting.....	34
Turning off the sound temporarily.....	26
Turning the power on.....	25



■ Dimensions

Unit : mm

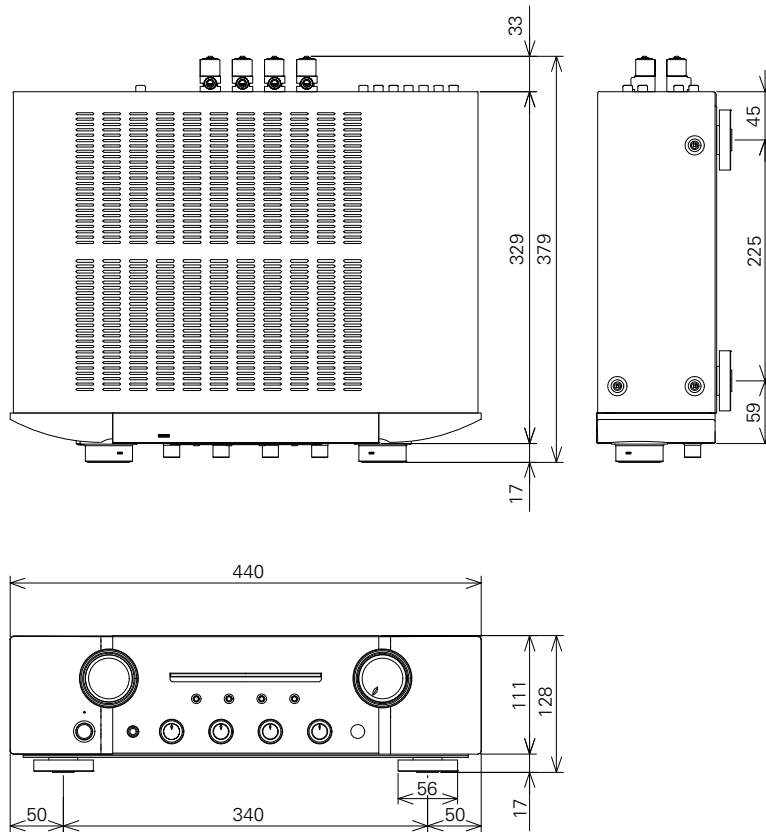

■ Weight : 12.0 kg

Front panel

Rear panel

Remote

43

Index



www.marantz.com

You can find your nearest authorized distributor or dealer on our website.

marantz[®] is a registered trademark.

D&M Holdings Inc.
3520 10267 00AM