

marantz®

Model SR2100 User Guide

Tuner Amplifier

ENGLISH

WARRANTY

For warranty information, contact your local Marantz distributor.

RETAIN YOUR PURCHASE RECEIPT

Your purchase receipt is your permanent record of a valuable purchase. It should be kept in a safe place to be referred to as necessary for insurance purposes or when corresponding with Marantz.

IMPORTANT

When seeking warranty service, it is the responsibility of the consumer to establish proof and date of purchase. Your purchase receipt or invoice is adequate for such proof.

FOR U.K. ONLY

This undertaking is in addition to a consumer's statutory rights and does not affect those rights in any way.

FRANÇAIS

GARANTIE

Pour des informations sur la garantie, contacter le distributeur local Marantz.

CONSERVER L'ATTESTATION D'ACHAT

L'attestation d'achat est la preuve permanente d'un achat de valeur. La conserver en lieu sûr pour s'y reporter aux fins d'obtention d'une couverture d'assurance ou dans le cadre de correspondances avec Marantz.

IMPORTANT

Pour l'obtention d'un service couvert par la garantie, il incombe au client d'établir la preuve de l'achat et d'en corroborer la date. Le reçu ou la facture constituent des preuves suffisantes.

DEUTSCH

GARANTIE

Bei Garantiefragen wenden Sie sich bitte an Ihren Marantz-Händler.

HEBEN SIE IHRE QUITTING GUT AUF

Die Quittung dient Ihnen als bleibende Unterlage für Ihren wertvollen Einkauf. Das Aufbewahren der Quittung ist wichtig, da die darin enthaltenen Angaben für Versicherungswecke oder bei Korrespondenz mit Marantz angeführt werden müssen.

WICHTIG!

Bei Garantiefragen muß der Kunde eine Kaufunterlage mit Kaufdatum vorlegen. Ihren Quittung oder Rechnung ist als Unterlage ausreichend.

NEDERLANDS

GARANTIE

Voor inlichtingen omtrent garantie dient u zich tot uw plaatselijke Marantz.

UW KWITANTIE, KASSABON E.D. BEWAREN

Uw kwitantie, kassabon e.d. vormen uw bewijs van aankoop van een waardevol artikel en dienen op een veilige plaats bewaard te worden voor evt, verwijzing bijv, in verbend met verzekering of bij correspondentie met Marantz.

BELANGRIJK

Bij een evt, beroep op de garantie is het de verantwoordelijkheid van de consument een gedateerd bewijs van aankoop te tonen. Uw kassabon of factuur zijn voldoende bewijs.

ESPAÑOL

GARANTIA

Para obtener información acerca de la garantía póngase en contacto con su distribuidor Marantz.

GUARDE SU RECIBO DE COMPRA

Su recibo de compra es su prueba permanente de haber adquirido un aparato de valor, Este recibo deberá guardarlo en un lugar seguro y utilizarlo como referencia cuando tenga que hacer uso del seguro o se ponga en contacto con Marantz.

IMPORTANTE

Cuando solicite el servicio otorgado por la garantía el usuario tiene la responsabilidad de demostrar cuándo efectuó la compra. En este caso, su recibo de compra será la prueba apropiada.

ITALIANO

Condizioni di garanzia

L'apparecchio è garantito per 365 giorni dalla data di acquisto comprovata da un documento attestante il nominativo del rivenditore e la data di vendita. La garanzia sarà prestata con la sostituzione o riparazione gratuita delle parti difettose.

Non sono coperti da garanzia difetti derivanti da uso improprio, errata installazione, manutenzione effettuata da personale non autorizzato o, comunque, da circostanze che non possano riferirsi a difetti di funzionamento dell'apparecchio. Sono inoltre esclusi dalla garanzia gli interventi inerenti l'installazione e l'allacciamento agli impianti di alimentazione.

Gli apparecchi verranno riparati presso i nostri Centri di Assistenza. Le spese ed i rischi di trasporto sono a carico del cliente.

La casa costruttrice declina ogni responsabilità per danni diretti o indiretti provocati dalla inosservanza delle prescrizioni di installazione, uso e manutenzione dettagliate nel presente manuale.

Per informazioni sull'abbonamento al Servizio Assistenza postgaranzia e per conoscere l'indirizzo dei Centri Assistenza Marantz rivolgetevi al nostro servizio consumatori (telefono 1678-20026 - numero verde).

PORTUGUÊS

GARANTIA

Para informações sobre a garantia, contactar o distribuidor Marantz local.

GUARDAR O RECIBO DE COMPRA

O recibo é o registo permanente da compra que fez. Deve ser guardado num local seguro, para ser apresentado em questões relacionadas com o seguro ou para quando tiver de contactar a Marantz.

IMPORTANTE

Quando procurar assistência técnica ao abrigo da garantia, é da responsabilidade do consumidor estabelecer a prova e data de compra.

O recibo é prova adequada.

SVENSKA

GARANTI

För information om garantin, kontakta Marantz lokalagent.

SPAR KVITTOT

Kvittot är ett inköpsbevis på en värdefull vara. Det skall förvaras säkert och hänvisas till vid försäkringsfall eller vidkorrespondens mod Marantz.

VIKTIGT

Fö att garantin skall gälla är det kundens sak att framställa bevis och datum om köpet. Kvitto eller faktura är tillräckligt bevis för detta.

DANSK

GARANTI

Henvend dem til Deres MARANTZ-forhandler angående information om garantien.

GEM DERES KVITTERING

Deres købskvittering er Deres varige bevis på et dyrt køb. Den bør gemmes godt og anvendes som bevis, hvis De vil tegne en forsikring, eller hvis De kommunikerer med Marantz.

VIGTIGT

Det påhviler forbrugeren at skaffe bevis for købet og købsdatoen, hvis han eller hun ønsker garantiservice. Deres købskvittering eller faktura er et fulgyldigt bevis herpå.

CE MARKING

- English**
The SR2100 is in conformity with the EMC directive and low-voltage directive.
- Français**
Le SR2100 est conforme à la directive EMC et à la directive sur les basses tensions.
- Deutsch**
Das Modell SR2100 entspricht den EMC-Richtlinien und den Richtlinien für Niederspannungsgeräte.
- Nederlands**
De SR2100 voldoet aan de EMC eisen en de vereisten voor laag-voltage.
- Español**
El SR2100 está de acuerdo con las normas EMC y las relacionadas con baja tensión.
- Italiano**
Il SR2100 è conforme alle direttive CEE ed a quelle per i bassi voltaggi.
- Português**
O SR2100 conforma com as diretrizes EMC e de baixa voltagem.
- Svenska**
SR2100 är tillverkad i enlighet med EMC direktiven och direktiven för lågvoltutrustning.
- Dansk**
Model SR2100 er i overensstemmelse med EMC-direktivet og direktivet om lavspænding.

English

To ventilate the unit, do not install the unit in a rack or bookshelf, and note the followings.

- Do not touch the top of the enclosure during operation.
- Do not block the openings in the enclosure during operation.
- Do not insert objects beneath the unit.
- Do not block the ventilation slots at the top of the unit.
- Do not place anything about 1 meter above the top panel.
- Make a space of about 0.2 meter around the unit.

Français

Pour que l'appareil puisse être correctement ventilé, ne pas l'installer dans un meuble ou une bibliothèque et respecter ce qui suit.

- Ne pas toucher le dessus du coffret.
- Ne pas obstruer les ouïes de ventilation du coffret pendant le fonctionnement.
- Ne placer aucun objet sous l'appareil.
- Ne pas obstruer les ouïes de ventilation du panneau supérieur. Ne placer aucun objet à moins d'un mètre environ du panneau supérieur.
- Veiller à ce qu'aucun objet ne soit à moins de 0,2 mètre des côtés de l'appareil.

Deutsch

Um eine einwandfreie Belüftung des Geräts zu gewährleisten, darf das Gerät nicht in einem Gestell oder Bücherregal aufgestellt werden; die folgenden Punkte sind besonders zu beachten:

- Während des Betriebs das Oberteil des Gehäuses nicht berühren.
- Während des Betriebs die Öffnungen im Gehäuse nicht blockieren.
- Keine Gegenstände in das Gerät einführen.
- Die Belüftungsschlitze an der Oberseite des Geräts dürfen nicht blockiert werden. Darauf achten, daß über dem Gerät ein Freiraum von mindestens 1 meter vorhanden ist.
- Auf allen Geräteseiten muß ein Zwischenraum von ungefähr 0,2 meter vorhanden sein.

Nederlands

Installeer het toestel niet in een rek of boekenkast waar de ventilatie mogelijk wordt gehinderd. Let tevens op de volgende punten:

- Raak de bovenkant van het toestel niet aan als het in gebruik is.
- Blokkeer de openingen van het toestel niet als het in gebruik is.
- Plaats geen onderwerpen onder het toestel.
- Blokkeer de ventilatie-openingen aan de bovenkant van het toestel niet. Zorg dat er tenminste 1 meter vrije ruimte boven het toestel is.
- Zorg dat er 0,2 meter vrije ruimte rond het toestel is.

Español

Para ventilar la unidad no la instale en una estantería ni estante para libros, y tenga en cuenta lo siguiente:

- No toque la parte superior de la caja durante el funcionamiento.
- No tape las ranuras en la caja durante el funcionamiento.
- No ponga objetos debajo de la unidad.
- No tape las ranuras de ventilación de la parte superior de la unidad. No ponga nada a menos de 1 metro por encima del panel superior.
- Deje un espacio de unos 0,2 metro alrededor de la unidad.

Italiano

Perché l'unità possa essere sempre ben ventilata, non installarla in scaffali o librerie e tenere presente quanto segue.

- Non toccare la parte superiore del rivestimento durante il funzionamento.
- Non bloccare le aperture sul rivestimento durante il funzionamento.
- Non inserire oggetti al di sotto dell'unità.
- Non bloccare le fessure di ventilazione sopra l'unità. Non posare nulla per circa un metro sopra il pannello superiore.
- Lasciare 0,2 metro liberi tutto intorno l'unità.

Português

Para ventilar o aparelho, não instalá-lo dentro duma estante ou algo similar, e observar as seguintes recomendações:

- Não tocar a parte superior do aparelho durante a operação.
- Não bloquear as aberturas do aparelho durante a operação.
- Não inserir objectos debaixo do aparelho.
- Não bloquear as aberturas de ventilação na parte de cima do aparelho. Deixar um espaço completamente livre de cerca de 1 metro acima do painel superior.
- Deixar um espaço de cerca de 0,2 metro ao redor do aparelho.

Svenska

För att ventilera enheten, ställ den inte i ett ställ eller bokhylla och tänk på följande.

- Vidrör inte ytterhöljets ovansida under pågående drift.
- Blockera inte öppningarna i ytterhöljet under pågående drift.
- Stick inte in föremål under enheten.
- Blockera inte ventilationshålen ovanpå enheten. Placera inte någonting närmare än 1 meter ovanför apparaten eller enheten.
- Se till att det finns omkring 0,2 meter fri plats runt omkring enheten.

Dansk

Anbring ikke apparatet i et rack eller en boghylde, da dette kan bloke luftcirkulationen omkring apparatet. lagtag ligeledes følgende:

- Berør ikke oversiden af kabinettet under anvendelsen.
- Bloker ikke åbningerne i kabinettet under anvendelsen.
- Stik ikke genstande ind under apparatet.
- Bloker ikke ventilationsåbningerne ovenpå apparatet. Anbring ikke noget nærmere end 1 m over apparatets overside.
- Sørg for, at der er et frit område på omkring 0,2 m omkring apparatet.

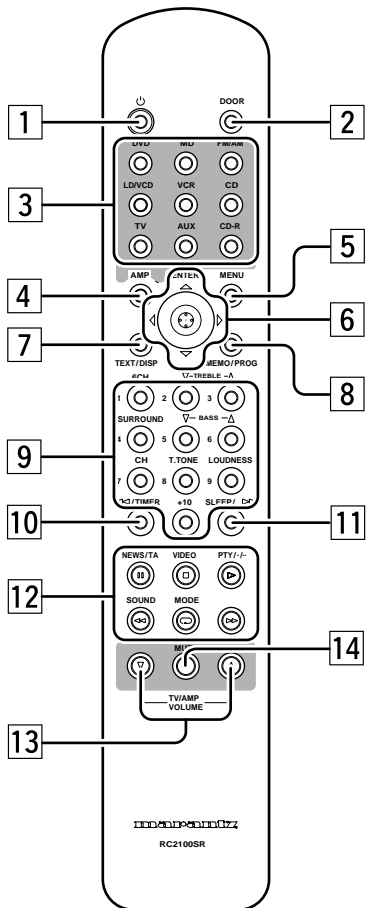
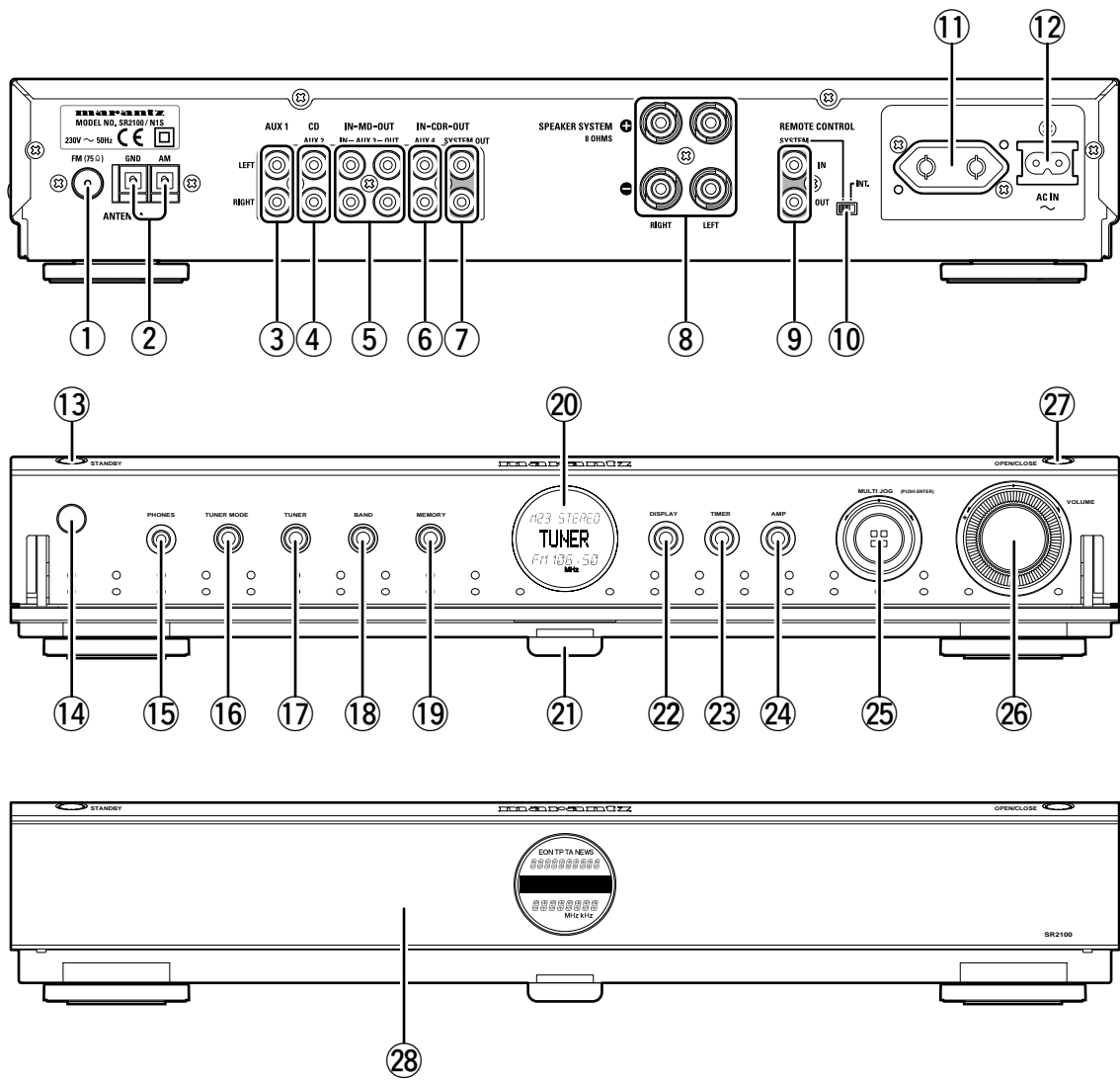

FOREWORD

This section must be read before any connection is made to the mains supply.

WARNINGS

- Do not expose the equipment to rain or moisture.
- Do not remove the cover from the equipment.
- Do not push anything inside the equipment through the ventilation holes.
- Do not handle the mains lead with wet hands.

EQUIPMENT MAINS WORKING SETTING

Your Marantz product has been prepared to comply with the household power and safety requirements that exist in your area. SR2100 can be powered by 230 V AC only.

IMPORTANT: (FOR UK VERSION)

This apparatus is fitted with an approved moulded 13 Amp plug. To change a fuse in this type of plug proceed as follows:

1. Remove fuse cover and fuse.
 2. Fix new fuse which should be a BS1362 13A, A.S.T.A. or BSI approved type.
 3. Refit the fuse cover.
- If the fitted plug is not suitable for your socket outlets, it should be cut off and an appropriate plug fitted in its place.
- If the mains plug contains a fuse, this should have a value of 13A. If a plug without a fuse is used, the fuse at the distribution board should not be greater than 5A.

Note:

The severed plug must be destroyed to avoid a possible shock hazard should it be inserted into a 13A socket elsewhere.

HOW TO CONNECT A PLUG

The wires in the mains lead are coloured in accordance with the following code:

BLUE—"NEUTRAL" ("N")
BROWN—"LIVE" ("L")

1. The BLUE wire must be connected to the terminal which is marked with the letter "N" or coloured BLACK.
2. The BROWN wire must be connected to the terminal which is marked with the letter "L" or coloured RED.
3. Do not connect either wires to the earth terminal in the plug which is marked by the letter "E" or by the safety earth symbol or coloured green or green-and-yellow.

Before replacing the plug cover, make certain that the cord grip is clamped over the sheath of the lead — not simply over the two wires.

COPYRIGHT

Recording and playback of any material may require consent. For further information refer to the following:

- Copyright Act 1956
- Dramatic and Musical Performers Act 1958
- Performers Protection Acts 1963 and 1972
- any subsequent statutory enactments and orders

ABOUT THIS USER GUIDE

Refer to the figures on page iv of this user guide. The numbers on the figures correspond to those in the text. All references to the connections and controls that are printed in **BOLD** type are as they appear on the unit.

PRECAUTIONS

The following precautions should be taken when operating the equipment.

GENERAL PRECAUTIONS

When siting the equipment ensure that:

- the ventilation holes are not covered;
- air is allowed to circulate freely around the equipment
- it is on a vibration free-surface;
- it will not be exposed to interference from an external source;
- it will not be exposed to excessive heat, cold, moisture or dust;
- it will not be exposed to direct sunlight;
- it will not be exposed to electrostatic discharges

Never place heavy objects on the equipment.

If a foreign body or water does enter the equipment, contact your nearest dealer or service centre.

Do not pull out the plug by pulling on the mains lead, hold the plug. It is advisable when leaving the house, or during a thunderstorm, to disconnect the equipment from the mains supply.

FEATURES

- Easy operation with remote control bus in SYSTEM mode operation
- Top-end model of the Marantz AV system
 - This model has a very slim shape and a height of 68 mm. All buttons, with the exception of the power and door open/close buttons, are concealed behind a front flap.
- High power output of 50W + 50W (DIN, into 8 ohms)
 - The discrete configuration possesses a high level of reliability.
- Door open/close mechanism operate both by switch and remote control
- 50-Station random preset tuner
 - Station names consisting of 8 characters can be stored together with the frequencies.
- RDS (Radio Data System) compatibility
 - PTY (Programme Type) Auto Seek
 - PS (Programme Service name) Display
 - TA (Traffic Announcement) Seek
 - TP (Traffic Programme) Seek
 - EON (Enhanced Other Network) Seek for TA and NEWS
- Independent/System operation switch
 - This unit can be operated as a system component in combination with the CD-R and DVD players from the Marantz AV system.
- 3-Program Timer/Sleep Timer
- Stylish New LCD (Liquid Crystal Display) Panel with Backlight
 - The New LCD panel backlight can be controlled with dimmer control.

CONNECTIONS

- **Connection of Remote control Bus: For Marantz AV system (DR2100, DV2100)**

This unit is equipped with the remote control bus function. Connecting it to Marantz AV system components equipped with REMOTE CONTROL jacks, such as a CD-R player (DR2100) and DVD player (DV2100), means that these components can be remote controlled from this unit (SR2100).

Connect the REMOTE CONTROL jacks of this unit to the REMOTE CONTROL jacks of another component using RCA-type pin lead provided.

To operate the SR2100 in the SYSTEM mode, the leads from the other components must be connected to the SR2100.

The lead from OUTPUT terminal of other component is connected to INPUT terminal of the SR2100. Please refer below.

Note:

If the component connected with the REMOTE CONTROL jacks has an **INT/EXT/SYSTEM** switch on the rear panel, set the switch to **SYSTEM** position.

- **Connection of Remote control Bus: For Marantz Models or without connecting any component (Single use)**

This unit is equipped with the REMOTE CONTROL bus function. By connecting it to Marantz system components equipped with remote control jacks, such as a CD player and MD player, these components can be remote controlled from this unit. The system control switch must be set to **INT** position for single use (no connection to other components).

Connect the REMOTE CONTROL jacks of this unit to the REMOTE CONTROL jacks of another component using RCA-type pin lead provided. Please refer below.

Note:

If the component connected with the REMOTE CONTROL jacks has an **INT/EXT** switch on the rear panel, set the switch to **EXT**.

- **Connection of Remote control Bus: For use in combination with Marantz AV system**

If you connect this unit to the Marantz AV system component, the system control switch must be set to **SYSTEM** position.

If other components which are not Marantz AV system are connected, the system control switch must be set to **INT** position.

Therefore, components other than Marantz AV system are controlled by their own remote controls.

Connect the REMOTE CONTROL jacks of this unit only to the REMOTE CONTROL jacks of Marantz AV system, using RCA-type pin lead provided. Do not connect the remote control cable to the other models. Please refer below.

- **Connection of SYSTEM IN/OUT Bus: For Marantz AV system (DR2100, DV2100)**

- The SYSTEM IN/OUT terminal is for AUDIO signal input and output.

- To use the remote control in the SYSTEM mode (system control switch set to SYSTEM position), be sure to connect the AUDIO terminals of the SYSTEM IN/OUT jacks to those of the other component.

- You can also use the terminals AUX 1, 2, 3, 4 in the SYSTEM mode. These terminals are used with Marantz models or components of other brands. Please refer to the following figure. Be sure to set the system control switch to **SYSTEM** position.

Note:

If these components are to be stacked, always observe the stacking order shown in this illustration, that is, the receiver on top, the CD-R player in the middle and the DVD player on the bottom.

Be sure to set the main power switches of the DR2100 and DV2100 ON.

- **Connection of Audio IN/OUT: For other models**

The connections for audio inputs and outputs of other models are connected to the individual terminals, CD, CD-R, MD or AUX 1. Please refer to the figure on next page. In this situation, the system control switch must be set to **INT** position.

CONTROL BUTTON ON THE REMOTE CONTROL UNIT

1 Power switch

Press this switch to turn the power of the unit ON. If components of Marantz AV system are connected through the REMOTE CONTROL bus, this will turn these components ON. Press this switch again to turn the unit OFF, and the unit enters standby mode.

2 DOOR button

Press this button to open or close the door. If components of Marantz AV system are connected through the remote control bus, the DOOR button allows the doors on the system components to be opened or closed.

Note:

The DOOR button is invalid if the components are not connected through the remote control bus or the system control switch is not set to SYSTEM position. (The system control switch is on the rear panel.)

3 Function buttons

There are FM/AM, CD, CD-R, MD, VCR, AUX, DVD, LD/VCD, and TV buttons. These buttons are used to select the source to be played or recorded.

To switch the input selector of the receiver, press the button twice.

4 AMP button

Press this button to switch to AMP mode of the remote control and receiver.

5 MENU button

This button is used to turn ON the menu system of other components.

6 Cursor buttons and ENTER button

These buttons are used to move the cursor of the menu system of the components, in the same way as the receiver's JOG control, left, right and enter.

7 TEXT/DISP (display) button

This button is used to display the text or other information from the DVD, CD, CD-R and MD.

Pressing this button can also indicate the present time on the main unit or display information from the RDS data system. To change the backlight of the LCD to dimmer or normal, press this button for more than 3 seconds.

8 MEMO/PROG (program) button

This button is used to store the preset memory of the tuner and clock or to program CD, DVD, CD-R tracks.

9 Numeric (ten keypad) or amp control button

These buttons are used to select the preset memory of the tuner, or to control the BASS, TREBLE and LOUDNESS of the receiver.

Please refer below. To switch to amp control mode, press the AMP button before pressing the numeric buttons.

Button	Numeric	Amp control
1	1	6CH Direct
2	2	TREBLE down
3	3	TREBLE up
4	4	SURROUND mode selection for PS2100
5	5	BASS down
6	6	BASS up
7	7	CHANNEL selection for PS2100
8	8	TEST TONE is activated (Only for PS2100)
9	9	LOUDNESS control is activated
0	0 or +10	No action

10 ◀◀ /TIMER program

This button is used to decrease the number on the tuner preset memory or return to previous tracks on CD, DVD, or CD-R.

To activate the timer program of the receiver in AMP mode, press this button.

11 ▶▶ /SLEEP timer

This button is used to increase the number on the tuner preset memory or advance to next track on CD, DVD, or CD-R.

To activate the sleep timer of the receiver in AMP mode, press this button.

12 Control buttons (PLAY, STOP, PAUSE, FF, REW, REPEAT mode)

By switching input source, these buttons can be used to operate the CD player, DVD player, CD-R, MD recorder and VCR, and can be used to operate the TV and tuner.

Please refer below.

Button	CD, DVD, CD-R, MD, VCR, LD/VCD	TV	Tuner
Play	Play	./.. Digit	PTY
Stop	Stop	Video	No output
Pause	Pause or still	OSD	NEWS/TA
FF	FF	CH-CALL	No output
Repeat mode	Repeat	No output	No output
Rew	Rew	SOUND	No output

13 TV/AMP VOLUME button

These buttons are used to change the volume for listening. Press the ▲ button to increase and the ▼ button to decrease the volume.

14 MUTE button

Press to mute the sound from the speakers. When this button is pressed, the speakers' sound level is muted and "MUTE" appears on the display. Pressing this button again cancels the muting function, and it can also be cancelled by pressing one of the function buttons.

This button is used to mute the sound level of the TV set when the selected function is TV.

OPERATION OF REMOTE CONTROL UNIT

1. REMOTE CONTROL

The distance between the transmitter of the remote control unit and the IR SENSOR of the SR2100 should be less than about 5 meters. If the transmitter is pointed to a direction other than the IR SENSOR or if there is an obstacle between them, remote control may not be possible.

Remote-controllable range

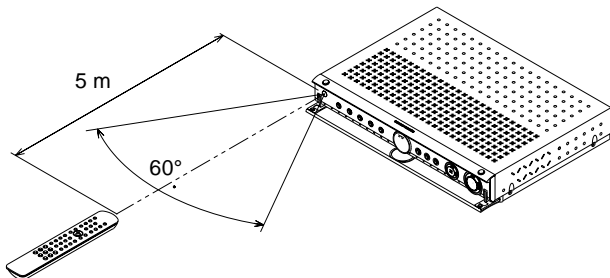

2. LOADING BATTERIES

The life of the batteries used with the remote control unit is about 6 months with normal use. Also be sure to replace batteries earlier when you notice that they are getting weak.

1. Remove the back cover.

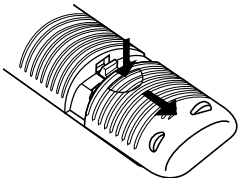

2. Insert the new batteries (AAA type) with correct (+) and (-) polarity.

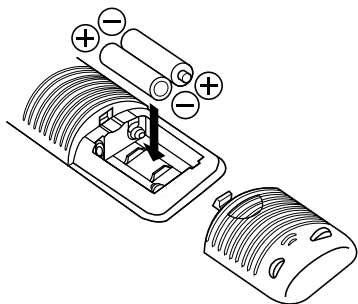

3. Close until it clicks.

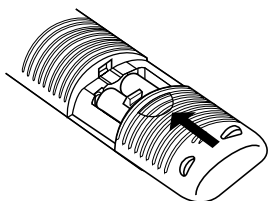

CONNECTORS AND CONTROLS ON THE MAIN UNIT

① Terminal for FM antenna, 75 ohms

For connecting an external FM antenna with a circular plug, or for connecting a cable network.

② Terminals for AM antenna and Grounding

To connect the supplied AM loop antenna, use the terminals marked "AM" and "GND".

In areas where the AM loop antenna gives unsatisfactory results, it is recommended that the receiver be connected to an outdoor antenna. Use the terminal marked 'AM' for this. A grounding lead can be connected to the terminal marked 'GND' to further reduce interference. In this case, it must be connected together with the supplied loop antenna.

③ AUX 1 Input jacks

Connect to the audio output jacks of the TV set, DVD player, etc.

④ CD (AUX 2) input jacks

Connect to the audio output jacks of a CD player. If the system control switch is set to SYSTEM position, AUX 2 can be selected with the AUX button or JOG control on the remote control or with the JOG control on the main unit.

⑤ MD (AUX 3) input/output jacks

Connect the IN jacks to the output jacks of a MD player, and the OUT jacks to its input jacks.

If the system control switch is set to SYSTEM position, AUX 3 can be selected with the AUX button or JOG control on the remote control or with the JOG control on the main unit.

⑥ CD-R (AUX 4) Input jacks

Connect to the audio output jacks of a CD-R player. If the system control switch is set to SYSTEM position, AUX 4 can be selected with the AUX button or JOG control on the remote control or with the JOG control on the main unit.

⑦ Output jacks (SYSTEM OUT)

Connect to the audio input jacks of a CD-R recorder. If the system control switch is set to SYSTEM position, these jacks must be connected to the SYSTEM IN jacks of DR2100 or DV2100.

⑧ SPEAKER SYSTEM terminals

Connect the left and right speaker leads, observing the + and – polarity of the leads and terminals.

⑨ REMOTE CONTROL jacks

Connect to a component equipped with remote control jacks. (Refer to page 3.)

⑩ System control switch

This switch selects the system operation mode. Set to SYSTEM position when the unit is being used in combination with a CD-R (DR2100) or DVD (DV2100). If your component is not capable of system connection, set this switch to INT position.

⑪ AC OUTLET (UNSWITCHED)

Connect the power cords of components such as a CD-R player (DR2100) or DVD player (DV2100) to this outlet.

Note:

The DR2100 and DV2100 also have AC OUTLET, so they can be run from the SR2100 without being plugged into a household outlet.

Please refer to page 3, "System Connection".

⑫ AC inlet

Connect the supplied power cord. After connection, plug the power cord into an AC 230V household outlet.

⑬ STANDBY/power switch and indicator

Press to turn power ON and press again to switch to STANDBY mode. The indicator lights GREEN when power is ON, and lights RED when in STANDBY mode. The indicator lights ORANGE when the timer program is set during STANDBY mode.

⑭ Infrared sensor

The infrared signal from the remote control unit enters the unit through this window. To operate the unit with the receiver door open, point the remote control infrared signal transmitter toward this window.

⑮ PHONES jack

For connecting a pair of stereo headphones. When the headphones are connected to this jack, the speaker sound is turned off.

Note:

If the headphones are connected to this jack, the receiver door does not close even if you press the door CLOSE button or the unit is in standby mode.

⑯ TUNER MODE button

Press to change FM broadcasting to MONO or STEREO.

The "MONO" indicator lights up on the display in MONO position, the "AUTO" indicator lights up when there is no signal and "STEREO" lights up when a stereo signal is received.

⑰ TUNER button

Press to select FM or AM tuner when another source is selected and select the JOG operation for TUNER selection. Use this button to select the JOG operation for a scan of frequency, preset memory or RDS mode. The TUNER button changes modes as below.

FREQUENCY mode: To scan tuning by frequency by JOG control.

PRESET mode: To scan tunings in the preset memory by JOG control.

RDS mode: To select RDS control (PTY, TP, TA, and EON SEEK) by JOG control.

Please refer to page 10 for tuner operations.

⑱ BAND button

Press to change the reception band to FM, MW or LW.

⑲ MEMORY button

Press to set the preset memory of the tuner, clock time or timer program. Please refer to the tuner and timer operations.

⑳ LCD (Liquid Crystal Display) panel

This panel shows information on the status of the unit.

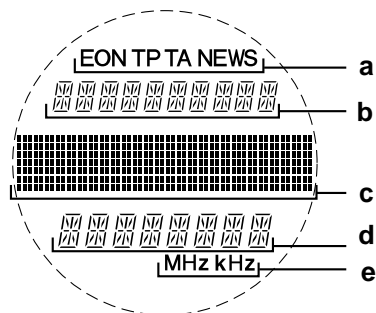

- a: RDS indicator
EON: EON indicator
TA: TA indicator
TP: TP indicator
NEWS: NEWS indicator
- b: Preset station number and FM broadcast mode (STEREO) indicator, etc.
- c: Selected source indicator, etc.
- d: FM 106.50 Band and frequency indicator.
- e: MHz (kHz) Unit of frequency

㉑ Infrared sensor

The infrared signal from the remote control enters the unit through this window. To operate the unit with the receiver door closed, point the remote control infrared signal transmitter toward this window.

㉒ DISPLAY button

Press to change the display for information such as clock time or data in RDS mode.

Press this button for more than 3 seconds to change the brightness of the LCD backlight to dimmer or normal,

㉓ TIMER button

Press this button to program and check the timer program. Please refer to page 14 for timer program operation.

㉔ AMP button

The JOG control can be used in the TUNER, AMP or TIMER modes. Press to change the mode of JOG control to AMP mode.

5 seconds after the previous JOG operation is finished, the mode of JOG control will return to AMP mode automatically. You can also use this button to return to AMP mode immediately. The function of JOG control in AMP mode is changed as follows:

SOURCE select mode: To select input mode.

BASS control mode: Tone control (Low frequency)

TREBLE control mode: Tone control (High frequency)

The AMP mode is used for tone control (BASS/TREBLE) and to change also source for JOG control.

㉕ JOG control

The JOG control can be used in the AMP, TUNER and TIMER modes. Details of operation are as follows:

AMP mode: Source select (Usual setting)

Bass control (AMP button is pressed once)

Treble control (AMP button is pressed twice)

TUNER mode: Frequency scan mode (last operation is memorised)

Preset memory scan mode (last operation is memorised)

RDS mode selection for PTY SEEK, TP SEEK, TA SEEK, EON SEEK (last operation is memorised)

TIMER mode: Program and confirm timer setting

For more detail, refer to the respective page.

㉖ VOLUME control

To increase or decrease sound level. To increase the sound level turn clockwise, and to decrease turn counter-clockwise. Each time the unit is turned ON, the sound level is indicated first.

㉗ Door OPEN/CLOSE button

To open or close the door, press this button. In SYSTEM mode (system control switch set to SYSTEM position), the doors of components which are connected to the REMOTE CONTROL terminal (DR2100 and DV2100) are controlled simultaneously by the remote control.

Note:

If the door is opened manually in standby mode, the unit will turn power ON.

㉘ Front panel door

This door can be operated by door OPEN/CLOSE button.

When the unit is turned into standby mode, this door closes automatically.

WHAT IS THE SYSTEM CONTROL?

The remote control system can be used to control Marantz system components equipped with REMOTE CONTROL (Bus) jacks and SYSTEM (Bus) jacks, such as DR2100 and DV2100. An example procedure for system operation is described below. Here, we take as an example the connection of a CD-R player (DR2100) to this receiver (SR2100) through the REMOTE CONTROL jacks. (CD playing using a CD-R player) (The numbers of controls and buttons on the main unit are enclosed in ○, and those on the remote control are enclosed in □.)

1. Press the power switch ⑬ or ① to turn the receiver power ON.
2. All the components connected to the REMOTE CONTROL jacks are turned ON.
3. Press the CD button twice to select CD as a source and set the remote control to CD mode.
4. Press the "5" of the numeric button to select track number 5 of the CD.
5. Press the **PLAY** button (▶) or the play button of the DR2100 to play the CD.
6. The CD-R player (DR2100) starts to play the CD.
7. Press the **VOLUME** buttons ⑬ or turn the **VOLUME** control ⑆ to adjust the listening volume.
8. Press the **STOP** ⑫ button to stop the CD.
9. Press the power switch ⑬ or ① to turn the power off and into the standby mode.
10. The SR2100 receiver and all the components connected to it are turned OFF.

FEATURES OF SYSTEM CONTROL

1. **Synchronized power ON/OFF**
By switching the power switch ⑬ or ①, you can turn the CD-R player and DVD player connected through the REMOTE CONTROL bus connection ON or OFF.
2. **Synchronized door open/close**
Pressing the DOOR button of the remote control opens or closes the doors of the components in the system.
3. **Auto source selection**
When the CD in the DR2100 starts playing by pressing the play button on the DR2100, the SR2100 receiver will change source automatically and stop playing another source component.
4. **Simple connection**
The system can be connected very easily with a small number of cables.

Note:

If the SYSTEM bus connection has been made, it is possible to dub a CD to CD-R in the DR2100 while playing another source (Tuner or DVD, etc.) Please refer to the instruction manual of the DR2100 for more details.

5. A large number of connectable sources in AUX 1, 2, 3, 4, without the SYSTEM bus (connectable to the DR2100 and DV2100 units). A total of 7 sources (including Tuner).

NO SYSTEM CONNECTION

When you use this unit in combination with other Marantz components for which a system connections is not possible, or components of other brands, you can use them independently by setting the system control switch to INT position.

To operate the RC2100SR remote control, it is necessary to connect to Marantz components to REMOTE CONTROL bus. Please refer to page 3 for No System Connection.

Connection for system control (System switch set to INT position)

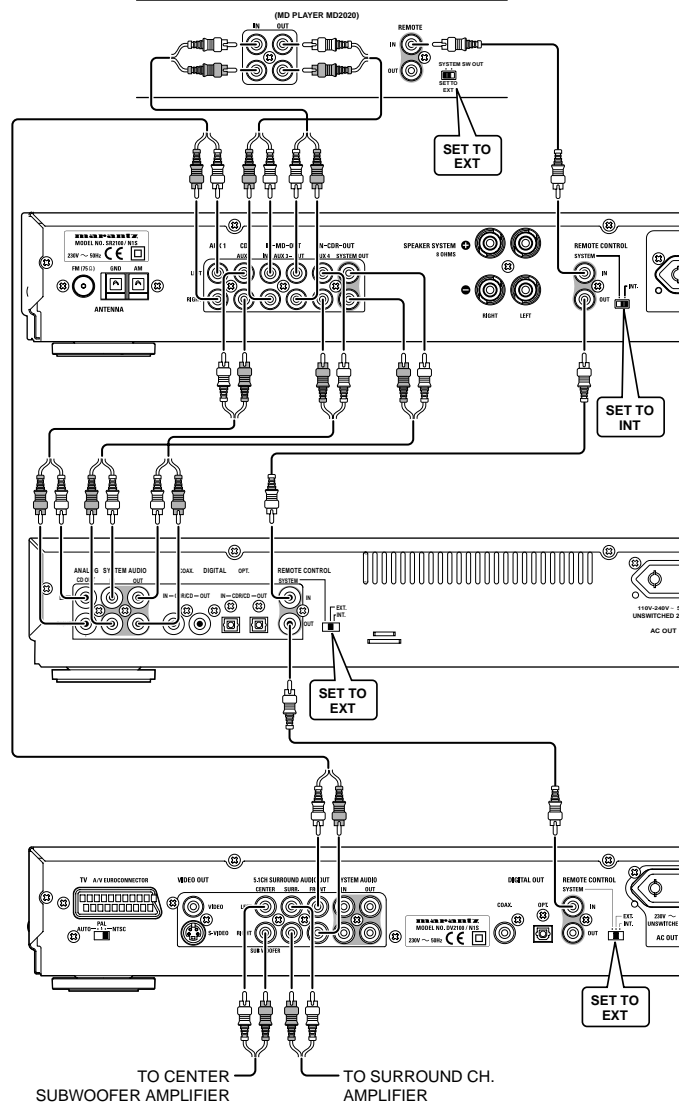

BASIC OPERATIONS

PLAYING A PROGRAM SOURCE

NORMAL PLAY

1. Press the **power** switch **13/1** to turn the power ON. (The display briefly indicates the volume level, and you can confirm it at this time.)
2. Press the optimum function button or turn **JOG** control **25** in the **SOURCE** select mode to select the source to be played. Please refer to the next table.

Source to be played	Function button control on the remote	JOG control on main unit
FM or AM (MW, LW)	FM/AM	TUNER
CD-R player (DR2100)	CD for CD, CD-R for CD-R (*1)	CD-R (*1)
MD player	MD (*1, *2)	MD (*1)
DVD player (DV2100)	DVD (*1, *3)	DVD (*1, *2)
AUX 1, 2, 3, 4 (TV game, etc.)	AUX (press each time) (*4)	AUX 1, 2, 3, 4 (*4)

3. Start playing the source component. Adjust the listening volume with the **VOLUME** control **26** or **VOLUME** buttons **13**. Adjust the tone control (BASS/TREBLE) by **JOG** control **25** after pressing the **AMP** button **24** or with the **numeric** buttons 2/3/5/6 **9** on the remote control after pressing the **AMP** button **24**. The source selector will change players automatically in **SYSTEM** mode.

Note:

The SR2100's CPU (Microprocessor) only detects the components which use the system connection in **SYSTEM** mode (when the system control switch set to **SYSTEM** position). The SR2100's source selector cannot make a selection without detecting the component. Component which is not capable of system connection will not be displayed in **SYSTEM** mode.

As of 2000, a system connection with this unit can only be made using the DR2100 and the DV2100. Please set the system control switch to **INT** position when connecting components of other models, or connect these components to AUX 1, 2, 3, 4 in **SYSTEM** mode.

*1

The source selector cannot select a source that is not connected to the **REMOTE CONTROL** jacks when the system control switch is set to **SYSTEM** position. Therefore, when the DR2100 is connected to the SR2100, it is necessary to connect to the **REMOTE CONTROL** jacks and set the system control switch to **SYSTEM** position.

*2

As of year 2000, no MD player capable of system connection with this unit has been released. To use the Marantz MD2020 or CM6000 or an MD player of another brand, set the system control switch to **INT** position or connect to AUX 2 in **SYSTEM** mode. (You can change the source name AUX 2 to MD. Please refer to page 16, RE-NAME function.)

*3

The source selector cannot select the DV2100 without a **SYSTEM** connection, so it is necessary to connect the SR2100 **REMOTE CONTROL** jacks to the DV2100 **SYSTEM OUT** jacks and set the system control switch to **SYSTEM**.

*4

The source selector can select AUX 2, 3, 4 in **SYSTEM** mode. To select these sources by remote control, press the **AUX** button twice or more until the desired source name is displayed. (You can change the source name of AUX 1, 2, 3, 4 to another name. Please refer to page 16, RE-NAME function.)

TO ADJUST TONE CONTROL (BASS AND TREBLE)

The Bass and Treble frequencies can be controlled by **JOG** control. Details of operation are as follows.

By Main Unit

1. Press the **AMP** button **24** once or twice to set the mode of **JOG** control **25** to **TONE** control mode. "**BASS**" or "**TREBLE**" is displayed. (Fig.1)
2. Within approx. 5 seconds, turn the **JOG** control **25** to the left to decrease, or to the right to increase step by step. You can both increase and decrease the tone for 7 step. (Fig.2) To cancel the tone adjustment operation, press the **ENTER** button **25**.

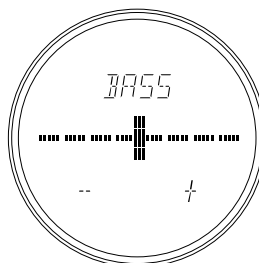

Fig.1

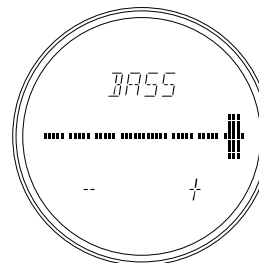

Fig.2

By Remote control

1. Press the **AMP** button **4** to set the ten keypad to **AMP** mode.
2. Press the **BASS** (5, 6) or **TREBLE** (2, 3) button **9** to increase or decrease directly.

TO RECORD SOUND ONTO A CD-R OR MD:

Use the following procedure to record, for example, a CD onto a CD-R while listening to the CD.

1. Select the **CD** function by remote control or **JOG** control.
2. Play the CD in the CD-R player (DR2100).
3. Operate the CD-R to record the CD onto CD-R. The recorded sound will be the same as that reproduced through the speakers.

TO DUB FROM A CD TO CD-R WHILE LISTENING TO THE TUNER, ETC.:

The SR2100 can dub a CD while you are listening to another source in **SYSTEM** mode (system control switch set to **SYSTEM** position), when used in combination with the DR2100.

For details of operation, please refer to the instruction manual of the DR2100.

TUNER OPERATION

TO LISTEN TO THE TUNER

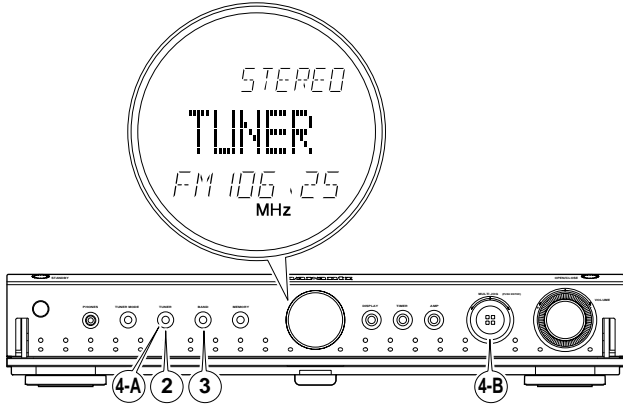

1. Press the **power** switch (13/1) to turn the power ON.
2. Press the **FM/AM** (3) button or the **TUNER** button (17).
3. To select the band of reception, press the **BAND** button (18) or the **FM/AM** (3) button on the remote control.
4. Press the ◀◀ (rewind) or ▶▶ (fast forward) button (12) to scan the frequency by remote control.

Scan frequency on the main unit as follows:

A: Press the **TUNER** button until the display indicates "FREQ" to set the mode of **JOG** control (25) to frequency scan mode.

B: Turn the **JOG** control (25) clockwise to increase or counter-clockwise to decrease the frequency.

C: To start the auto scan tuning, turn the **JOG** control (25) or press and hold ◀◀/▶▶ button on the remote control for a while continuously.

Auto scan tuning stops automatically when a broadcasting station is tuned in, and the "TUNED" or "STEREO" display lights up.

5. Adjust the volume with the **VOLUME** control (26) or **VOLUME** buttons (13). To receive sound in monaural, press the **TUNER MODE** button (16) or the **MODE** button (12) so that the "MONO" lights up.

Note:

Muting of the FM band is not activated when the tuner mode is set to MONO. Please take care with the volume.

A: Select the preset number by turning the **JOG** control (25) right for up or left for down and press **MEMORY** (19) button or **ENTER** button of **JOG** control (25).

B: Select the preset number by directly entering it with the numeric buttons on the remote control.

In this case, entering two-digit is required for all numbers. (e.g. for 1 to 9, press 01 to 09)

Auto preset memory (main unit only)

This allows a band to be scanned automatically, a station with good reception to be found and to be stored in the preset memory.



1. Select the desired band and frequency.
2. While holding down the **MEMORY** (19) for more than 3 seconds. The auto preset memory operation starts. The display indicates "AUTOMEMO" and "AUTO" starts to blink. Auto scanning will then start from the low-end of the band.
3. When a station is received, scanning pauses for 5 seconds. In this period, you can change TUNER mode to STEREO or MONO.
4. If no button is pressed during 5 seconds, the frequency being received is stored. If the **JOG** control is turned again within 5 seconds, scanning restarts and the frequency being received is not stored in the memory.
5. When up to 50 stations have been preset or scanning of all bands has been finished, the auto preset memory function automatically stops and the unit tunes to the frequency where auto scanning start.

To stop in mid-operation, press **ENTER** of **JOG** control (25) or the "0" button on the remote control.

PRESET MEMORY OPERATION

The SR2100 receiver can store up to 50 stations selected in the FM, MW and LW bands.

The preset memory function allows frequency, receiving mode (STEREO or MONO) and also station name to be stored in the memory. The preset memory can be stored in two ways:

Manual preset memory

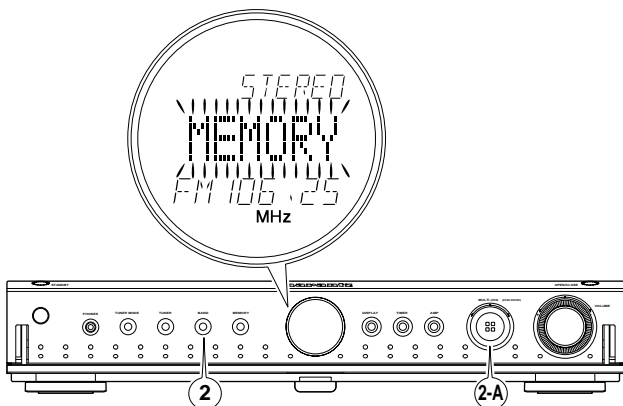

1. Select the desired station, referring to "TUNER OPERATION".
2. Press the **MEMORY** (19) or **MEMO** button (8). The **MEMORY** indicator will blink for approx. 5 seconds. During this period, select the preset number with one of the following procedures.

ADVANCED OPERATIONS

STATION NAME PRESET

The station name preset function allows the name of each preset channel to be entered using alphabetic and numeric characters. Before the station name preset operation, store stations with the preset memory operation described on the previous page. The operation procedure is as follows:

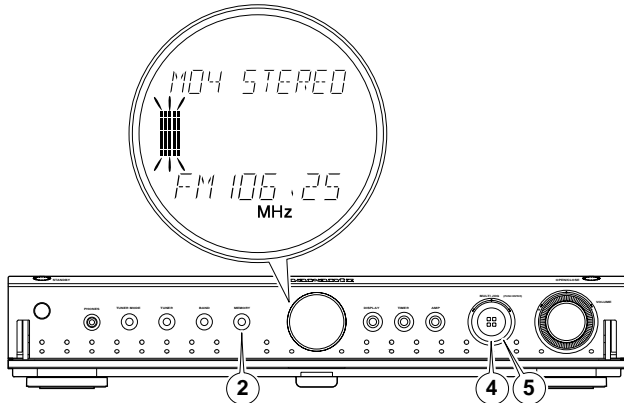

1. Tune to the desired preset channel. (It is not available if no station is preset.)
2. Press and hold the **MEMORY** 19 or **MEMO** button 8 for more than 3 seconds.
3. The extreme left column of the station name indicator will flash, indicating character entry ready status.
4. When the **JOG** control 25 is turned right or the right cursor button is pressed, alphabetic and numeric characters will be displayed in the following order:
A → B → C ... Z → 1 → 2 → 3 ... 0 → space → ' → , → / → + → - → A
← Left Right →
5. After selecting the first character to be entered, press the **ENTER** button of **JOG** control 25. The entry in this column is fixed and the next column starts to flash. Fill all columns, and make sure all characters are flashing.
Press the **ENTER** button of **JOG** control 25 to confirm the entry.

Note:

To finish entering during operation, press the **ENTER** button for more than 3 seconds.

To change the character in the previous column, turn the **JOG** control and press the **ENTER** button.

RECALLING A STATION FROM THE PRESET MEMORY

1. For direct selection, press numeric button . If you want to select a 1-digit number it should be preceded by 0, for example "05".
2. It is possible to select a station by using the ◀◀ 10 or the ▶▶ button 11 of the remote control, or by turning the **JOG** control 25 left or right on the main unit in PRESET mode. To change the mode of the **JOG** control 25 to PRESET mode, press the **TUNER** button 17 on the main unit until "PRESET" appears in the display.

CLEARING THE PRESET MEMORY

The preset memory contents can be cleared with the following procedure.

1. Recall the preset number to be cleared by the way of the previous page.
2. Press the **MEMORY** 19 or **MEMO** button 8, press 0 button 9 on remote control more than 3 seconds. For example, when you want to clear preset number 12, "CLEAR 12" is displayed.

COPYING THE PRESET MEMORY

The preset memory can copy to other preset number.

1. Recall the original preset station.
2. Press the **MEMORY** 19 or **MEMO** button 8, and turn the **JOG** control 25 until the desired preset number is displayed, or press the desired number on the **ten keypad** 9.
3. Press the **ENTER** button 6 to complete entry.

RECEPTION OF RDS BROADCASTING

The SR2100 receiver provides the following functions for use with the RDS (Radio Data System).

PTY (Program Type) Auto Seek

Automatic searching only for stations broadcasting the specified type (genre) of programs.

RADIOTEXT display

Some RDS stations broadcast RADIOTEXT, which contains additional information on the station and programme being broadcast.

RADIOTEXT information appears as 'running' text on the display. RADIOTEXT is transmitted character-by-character by the radio station. As a result, it may take some time until the entire text has been received.

PS (Programme Service name) display

The name of the station being tuned is displayed automatically.

CT (Clock Time) display

The clock time is displayed from the broadcasted data. It is local area time. This time can be copied to the unit's clock display. Please refer to page 16, "CT to CL".

RDS Display

When a receiver is tuned to an FM station that is transmitting RDS data, the display will automatically show the station name or RDS TEXT.

To change the display, press the **DISPLAY** button 22/17 in TUNER mode. The display will change as follows:

PS (Programme Service) → RT (Radio Text) → PTY (Programme Type) → CT (Clock Time) → PS

Note:

To display the clock (not RDS CT), press the **AMP** and **DISPLAY** button in TUNER mode.

When no RDS station is received or the received station does not broadcast the required data, the display will indicate as follows:

"NO NAME" for PS, "NO TEXT" for RADIOTEXT, "NO CT" for CT.

PTY AUTO SEEK

The SR2100 receiver automatically searches for stations transmitting any of 29 different programme types. To search for a PTY, follow these steps:

By remote control

1. Press **PTY./..** button 12 on the remote control until "PTY SEEK" appears on the display. If you press the **ENTER** button of **JOG** control 6, the current station's program type will be displayed when the RDS data is present, or the currently selected PTY group will be displayed blinking if no station or the RDS data is present.
2. To change to a new programme type, turn the **JOG** control 6 left or right until the desired PTY is shown in the display.
3. To select a specified program type, use the **ten keypad** 9 on the remote control by entering the corresponding number in the table on the following page.
4. Once the desired PTY group or type has been selected, press the **ENTER** button of **JOG** control 6 while the display is blinking (approx. 5 seconds). The PTY Auto search will start, and the tuner will detect all station broadcasting RDS whose PTY information corresponds to the selected choice.
5. The auto search will stop at a station with the specified PTY. To advance to the next RDS station, press the **ENTER** button 6 again within 5 seconds.
To cancel this function, turn the **JOG** control 6 left or right.

NUMBER	DISPLAY	PROGRAMME TYPE
1	POP	Pop Music
2	ROCK	Rock Music
3	MOR	M. O. R. Music
4	LIGHT	Light classical
5	CLASSIC	Serious classical
6	NEWS	News
7	AFFAIR	Current Affairs
8	INFO	Information
9	SPORT	Sport
10	EDUCATE	Education
11	DRAMA	Drama
12	CULTURE	Culture
13	SCIENCE	Science
14	OTHERS	Varied
15	OTHER	Other Music
16	WEATHER	Weather
17	FINANCE	Finance
18	CHILDREN	Children's programmes
19	SOCIAL	Social Affairs
20	RELIGION	Religion
21	PHONE IN	Phone In
22	TRAVEL	Travel
23	HOBBIES	Hobbies
24	JAZZ	Jazz Music
25	COUNTRY	Country Music
26	NATION	National Music
27	OLDIES	Oldies Music
28	FOLK	Folk Music
29	DOCUMENT	Documentary

- The auto search will stop at a station with the specified PTY. To advance to the next RDS station with the specified PTY, press the **ENTER** button **25** again within 5 seconds.
To cancel this function, press the **ENTER** button during scanning.

RDS SEEK BY JOG CONTROL

RDS MODE

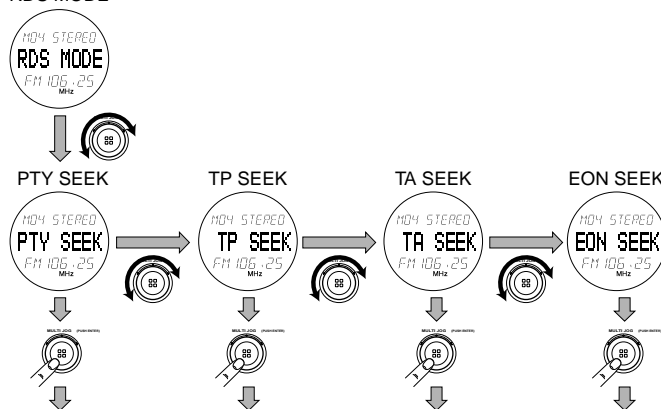

Start RDS function

TP (TRAFFIC PROGRAMME) SEEK

TP is the information of traffic programme in RDS. It is possible that the programme will be broadcasted with a TP flag. (But this is not always the case.) The TP SEEK function searches for this flag.

By remote control

- Press the **PTY./..** button **12** a few times until "TP SEEK" is shown on the display.
- Press the **ENTER** button **6** to start TP SEEK, and scanning will start.
- The tuner will stop scan when a broadcast is received and TP flag is detected. "TP" segment of the display lights up.

By main unit

- To change the JOG mode to RDS mode press the **TUNER** button **17** until the display indicates "RDS MODE" and press the **ENTER** button of **JOG** control **25**. Turn the **JOG** control **25** until the display indicates "TP SEEK" and press the **ENTER** button.
- The TP SEEK will start, and the tuner will stop scanning when a broadcast is received and TP flag is detected. "TP" segment of the display lights up.

TA (TRAFFIC ANNOUNCEMENT) SEEK

TA is the information of traffic announcement in RDS. TA is an audio announcement, and can be heard through the speakers.

By remote control

- Press the **PTY./..** button **12** a few times until the display indicates "TA SEEK".
- Press **ENTER** button **6** to start TA SEEK, and scanning will start.
- The tuner will stop scanning when a broadcast is received and TA flag is detected. "TA" segment of the display lights up. The tuner outputs traffic information through the speaker. Volume level can be adjusted.

By main unit

- To change the mode of **JOG** control **25** to RDS mode, press the **TUNER** button **17** until the display indicates "RDS MODE" and then press the **ENTER** button of **JOG** control **25**. Turn the **JOG** control **25** until the display indicates "TA SEEK" and press the **ENTER** button **25**.
- The TA SEEK will start, and the tuner will stop scanning when a broadcast is received and TA flag is detected. "TA" segment of the display lights up. The tuner outputs traffic information through speaker.

By main unit

- To change the mode of **JOG** control **25** to RDS, press the **TUNER** button **17** until "RDS MODE" appears on the display. Turn the **JOG** control **25** until the display indicates "PTY SEEK" and press the **ENTER** button **25**.

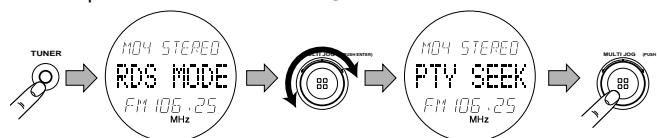

- The current station's PTY or the currently selected PTY group will be shown in the display. To select a PTY group, turn the **JOG** control **25** until the specified PTY is shown in the display and press the **ENTER** button **25**.

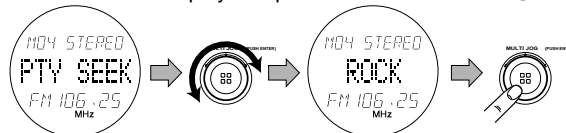

- The PTY Auto seek will start, and the tuner will detect each station broadcasting RDS whose PTY information corresponds to the selected choice.

EON (ENHANCED OTHER NETWORK) SEEK

The EON gives information from the other network of RDS. Information, such as TA, PTY, etc., can be obtained from other stations. The SR2100 has a special function for this EON data, as follows:

[Features of EON function]:

This feature automatically changes source from CD (for example) to tuner when desired programme (NEWS or TA) is received by the tuner.

For example, if while listening to a CD, the tuner receives NEWS or a traffic announcement program, the receiver will change its source from CD to tuner automatically. When the program is finished, the receiver's source will return to CD.

By remote control

1. To change the mode to tuner, press the **FM/AM** button [3], and the **NEWS/TA** button [12] among the control buttons.
2. The display indicates "EON SEEK". Press the **ENTER** button of **JOG** control [6].
3. The EON SEEK starts to scan, and will stop scanning when the tuner receives a station which has EON information. The "EON" indicator lights up. To advance to the next EON station with an EON flag, press the **ENTER** button [6] again within 5 seconds.
4. After the above procedure, press the **NEWS/TA** button [12] until the display shows the desired programme, NEWS or TA or NEWS and TA.
5. The desired program name lights up in the display (the NEWS or TA or NEWS and TA segments).
6. Change to the source you desire, for example CD, and play a CD.
7. The source will change automatically to tuner when the desired programme for EON information is detected. The NEWS or TA indicator blinks at this time. (The CD player will not stop)
8. The source selector will return to the previous source, CD, when the desired programme is finished.

By main unit

1. To change the mode of **JOG** control [25] to RDS mode, press the **TUNER** button [17] until "RDS MODE" is displayed and press the **ENTER** button [25] of **JOG** control. Turn the **JOG** control until the display indicates "EON SEEK" and press the **ENTER** button [25].
2. The EON SEEK starts to scan, and will stop scanning when the tuner receives a station which has EON information. The "EON" indicator lights up. To advance to the next EON station with the EON flag, press the **ENTER** button [25] again within 5 seconds.
3. After the above procedure, press the **NEWS/TA** button until the display shows the desired programme, NEWS or TA or NEWS and TA.
4. The display will show the desired program name (NEWS or TA or NEWS and TA).
5. Change to the source you desire, for example CD, and play a CD.
6. The source will change automatically to tuner when the desired programme for EON information is detected. The NEWS or TA segment indicator blinks at this time. (The CD player will not stop.)
7. The source selector will return to the previous source, for example CD, when the desired programme has finished.

CT (CLOCK TIME) IN RDS

The CT is clock time information from the RDS. This data can be copied to the present time by the CPU (microprocessor).

You can also turn this feature ON or OFF, and select a preset station when it is set to ON position. (The initial preset station is M01)

For detail of this feature, please refer to page 16, SPECIAL FUNCTIONS.

1. To display the RDS clock time, press the **DISPLAY** button [22/7].

Note:

When the RDS clock time is displayed, please check the local time in your country.

PRESENT TIME SETTING

Operation using the main unit

The initial clock display is "0:00". To operate the timer program, you must set the present time.

The following shows as an example how to set the time as 13:30, or 1:30 PM.

1. Press the **DISPLAY** button [22] except when "TUNER" is shown. The display changes to clock time.

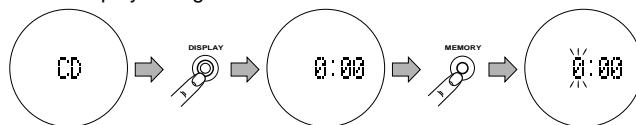

2. Press the **MEMORY** button [19]. The hour digit blinks in the display.
3. Turn the **JOG** control [25] to set the digits displayed to the left of the colon to "13", or "1".

Press the **ENTER** button of **JOG** control [25], to set the hour digits have been set. Then minute digit starts blinking.

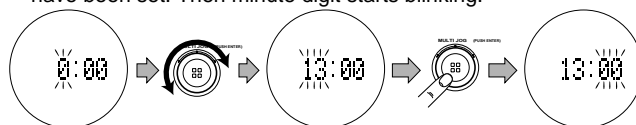

4. Turn the **JOG** control [25] to set the digits displayed in the minutes to "30".
5. Press the **MEMORY** button [19] to set the clock. The clock now starts.

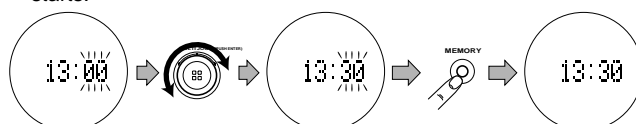

Note:

The 12-hour system can be set through the SPECIAL FUNCTION menu. Please refer page 16.

CORRECTING THE TIME

The displayed time can be corrected simply if it is done near the "00" minute of an hour.

The following example shows the displayed time, 13:58, is to be corrected to 14:00.

1. To change the display mode to clock, press the **DISPLAY** button [22]. The display indicates the clock.
2. Press the **MEMORY** button [19] for more than 3 seconds.
3. All digits start to blink.
4. Press the **MEMORY** button [19] to set the clock. The display changes to "14:00".

Note:

The displayed hour does not change if the minute figures displayed are between 00 and 29. If they are between 30 and 59, the displayed hour increases by one. (e.g: 12:29 → 12:00, 13:58 → 14:00)

PROGRAMME TIMER SETTING

The timer function is built into this receiver allows you to perform the following operations:

- Three timer settings at the same time: Program-1, Program-2 and Program-3;
- Setting of ON time and OFF time;
- Setting of source: The source can be selected from tuner preset number 1 to 50, CD, CD-R, MD, AUX and AUTO;
- It is possible to specify the track numbers of CD, CD-R, DVD or MD;
- It is possible to select recording or playing media;
- Setting of single operation (ONCE) or everyday operation (DAILY).

IMPORTANT:

The timer setting with track number specified can be used only when the system control switch is set to **SYSTEM** position except with using the tuner.

In the following procedure, each button should be pressed within 5 seconds after pressing the previous button.

1. Press the **power** switch (13/1) to turn the power of the unit ON.
2. Press the **TIMER** button (22/10). The display indicates "TMR PROG".

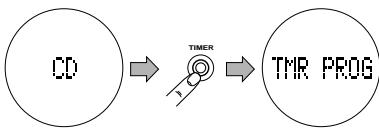

3. [SET THE ON TIME]

- 3-1. After a few seconds, "PROG-1" appears and starts blinking. Turn the **JOG** control (25) to select the desired timer program, and press the **ENTER** button (25). (If the selected program was used before, the details of the previous setting appear.)

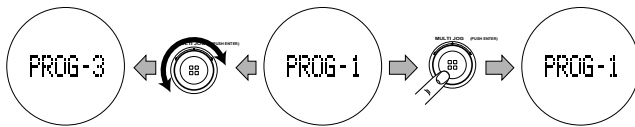

- 3-2. The display indicates "ON TIME" in the upper segment of the display, and the present time is displayed in the middle segment. (In this case, the present time is 10:05.)
- 3-3. "10" blinks. Turn the **JOG** control (25) to adjust the hour. To increase, turn to the right. To decrease, turn to the left. For example, set the hour to 12. (In this case, AM changes to PM.)



- 3-4. Press the **ENTER** button (25) to set the hour, and the minutes start to blink.
- 3-5. "05" blinks. Turn the **JOG** control (25) to adjust the minutes. For example, set the minutes to 30. (12:30)
- 3-6. Press the **ENTER** button (25) to set the minutes and all segments start to blink. When all segments blink, the time can be re-adjusted using the JOG control.
- 3-7. Press the **ENTER** button (25) to complete ON time setting. The display stops blinking.



4. [SET THE OFF TIME]

- 4-1. "OFF TIME" then appears in the upper segment of the display, and the time set as ON time (12:30) appears in the middle segment.
- 4-2. "12" blinks. Turn the **JOG** control (25) to adjust the time of timer stop. For example, "1".
- 4-3. Press the **ENTER** button (25) to set the time, and the minutes start to blink.

- 4-4. Turn the **JOG** control (25) to adjust the minute of timer stop, and press the **ENTER** button (25) to set the minute.



- 4-5. All segments blink in the display. The time can be re-adjusted by turning the **JOG** control (25) left or right.
- 4-6. Press the **ENTER** button (25) to complete the OFF time setting.



5. [SET THE MANUAL or AUTO] (only in SYSTEM mode)

- 5-1. The display indicates "AUTO" in the middle segment.

Note:

If "AUTO" is selected, the auto play function is activated, and it detects the source that can be played. For example, if a disk is set to CD side of DR2100, and no other player is set, the SR2100 will play the CD in DR2100 automatically. (The order of priority is CD → CD-R → DVD.)

- 5-2. If you want to play a specified source in AUTO mode, you have to set it.
- 5-3. If you want to select a source, you should select "MANUAL".

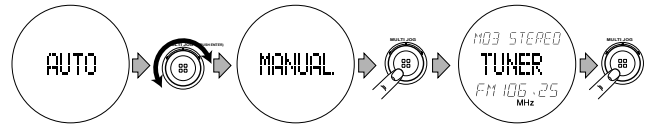

6. [SET TO MANUAL]

- 6-1. Turn the **JOG** control (25) to select "MANUAL" and press the **ENTER** button (25). The display indicates "MANUAL" for 2 seconds.
- 6-2. The display indicates the source name, for example CD. Turn the **JOG** control (25) to select the source and press the **ENTER** button (25). At this time, you need to select the track number of the playing medium. The display indicates "NUMBER XX".



- 6-3. Turn the **JOG** control (25) to select the track number. To increase the number, turn the **JOG** control (25) to the right, and to decrease, turn to the left. You can select number from 1 to 99. Please confirm the desired track number of the selected medium.
- 6-4. Press the **ENTER** button (25) to set the track number to be played. Next, select whether to record or not.

7. [SET TO "AUTO"]: This is available only when system control switch is set to SYSTEM position

- 7-1. Turn the **JOG** control (25) to select "AUTO" and press the **ENTER** button. The display indicates "AUTO" for 2 seconds. Next, set volume level.

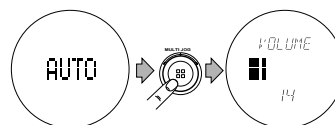

8. [SELECT WHETHER TO RECORD or NOT]: This is available only when system control switch is set to SYSTEM position

- 8-1. The display indicates "RECORDING?" in the upper segment and indicates "YES:FUNC" in the middle segment and indicates "NO:ENTER" in the lower segment. If you want to record, turn the **JOG** control (25) for the selected recording medium.
- 8-2. For example, if you want to record on CD-R, select "CDR" and press the **ENTER** button (25) to set recording to CD-R.
- 8-3. If there is no disc or a non-recordable disc in the CD-R player, the display will indicate "NG DISC".
If this is indicated, please check the recorder or the disc.



9. [SETTING THE VOLUME LEVEL]

- 9-1. Next, set the volume level. The display indicates the volume level.
- 9-2. Turn the **VOLUME** control (26) to set the sound level. The volume is adjusted to setting level when timer is activated.
- 9-3. The volume will fade up to the setting level when timer is activated, and fade out to the minimum level when timer is off.
- 9-4. Next set ONCE or DAILY.

10. [ONCE or DAILY]

- 10-1. The display indicates "ONCE", if you select it, the timer will activate only once.
- 10-2. Turn the **JOG** control (25) to select "DAILY", if you want to activate the timer once a day.
- 10-3. Press the **ENTER** button (25) to set the time of execution after selecting DAILY or ONCE. The display indicates the details of the timer programme one by one. Press the power button to set this unit in the timer standby mode.
The standby indicator lights up in AMBER to indicate the timer programme is set to ON.



11. [CONFIRM THE PROGRAMM]

- 11-1. Press the **TIMER** button (23) / (10). The display indicates "PROG-1". Turn the **JOG** control (25) to select the desired program number and press the **TIMER** button (23) again. If you want to erase this program memory, press the **ENTER** button at this time.
- 11-2. The display indicates the details of the timer programme one by one.
- 11-3. You can change the setting of selected program if necessary.

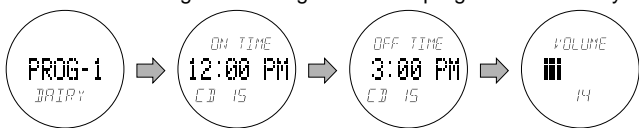

12. [NOT EXECUTING THE TIMER PROGRAMME] (REMOTE CONTROL ONLY)

The timer programs that have been set can be cancelled temporarily when they are not required.

- 12-1. When the timer indicator (the standby indicator lights up in AMBER) is displayed in standby mode, press the **TIMER** button (10). The colour of the standby indicator is changed from AMBER to RED, and the timer program will not be executed.
- 12-2. The timer program can be reactivated by pressing the **TIMER** button (10) again to display the timer indicator.

Note:

If all programs have been set (PROG-1, -2 and -3), it is not possible to cancel only one of them temporarily.

IMPORTANT:

- A: Be sure to set the present time before setting the timer.
- B: If the times set for two or three timer programs overlap, the timer will operate as follows:

- 1) If the ON time of one program comes after the ON time of the other program:
(Example)
In the case shown on the left, PROG-2 is not executed.



- 2) If the ON time of one program coincides with the OFF time of the other program:
(Example)

- In the case shown on the left, PROG-2 is also executed. However, there is a possibility that the OFF time of PROG-1 may be earlier than set. (For example, if you set an OFF time of 13:00, the program may actually finish at 12:55.) This is because the system takes some time to prepare the next function.

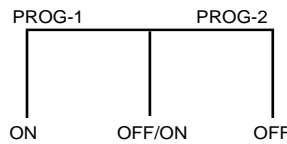

- 3) There is a priority between recording and playing programs when two or three timer programs start at the same time. The priority is recording, so that the program of normal playing cannot be executed.
There is a priority between PROG-1, -2 and PROG-3. The order of priority is PROG-1 → PROG-2 → PROG-3.

SLEEP TIMER SETTING (REMOTE CONTROL ONLY)

The sleep timer function allows the unit to be in standby mode automatically after a specified period of time.

- 1. While the power is ON, press the **SLEEP** button (11) in the AMP mode.
- 2. The display shows "SLEEP OF (OFF)" for 5 seconds
- 3. Press the **SLEEP** button (11) within 5 seconds. Each press changes the sleep timer period in the order 10 → 20 → 30 → 40 → 50 → 60 → 70 → 80 → 90 → OF (OFF).
- 4. When the desired period is displayed, release the **SLEEP** button (11). After that, setting of the sleep timer is completed and the count starts.
- 5. Press the **SLEEP** button (11) during the sleep timer count to display the remaining period in standby mode. To change the setting after the sleep timer has started the count, display the remaining time, press the **SLEEP** button (11) while the remaining period is displayed, and repeat steps 3 and 4 above.
- 6. To cancel the sleep timer, press **SLEEP** button (11) until "SLEEP OF (OFF)" is displayed.

SPECIAL FUNCTIONS

The special functions are used to the settings as follows.

1. Press the **MEMORY** button (19) and the **ENTER** button (25) of **JOG** control simultaneously. The display indicates "SP FUNC" and "DEMO".
2. Turn the **JOG** control (25) to select the function and press the **ENTER** button (25). Details of the operation are as follows.

DEMO MODE:

The DEMO mode is used for in store demonstrations. It operates as follows:

- Door OPEN and CLOSE with system components
 - LCD Back light dimmer turns on and off
1. Turn the **JOG** control (25) to select "DEMO" and press the **ENTER** button.
 2. Turn the **JOG** control (25) to select "DEMO ON" and press the **ENTER** button.
 3. Display shows "PUSH ENTER" and "DEMO".
 4. Press the **ENTER** button to execute the DEMO mode.
 5. To exit this function, press the **STANDBY** button (13).

Note:

This is executed automatically after a 15-minute passage of time if the unit is switched ON but is not being used.

BK LIGHT (BACKLIGHT):

This function adjusts the brightness of the backlight of LCD.

1. To change the brightness turn the **JOG** control (25) and press the **ENTER** button (25).

RE-NAME:

This function is used to change the name of the source for AUX 1, 2, 3 and 4 when the system control switch is set to **SYSTEM** position.

This function can only be used in SYSTEM mode.

1. Turn the **JOG** control (25) to select the source name to be cleared. Then, enter the special function.
2. Turn the **JOG** control (25) to select "RE-NAME" and press the **ENTER** button.
3. The display shows the existing source name, and the left column blinks. (You can change the names for AUX 1, 2, 3 and 4)
4. To select alphabetic and numeric characters, turn the **JOG** control (25) and press the **ENTER** button (25).

This operation is the same as the station name preset operation.

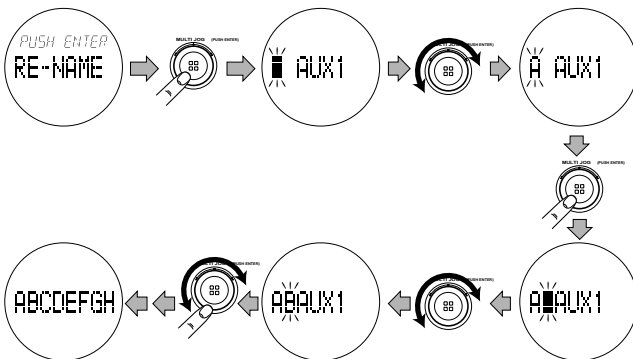

12H/24H: (12-HOUR SYSTEM/24-HOUR SYSTEM)

This function is used to change the clock mode to the 12-hour or 24-hour system.

1. To change this system, turn the **JOG** control (25) until the desired system is displayed and press the **ENTER** button (25).

MEMO CLR (MEMORY CLEAR)

This function is used to clear the preset memory and station name.

1. Turn the **JOG** control (25) to select "MEMO CLR", and press the **ENTER** button (25). "MEMO CLR" blinks and the memory is cleared.

CT TO CL (COPY CLOCK TIME DATA TO CLOCK)

This function is used to copy the clock time from RDS data to present time. The preset memory station picks up the CT data when it receives the RDS station. You can select a preset station to receive CT data.

1. Turn the **JOG** control (25) to select "CT to CL" and press the **ENTER** button (25). The display indicates "OFF".
2. To select the preset number, turn the **JOG** control and press the **ENTER** button. The initial setting of the preset number is M01. If you want to change the station to pick up CT data, turn the JOG the desired preset number is displayed.

Note:

The CT data is included in RDS data. However, there is a possibility that the station received does not transmit the same time as your local time. Please recheck your local time and the CT in RDS data.



EXIT

1. To exit this function press the **ENTER** button (25).

TROUBLE SHOOTING

Should faults occur, in many cases it is not necessary to consult your dealer or a Marantz technical service department.

On the basis of the following checks you will be able to rectify a number of faults yourself without difficulty.

If the fault cannot be remedied after the following checks, please consult your dealer or nearest Marantz service agent.

Sound comes from only one side.

- Check the connections of the loudspeaker which is not working.
- Check the connections between the sound source and the receiver.
- If using headphones, check that the plug is properly inserted into the jack.

There is hum, buzz or howl during recording or playing.

- Are the connection plugs pushed far enough into the jacks?

You cannot hear anything, and no indicator lights up.

- The receiver is not turned ON.
- The receiver is not connected to the mains power outlet.
- The mains power outlet is not live.

You cannot hear anything, but an indicator lights up.

- Are the function buttons in the correct positions?
- Is the selected sound source functioning properly?
- Is the volume control high enough? Do not keep it in the maximum position! The display indicates the volume level at the moment the power is turned ON.
- Are the loudspeakers connected properly?

The recording is unsuccessful.

- Is the signal source operated correctly?

The remote control is not working.

- Check that the batteries of the remote control unit are not exhausted.
If they are, replace them with two new batteries.

Easy operation is not working.

When the CD or other component starts playing, the receiver changes source automatically. If this function is not working –

- Check that the system control switch on the rear panel is set to SYSTEM position
- Check the connections of the remote control bus in SYSTEM mode (the system control switch set to SYSTEM position).

Please refer to **CONNECTION OF REMOTE CONTROL bus** page 3.

CARE AND MAINTENANCE

The section describes the care and maintenance tasks that must be performed to optimize the operation of your Marantz equipment.

CLEANING OF EQUIPMENT EXTERNAL SURFACES

The exterior finish of your unit will last indefinitely with proper care and cleaning. Never use scouring pads, steel wool, scouring powders or harsh chemical agents (e.g., lye solution), alcohol, thinner, benzene, insecticide or other volatile substances as these will mar the finish of the equipment. Likewise, never use cloths containing chemical substances. If the equipment get dirty, wipe the external surfaces with a soft, lint-free cloth.

If the equipment becomes heavily soiled:

- dilute some washing up liquid in water, in a ratio of one part detergent to six parts water.
- dip a soft, lint free in the solution and wring the it is damp.
- wipe the equipment with the damp cloth.
- dry the equipment by wiping it with a dry cloth.

FUSE REPLACEMENT

If a fuse blows, unplug the equipment from the mains supply.

Replace the fuse only with a fuse of the same type and rating.

Replacing the fuse with one of a higher rating or a slower action will not protect the equipment and will invalidate the warranty. If the replacement fuse blows again after the equipment is turned on, the equipment should be taken to an authorized service facility

REPAIRS

Only the most competent and qualified service technicians should be allowed to service the factory-trained warranty station personnel have the knowledge and special facilities needed for repair and calibration of this precision equipment. After the warranty period has expired, repairs will be performed for a charge if the equipment can be returned to normal operation.

In the event of difficulty, refer to your dealer or write directly to the nearest location to you that is listed on the Marantz Authorized Service Station list. If writing, please include the model and serial number of the equipment together with a full description of what you think is abnormal about the equipment's behavior.

TECHNICAL SPECIFICATIONS

FM TUNER SECTION

Frequency Range	87.5 - 108.0 MHz
Usable Sensitivity	IHF 1.8 μ V/16.4 dBf
Signal to Noise Ratio	Mono/Stereo 76/72 dB
Distortion	Mono/Stereo 0.2/0.3 %
Stereo Separation	1 kHz 45 dB
Alternate Channel Selectivity	\pm 300 kHz 60 dB
Image Rejection	98 MHz 70 dB
Tuner Output Level	1 kHz, \pm 40 kHz Dev 800 mV

AM TUNER SECTION

Frequency Range	LW: 152 - 282 kHz, MW: 531 - 1602 kHz
Signal to Noise Ratio	50 dB
Usable Sensitivity	Loop 400 μ V
Distortion	400 Hz, 30 % Mod. 0.5 %
Selectivity	\pm 18 kHz 40 dB

AUDIO SECTION

Continuous Power Output (40 Hz - 20 kHz)	8 ohms 50W / Ch (DIN)
THD (40 Hz - 20 kHz) at 40 W output	8 ohms 0.05 %
Input Sensitivity/Impedance	
Linear	220 mV/ 47 Kohms
Signal to Noise Ratio	
Linear (1 W)	77 dB

GENERAL

Power Requirement	AC 230 V 50 Hz
Power Consumption (STEREO MODE RATED POWER)	220 W
Dimension (MAX)	
Width	420 mm
Height	76 mm
Depth	322 mm
Weight	6.5 Kg

ACCESSORIES

Remote Control Unit RC2100SR	1
AAA-size batteries	2
FM Feeder Antenna	1
AM Loop Antenna	1

Specifications subject to change without prior notice.

COUNTRY	COMPANY	ADDRESS
ALGERIE	Azur 2000	8, Lotissement Ben Hatadi, Alger, Algeria
ARMENIA	NGYIG Ltd.	47 A/75 St. Lalaïants, 375000 Yerevan, Armenia
AUSTRALIA	Jamo Australia Pty. Ltd.,	24 Lionel Road, Mt. Waverley, VIC 3149, Australia
AUSTRIA	Huber & Prohaska GmbH	Taborstraße 95 / Ladestraße 1, Gebäude Hangartner, A-1200 Wien, Austria
BAHREIN	Ambassador Stores	P.O. Box 237,141, Government Avenue, Manama,Bahrein
BANGLADESH	Target	1078, Ramjoy Mohanja Lane Asadgonj, Chittagong 4000, Bangladesh
BELGIUM	Van der Heyden Audio N.V.	Brusselbaan 278, 9320 Erembodegem, Belgium
BULGARIA	Ariescommerce GmbH	Makedonia Blvd. 16, 1606 Sofia, Bulgaria
CANADA	Lenbrook Industries Limited	633 Granite Court, Pickering, Ontario
CHINA	Guang Chang Audio International Co., Ltd.	No.38 Yushan Road, ShiQiao, Pan Yu, Guang Dong, China
CYPRUS	Empire Hifi systems Ltd.	P.O. Box 5604, Nicosia, Cyprus
CZECH REPUBLIC	Audio International	Sokolska 41, 67902 Rajecko, OKR,Blansko, Czech Republic
DENMARK	Audio Nord	Dali Allé 1, 9610 Noerager, Denmark
DUBAI	V.V. & SONS	P.O. Box 105, Dubai, U.A.E.
EGYPT	Solimco	9, El Attibaa St. Doki, Cairo, Egypt
ESTONIA	HiFi Club Estonia	Ehte 4, 90503 Haapsalu, Estonia
F.Y.R.O.M.	T.P. KODI	ul.Cedomir Kantargiev 21a, Skopje, Former Yugoslavian Republic of Macedonia
FINLAND	Audio Nord	Uudenmaankatu 4-6, Helsinki SF-00120, Finland
FRANCE	Marantz France	A division of Marantz Europe B.V., P.O. Box 301, 92 156 Suresnes Cedex, France
GERMANY	Marantz Deutschland	Hakenbusch 3, 49078 Osnabrück, Germany
GREECE	Adamco S.A.	188, Hippocratous Street, 11471 Athens, Greece
HEADQUARTERS EUROPE:	Marantz Europe B.V.	Building SFF-2, P.O. Box 80002, 5600 JB Eindhoven, The Netherlands
HONG KONG	Marantz Asia Ltd.	Unit 1706, Metroplaza II, 223 Hing Fong Road, Kwai Fong, N.T., Kowloon, Hong Kong
HUNGARY	Infovox Ltd.	Terez Krt.31, 1067 Budapest, Hungary
ICELAND	ID Electronics Ltd.	Armula 38, 108 Reykjavik, Iceland
INDIA	NOVA Audio Private	8,Punam Co-op.Society 29/30 Road#5, Union Park MUMBAI 400052, India
IRAN	Home Co.	5th floor no 878 Philips Building Enghelab ave, P.O. 11365/7844 Tehran, Iran
IRELAND	Marantz Ireland	Clonskeagh, Dublin 14, Ireland
ISRAEL	Elmor Ltd.	52 Heh Beiyar Street, Kikar Hamedina, Tel Aviv, Israel
ITALY	Marantz Italy	Via Casati 23, 20052 Monza (Milano), Italy, Servizio Consumatori 1678-20026, Numero Verde
IVORY COAST	Hifivoir	B.P. 2428, Abidjan 01, Ivory Coast
JAPAN	Marantz Japan Inc.	35-1 Sagami Ohno 7-Chome, Sagamihara-shi, Kanagawa 228-8505, Japan
KOREA	Mk Enterprises Ltd.	121-210, 2F Shinhan Bldg., 247-17 Seokyo-dong, Mapo-ku, Seoul, Korea
KUWAIT	alAlamiah Electronics Intl.	P.O. Box 8196, Salmiah 22052, Kuwait
LATVIA	Ace Ltd.	61, LacPlesa Str., Riga LV 1011, Latvia
LEBANON	AZ Electronics S.A., 1,	P.O. Box 11 2833, Beirut, Lebanon
LITHUANIA	Accapella Ltd.	Ausros, Vartu G/5, Pasazo SKG., 2001 Vilnius, Lithuania
MALAYSIA	Wo Kee Hong Electronics Sdn. Bhd.	102 Jalan SS 21/35, Damansara Utama, 47400 Petaling Jaya, Selangordarul Ehsan, Malaysia
MALTA	Doneo Co Ltd.	78 The Strand, Sliema SLM07, Malta
MAURITIUS	SKR Electronics Ltd.	P.O. Box 685, Bell Village, Port Louis, Mauritius
MILITARY MARKET EUROPE	PASCO GmbH	PO BOX 1280, Sandhausen 69200, Germany
NETHERLANDS	Marantz Domestic Sales	A division of Marantz Europe B.V., Building SFF2, P.O. Box 80002, 5600 JB Eindhoven, The Netherlands
NEW ZEALAND	Wildash Audio Systems	14 Malvern Road, Mt. Albert, Auckland, New Zealand
NORWAY	Audio Nord	Sandkerveien 64, Oslo 0483, Norway
OMAN	Mustafa & Jawad Trading CO.	P.O. Box 1918, Ruwi, Oman
POLAND	Philips Polska Sp. z.o.o.	Al.Jerozolimskie 195b, 02 222 Warszawa, Poland
PORTUGAL	Corel2	Comércio de Electrónica Lda., Av. Luís Bivar, No 85 A, 1050 Lisboa, Portugal
PROFESSIONAL EUROPE	Marantz Professional Products	Kingsbridge House, Padbury Oaks, 575-583 Bath Road, Longford, Middlesex UB7 0EH, U.K.
PROFESSIONAL U.S.A.	Marantz Professional Products	Distributed by: Superscope Technologies Inc., 1000 Corporate Blvd. Ste.D, Aurora, Illino
QATAR	Almana & Partners W.W.L.	P.O. Box 49, Doha, Qatar
REUNION	Vision +	180 Rue du Marechal Leclerc, 97400 Saint Denis, Ile de la Reunion
ROMANIA	Nova Music Entertainment	5, Zagazului Str. Bl.1G,apt.18, sector 1,Bucharest, Romania
RUSSIA	Absolute Audio	7/2, Montazhnaya Street, 107497 Moscow, Russia
SAUDI ARABIA	Adawlia Univ. Electr. Apl	P.O. Box 2154, Alkhobar 31952, Saudi Arabia
SINGAPORE	Forward Marketing (S) Pte. Ltd.	Wo Kee Hong Centre, 29 Leng Kee Road, Singapore 159099, Singapore
SLOVAKIA	Bis Audio s.r.o.	Nam. SNP 10, 96001 Zvolem, Slovakia
SLOVENIA	Bofex	Smartinska 152, HALA V/3, 61000 Ljubljana, Slovenia
SOUTH AFRICA	Coherent Imports (PTY) Ltd.	P.O. Box 1614, Alberton, 1450, South Africa
SPAIN	Marantz Spain	Martinez Villergas 2, Apartado 2065, Madrid 28027, Spain
SRI LANKA	The listening Room	Mezzanine Floor, The Landmark 385, Galle Road, Colombo - 3, Sri Lanka
SWEDEN	Audio Nord	Almedalsvagen 4, Gotenborg 402-23, Sweden
SWITZERLAND	Sound Company AG	Postfach, 8010 Zürich, Switzerland
SYRIA	Hamzeh & Partners	Hafez Ibrahim Str. No 117, Damascus Shalan, Syria
TAHITI	Covecolor	Av. Prince Hinoi, Cours de l'union sacré, P.O. Box 2334, Papeete, Tahiti
TAIWAN	Pai-Yuing Co. Ltd.	6th No 148 Sung Kiang Road, Taipei 10429, Taiwan R.O.C.
THAILAND	MRZ Standard Co. Ltd.	746-750 Mahachai Road, Wangburapa, Bangkok 10200, Thailand
TUNESIA	Societe EDEVIG	40, Avenue du Golfe Arabe, El Menzah, 1004, Tunesia
TURKEY	Türk Philips Ticaret A.S.	Yukari Dudullu Organize sanayi Bolgesi, 2.Cadde no.28, 81260 Umraniye-Istanbul, Turkey
U.K.	Marantz Hifi UK Ltd.	Kingsbridge House, Padbury Oaks, 575-583 Bath Road, Longford, Middlesex UB7 0EH, U.K.
U.S.A.	Marantz America Inc.	440 Medinah Road, Roselle, IL 60172, U.S.A.
YUGOSLAVIA	ITM Company	Omladinskih Brigada 86, 11070 Belgrade, Yugoslavia
EXPORT	Marantz Domestic Sales	A division of Marantz Europe BV,Building SFF2, P.O. Box 80002, 5600 JB Eindhoven, TheThe Netherlands

www.marantz.com

Manufactured under license from Dolby Laboratories. "Dolby", "AC-3", "Pro Logic" and the double-D symbol are trademarks of Dolby Laboratories. Confidential Unpublished Works. © 1992-1997 Dolby Laboratories, Inc. All rights reserved.

marantz® is a registered trademark.

