

SVENSKA

NEDERLANDS

ESPAÑOL

ITALIANO

FRANÇAIS

DEUTSCH

ENGLISH



marantz[®] Super Audio CD player
SA-KI-PEARL-LITE

User Guide

SAFETY PRECAUTIONS



CAUTION
RISK OF ELECTRIC SHOCK
DO NOT OPEN



CAUTION:
TO REDUCE THE RISK OF ELECTRIC SHOCK, DO NOT REMOVE COVER (OR BACK). NO USER-SERVICEABLE PARTS INSIDE. REFER SERVICING TO QUALIFIED SERVICE PERSONNEL.



The lightning flash with arrowhead symbol, within an equilateral triangle, is intended to alert the user to the presence of uninsulated "dangerous voltage" within the product's enclosure that may be of sufficient magnitude to constitute a risk of electric shock to persons.



The exclamation point within an equilateral triangle is intended to alert the user to the presence of important operating and maintenance (servicing) instructions in the literature accompanying the appliance.

WARNING:
TO REDUCE THE RISK OF FIRE OR ELECTRIC SHOCK, DO NOT EXPOSE THIS APPLIANCE TO RAIN OR MOISTURE.

CLASS 1 LASER PRODUCT
LUOKAN 1 LASERLAITE
KLASS 1 LASERAPPARAT

CLASS 1 LASER PRODUCT
LUOKAN 1 LASERLAITE
KLASS 1 LASERAPPARAT

ADVARSEL: OSYNLIG LASERSTRÅLING VED ÅBNING, NÅR SIKKERHEDSAFBRYDERE ER UDE AF FUNKTION. UNDGÅ UDSAETTELSE FOR STRÅLING.

VAROITUS! LAITTEEN KÄYTTÄMINEN MUULLA KUIN TÄSSÄ KÄYTTÖOHJEESSA MAINITULLA TAVALLA SAATTAA ALTISTAA KÄYTTÄJÄN TURVALLISUUSLUOKAN 1 YLITTÄVÄLLE NÄKYMÄMTTÖMÄLLE LASERSÄTEILYLLE.

WARNING: OM APPARATEN ANVÄNDS PÅ ANNAT SÄTT ÄN I DENNA BRUKSANVISNING SPECIFICERATS, KAN ANVÄNDAREN UTSÄTTAS FÖR OSYNLIG LASERSTRÅLNING SOM ÖVERSKRIDER GRÄNSEN FÖR LASERKLASS 1.



ATTENZIONE: QUESTO APPARECCHIO E' DOTATO DI DISPOSITIVO OTTICO CON RAGGIO LASER. L'USO IMPROPRIO DELL'APPARECCHIO PUO' CAUSARE PERICOLOSE ESPOSIZIONI A RADIAZIONI!

IMPORTANT SAFETY INSTRUCTIONS

1. Read these instructions.
2. Keep these instructions.
3. Heed all warnings.
4. Follow all instructions.
5. Do not use this apparatus near water.
6. Clean only with dry cloth.
7. Do not block any ventilation openings. Install in accordance with the manufacturer's instructions.
8. Do not install near any heat sources such as radiators, heat registers, stoves, or other apparatus (including amplifiers) that produce heat.
9. Protect the power cord from being walked on or pinched particularly at plugs, convenience receptacles, and the point where they exit from the apparatus.
10. Only use attachments/accessories specified by the manufacturer.
11. Use only with the cart, stand, tripod, bracket, or table specified by the manufacturer, or sold with the apparatus. When a cart is used, use caution when moving the cart/apparatus combination to avoid injury from tip-over.
12. Unplug this apparatus during lightning storms or when unused for long periods of time.
13. Refer all servicing to qualified service personnel. Servicing is required when the apparatus has been damaged in any way, such as power-supply cord or plug is damaged, liquid has been spilled or objects have fallen into the apparatus, the apparatus has been exposed to rain or moisture, does not operate normally, or has been dropped.
14. Batteries shall not be exposed to excessive heat such as sunshine, fire or the like.



CAUTION:

To completely disconnect this product from the mains, disconnect the plug from the wall socket outlet. The mains plug is used to completely interrupt the power supply to the unit and must be within easy access by the user.

VORSICHT:

Um dieses Gerät vollständig von der Stromversorgung abzutrennen, ziehen Sie bitte den Stecker aus der Wandsteckdose. Der Netzstecker wird verwendet, um die Stromversorgung zum Gerät völlig zu unterbrechen; er muss für den Benutzer gut und einfach zu erreichen sein.

PRECAUTION:

Pour déconnecter complètement ce produit du courant secteur, débranchez la prise de la prise murale. La prise secteur est utilisée pour couper complètement l'alimentation de l'appareil et l'utilisateur doit pouvoir y accéder facilement.

ATTENZIONE:

Per scollegare completamente questo prodotto dalla rete di alimentazione elettrica, scollegare la spina dalla relativa presa a muro.

La spina di rete viene utilizzata per interrompere completamente l'alimentazione all'unità e deve essere facilmente accessibile all'utente.

PRECAUCIÓN:

Para desconectar completamente este producto de la alimentación eléctrica, desconecte el enchufe del enchufe de la pared. El enchufe de la alimentación eléctrica se utiliza para interrumpir por completo el suministro de alimentación eléctrica a la unidad y debe de encontrarse en un lugar al que el usuario tenga fácil acceso.

WAARSCHUWING:

Om de voeding van dit product volledig te onderbreken moet de stekker uit het stopcontact worden getrokken. De netstekker wordt gebruikt om de stroomtoevoer naar het toestel volledig te onderbreken en moet voor de gebruiker gemakkelijk bereikbaar zijn.

FÖRSIKTIGHETSMÅTT:

Koppla loss stickproppen från eluttaget för att helt skilja produkten från nätet. Stickproppen används för att helt bryta strömförsörjningen till apparaten, och den måste vara lättillgänglig för användaren.

CAUTION:

USE OF CONTROLS OR ADJUSTMENTS OR PERFORMANCE OF PROCEDURES OTHER THAN THOSE SPECIFIED HEREIN MAY RESULT IN HAZARDOUS RADIATION EXPOSURE. THIS PRODUCT SHOULD NOT BE ADJUSTED OR REPAIRED BY ANYONE EXCEPT PROPERLY QUALIFIED SERVICE PERSONNEL.

□ **NOTE ON USE / HINWEIS ZUM GEBRAUCH / OBSERVATIONS RELATIVES A L'UTILISATION / NOTE SULL'USO / NOTAS SOBRE EL USO / ALVORENSTE GEBRUIKEN / OBSERVERA ANGÅENDE ANVÄNDNINGEN**

WARNINGS	WARNHINWEISE	AVERTISSEMENTS	AVVERTENZE	ADVERTENCIAS	WAARSCHUWINGEN	VARNINGAR
<ul style="list-style-type: none"> • Avoid high temperatures. Allow for sufficient heat dispersion when installed in a rack. • Handle the power cord carefully. Hold the plug when unplugging the cord. • Keep the unit free from moisture, water, and dust. • Unplug the power cord when not using the unit for long periods of time. • Do not obstruct the ventilation holes. • Do not let foreign objects into the unit. • Do not let insecticides, benzene, and thinner come in contact with the unit. • Never disassemble or modify the unit in any way. • Ventilation should not be impeded by covering the ventilation openings with items, such as newspapers, tablecloths or curtains. • Naked flame sources such as lighted candles should not be placed on the unit. • Observe and follow local regulations regarding battery disposal. • Do not expose the unit to dripping or splashing fluids. • Do not place objects filled with liquids, such as vases, on the unit. • Do not handle the mains cord with wet hands. • When the switch is in the OFF position, the equipment is not completely switched off from MAINS. • The equipment shall be installed near the power supply so that the power supply is easily accessible. 	<ul style="list-style-type: none"> • Vermeiden Sie hohe Temperaturen. Beachten Sie, dass eine ausreichende Belüftung gewährleistet wird, wenn das Gerät auf ein Regal gestellt wird. • Gehen Sie vorsichtig mit dem Netzkabel um. Halten Sie das Kabel am Stecker, wenn Sie den Stecker herausziehen. • Halten Sie das Gerät von Feuchtigkeit, Wasser und Staub fern. • Wenn das Gerät längere Zeit nicht verwendet werden soll, trennen Sie das Netzkabel vom Netzstecker. • Decken Sie den Lüftungsbereich nicht ab. • Lassen Sie keine fremden Gegenstände in das Gerät kommen. • Lassen Sie das Gerät nicht mit Insektiziden, Benzin oder Verdünnungsmitteln in Berührung kommen. • Versuchen Sie niemals das Gerät auseinander zu nehmen oder zu verändern. • Die Belüftung sollte auf keinen Fall durch das Abdecken der Belüftungsöffnungen durch Gegenstände wie beispielsweise Zeitungen, Tischtücher, Vorhänge o. Ä. behindert werden. • Auf dem Gerät sollten keinerlei direkte Feuerquellen wie beispielsweise angezündete Kerzen aufgestellt werden. • Bitte beachten Sie bei der Entsorgung der Batterien die örtlich geltenden Umweltbestimmungen. • Das Gerät sollte keiner tropfenden oder spritzenden Flüssigkeit ausgesetzt werden. • Auf dem Gerät sollten keine mit Flüssigkeit gefüllten Behälter wie beispielsweise Vasen aufgestellt werden. • Das Netzkabel nicht mit feuchten oder nassen Händen anfassen. • Wenn der Schalter ausgeschaltet ist (OFF-Position), ist das Gerät nicht vollständig vom Stromnetz (MAINS) abgetrennt. • Das Gerät sollte in der Nähe einer Netzsteckdose aufgestellt werden, damit es leicht an das Stromnetz angeschlossen werden kann. 	<ul style="list-style-type: none"> • Eviter des températures élevées. Tenir compte d'une dispersion de chaleur suffisante lors de l'installation sur une étagère. • Manipuler le cordon d'alimentation avec précaution. Tenir la prise lors du débranchement du cordon. • Protéger l'appareil contre l'humidité, l'eau et la poussière. • Débrancher le cordon d'alimentation lorsque l'appareil n'est pas utilisé pendant de longues périodes. • Ne pas obstruer les trous d'aération. • Ne pas laisser des objets étrangers dans l'appareil. • Ne pas mettre en contact des insecticides, du benzène et un diluant avec l'appareil. • Ne jamais démonter ou modifier l'appareil d'une manière ou d'une autre. • Ne pas recouvrir les orifices de ventilation avec des objets tels que des journaux, nappes ou rideaux. Cela entraverait la ventilation. • Ne jamais placer de flamme nue sur l'appareil, notamment des bougies allumées. • Veillez à respecter les lois en vigueur lorsque vous jetez les piles usagées. • L'appareil ne doit pas être exposé à l'eau ou à l'humidité. • Ne pas poser d'objet contenant du liquide, par exemple un vase, sur l'appareil. • Ne pas manipuler le cordon d'alimentation avec les mains mouillées. • Lorsque l'interrupteur est sur la position OFF, l'appareil n'est pas complètement déconnecté du SECTEUR (MAINS). • L'appareil sera installé près de la source d'alimentation, de sorte que cette dernière soit facilement accessible. 	<ul style="list-style-type: none"> • Evitate di esporre l'unità a temperature elevate. Assicuratevi che vi sia un'adeguata dispersione del calore quando installate l'unità in un mobile per componenti audio. • Maneggiate il cavo di alimentazione con attenzione. Tenete ferma la spina quando scollegate il cavo dalla presa. • Tenete l'unità lontana dall'umidità, dall'acqua e dalla polvere. • Scollegate il cavo di alimentazione quando prevedete di non utilizzare l'unità per un lungo periodo di tempo. • Non coprite i fori di ventilazione. • Non inserite corpi estranei all'interno dell'unità. • Assicuratevi che l'unità non entri in contatto con insetticidi, benzolo o solventi. • Non smontate né modificate l'unità in alcun modo. • Le aperture di ventilazione non devono essere ostruite coprendole con oggetti, quali giornali, tovaglie, tende e così via. • Non posizionate sull'unità fi amme libere, come ad esempio candele accese. • Prestate attenzione agli aspetti legati alla tutela dell'ambiente nello smaltimento delle batterie. • L'apparecchiatura non deve essere esposta a gocciolii o spruzzi. • Non posizionate sull'unità alcun oggetto contenente liquidi, come ad esempio i vasi. • Non toccare il cavo di alimentazione con le mani bagnate. • Quando l'interruttore è nella posizione OFF, l'apparecchiatura non è completamente scollegata da MAINS. • L'apparecchio va installato in prossimità della fonte di alimentazione, in modo che quest'ultima sia facilmente accessibile. 	<ul style="list-style-type: none"> • Evite altas temperaturas. Permita la suficiente dispersión del calor cuando está instalado en la consola. • Maneje el cordón de energía con cuidado. Sostenga el enchufe cuando desconecte el cordón de energía. • Mantenga el equipo libre de humedad, agua y polvo. • Desconecte el cordón de energía cuando no utilice el equipo por mucho tiempo. • No obstruya los orificios de ventilación. • No deje objetos extraños dentro del equipo. • No permita el contacto de insecticidas, gasolina y diluyentes con el equipo. • Nunca desarme o modifique el equipo de ninguna manera. • La ventilación no debe quedar obstruida por haberse cubierto las aperturas con objetos como periódicos, manteles o cortinas. • No deberán colocarse sobre el aparato fuentes inflamables sin protección, como velas encendidas. • A la hora de deshacerse de las pilas, respete la normativa para el cuidado del medio ambiente. • No exponer el aparato al goteo o salpicaduras cuando se utilice. • No colocar sobre el aparato objetos llenos de líquido, como jarras. • No maneje el cable de alimentación con las manos mojadas. • Cuando el interruptor está en la posición OFF, el equipo no está completamente desconectado de la alimentación MAINS. • El equipo se instalará cerca de la fuente de alimentación de manera que resulte fácil acceder a ella. 	<ul style="list-style-type: none"> • Vermijd hoge temperaturen. Zorg er bij installatie in een audiorack voor, dat de door het toestel geproduceerde warmte goed kan worden afgevoerd. • Hanteer het netsnoer voorzichtig. Houd het snoer bij de stekker vast wanneer deze moet worden aan- of losgekoppeld. • Laat geen vochtigheid, water of stof in het apparaat binnendringen. • Neem altijd het netsnoer uit het stopcontact wanneer het apparaat gedurende een lange periode niet wordt gebruikt. • De ventilatieopeningen mogen niet worden geblokkeerd. • Laat geen vreemde voorwerpen in dit apparaat vallen. • Voorkom dat insecticiden, benzene of verfvendunners met dit toestel in contact komen. • Dit toestel mag niet gedemonteerd of aangepast worden. • De ventilatie mag niet worden belemmerd door de ventilatieopeningen af te dekken met bijvoorbeeld kranten, een tafelkleed of gordijnen. • Plaats geen open vlammen, bijvoorbeeld een brandende kaars, op het apparaat. • Houd u steeds aan de milieuvoorschriften wanneer u gebruikte batterijen wegdoet. • Stel het apparaat niet bloot aan druppels of spatten. • Plaats geen voorwerpen gevuld met water, bijvoorbeeld een vaas, op het apparaat. • Raak het netsnoer niet met natte handen aan. • Als de schakelaar op OFF staat, is het apparaat niet volledig losgekoppeld van de netspanning (MAINS). • De apparatuur wordt in de buurt van het stopcontact geïnstalleerd, zodat dit altijd gemakkelijk toegankelijk is. 	<ul style="list-style-type: none"> • Undvik höga temperaturer. Se till att det finns möjlighet till god värmeavledning vid montering i ett rack. • Hantera nätkabeln varsamt. Håll i kabeln när den kopplas från el-uttaget. • Utsätt inte apparaten för fukt, vatten och damm. • Koppla loss nätkabeln om apparaten inte kommer att användas i lång tid. • Täpp inte till ventilationsöppningarna. • Se till att främmande föremål inte tränger in i apparaten. • Se till att inte insektsmedel på spraybruk, bensen och thinner kommer i kontakt med apparatens hölje. • Ta inte isär apparaten och försök inte bygga om den. • Ventilationen bör inte förhindras genom att täcka för ventilationsöppningarna med föremål såsom tidningar, bordsdukar eller gardiner. • Placera inte öppen eld, t.ex. tända ljus, på apparaten. • Tänk på miljöaspekterna när du bortskaffar batterier. • Apparaten får inte utsättas för vätska. • Placera inte föremål fyllda med vätska, t.ex. vaser, på apparaten. • Hantera inte nätsladden med våta händer. • Även om strömbrytaren står i det avstängda läget OFF, så är utrustningen inte helt bortkopplad från det elektriska nätet (MAINS). • Utrustningen ska vara installerad nära strömuttaget så att strömförsörjningen är lätt att tillgå.

• DECLARATION OF CONFORMITY

We declare under our sole responsibility that this product, to which this declaration relates, is in conformity with the following standards: EN60065, EN55013, EN55020, EN61000-3-2 and EN61000-3-3. Following the provisions of Low Voltage Directive 2006/95/EC and EMC Directive 2004/108/EC, the EC regulation 1275/2008 and its frame work Directive 2009/125/EC for Energy-related Products (ErP).

• ÜBEREINSTIMMUNGSERKLÄRUNG

Wir erklären unter unserer Verantwortung, daß dieses Produkt, auf das sich diese Erklärung bezieht, den folgenden Standards entspricht: EN60065, EN55013, EN55020, EN61000-3-2 und EN61000-3-3. Gemäß den Bestimmungen der Niederspannungsrichtlinie 2006/95/EG und EMV Richtlinie 2004/108/EG, der Verordnung (EG) Nr. 1275/2008 der Kommission und deren Rahmenrichtlinie 2009/125/EG zu energieverbrauchsrelevanten Produkten (ErP).

• DECLARATION OF CONFORMITE

Nous déclarons sous notre seule responsabilité que l'appareil, auquel se réfère cette déclaration, est conforme aux standards suivants: EN60065, EN55013, EN55020, EN61000-3-2 et EN61000-3-3. Selon la directive 2006/95/EC concernant la basse tension et la directive CEM 2004/108/EC, la réglementation européenne 1275/2008 et la directive 2009/125/EC établissant un cadre de travail applicable aux produits liés à l'énergie (ErP).

• DICHIARAZIONE DI CONFORMITÀ

Dichiariamo con piena responsabilità che questo prodotto, al quale la nostra dichiarazione si riferisce, è conforme alle seguenti normative: EN60065, EN55013, EN55020, EN61000-3-2 e EN61000-3-3. Facendo seguito alle disposizioni della direttiva sul basso voltaggio 2006/95/EC alla direttiva EMC 2004/108/EC, alla norma EC 1275/2008 e alla relativa legge quadro 2009/125/EC in materia di prodotti alimentati ad energia (ErP). QUESTO PRODOTTO E' CONFORME AL D.M. 28/08/95 N. 548

• DECLARACIÓN DE CONFORMIDAD

Declaramos bajo nuestra exclusiva responsabilidad que este producto al que hace referencia esta declaración, está conforme con los siguientes estándares: EN60065, EN55013, EN55020, EN61000-3-2 y EN61000-3-3. De acuerdo con la directiva sobre baja tensión 2006/95/CE y la directiva sobre CEM 2004/108/CE, la normativa CE 1275/2008 y su directiva marco 2009/125/EC para productos relacionados con la energía (ErP).

• EENVORMIGHEIDSVKLAARING

Wij verklaren uitsluitend op onze verantwoordelijkheid dat dit produkt, waarop deze verklaring betrekking heeft, in overeenstemming is met de volgende normen: EN60065, EN55013, EN55020, EN61000-3-2 en EN61000-3-3. Volgens de voorzieningen van lage spanningsrichtlijn 2006/95/EC en EMC-richtlijn 2004/108/CE, de EU-richtlijn 1275/2008 en de kaderrichtlijn 2009/125/EC voor energieverbruikende producten (ErP).

• ÖVERENSSTÄMMELSESINTYG

Härmed intygas helt på eget ansvar att denna produkt, vilken detta intyg avser, uppfyller följande standarder: EN60065, EN55013, EN55020, EN61000-3-2 och EN61000-3-3. Uppfyller reglerna i lågspänningsdirektivet 2006/95/EC och EMC-direktivet 2004/108/EC, EU-förordningen 1275/2008 och ramverksdirektivet 2009/125/EC för energirelaterade produkter (ErP).

Marantz Europe
A division of D&M Europe B.V.
Beemdstraat 11, 5653 MA Eindhoven,
The Netherlands

A NOTE ABOUT RECYCLING:

This product's packaging materials are recyclable and can be reused. Please dispose of any materials in accordance with the local recycling regulations. When discarding the unit, comply with local rules or regulations. Batteries should never be thrown away or incinerated but disposed of in accordance with the local regulations concerning battery disposal. This product and the supplied accessories, excluding the batteries, constitute the applicable product according to the WEEE directive.

HINWEIS ZUM RECYCLING:

Das Verpackungsmaterial dieses Produktes ist zum Recyceln geeignet und kann wieder verwendet werden. Bitte entsorgen Sie alle Materialien entsprechend der örtlichen Recycling-Vorschriften. Beachten Sie bei der Entsorgung des Gerätes die örtlichen Vorschriften und Bestimmungen. Die Batterien dürfen nicht in den Hausmüll geworfen oder verbrannt werden; bitte entsorgen Sie die Batterien gemäß der örtlichen Vorschriften. Dieses Produkt und das im Lieferumfang enthaltene Zubehör (mit Ausnahme der Batterien!) entsprechen der WEEE-Direktive.

UNE REMARQUE CONCERNANT LE RECYCLAGE:

Les matériaux d'emballage de ce produit sont recyclables et peuvent être réutilisés. Veuillez disposer des matériaux conformément aux lois sur le recyclage en vigueur. Lorsque vous mettez cet appareil au rebut, respectez les lois ou réglementations en vigueur. Les piles ne doivent jamais être jetées ou incinérées, mais mises au rebut conformément aux lois en vigueur sur la mise au rebut des piles. Ce produit et les accessoires inclus, à l'exception des piles, sont des produits conformes à la directive DEEE.

NOTA RELATIVA AL RICICLAGGIO:

I materiali di imballaggio di questo prodotto sono riutilizzabili e riciclabili. Smaltire i materiali conformemente alle normative locali sul riciclaggio. Per lo smaltimento dell'unità, osservare le normative o le leggi locali in vigore. Non gettare le batterie, né incenerirle, ma smaltirle conformemente alla normativa locale sui rifiuti chimici. Questo prodotto e gli accessori inclusi nell'imballaggio sono applicabili alla direttiva RAEE, ad eccezione delle batterie.

ACERCA DEL RECICLAJE:

Los materiales de embalaje de este producto son reciclables y se pueden volver a utilizar. Disponga de estos materiales siguiendo los reglamentos de reciclaje de su localidad. Cuando se deshaga de la unidad, cumpla con las reglas o reglamentos locales. Las pilas nunca deberán tirarse ni incinerarse. Deberá disponer de ellas siguiendo los reglamentos de su localidad relacionados con los desperdicios químicos. Este producto junto con los accesorios empaquetados es el producto aplicable a la directiva RAEE excepto pilas.

EEN AANTEKENING MET BETREKKING TOT DE RECYCLING:

Het inpakmateriaal van dit product is recycleerbaar en kan opnieuw gebruikt worden. Er wordt verzocht om zich van elk afvalmateriaal te ontdoen volgens de plaatselijke voorschriften. Volg voor het wegdoen van de speler de voorschriften voor de verwijdering van wit- en bruingoed op. Batterijen mogen nooit worden weggegooid of verbrand, maar moeten volgens de plaatselijke voorschriften betreffende chemisch afval worden verwijderd. Op dit product en de meegeleverde accessoires, m.u.v. de batterijen is de richtlijn voor afgedankte elektrische en elektronische apparaten (WEEE) van toepassing.

OBSERVERA ANGÅENDE ÅTERVINNING:

Produktens emballage är återvinningsbart och kan återanvändas. Kassera det enligt lokala återvinningsbestämmelser. När du kasserar enheten ska du göra det i överensstämmelse med lokala regler och bestämmelser. Batterier får absolut inte kastas i soporna eller brännas. Kassera dem enligt lokala bestämmelser för kemiskt avfall. Denna apparat och de tillbehör som levereras med den uppfyller gällande WEEE-direktiv, med undantag av batterierna.



Pb

CAUTIONS ON INSTALLATION
VORSICHTSHINWEISE ZUR AUFSTELLUNG
PRÉCAUTIONS D'INSTALLATION
PRECAUZIONI SULL'INSTALLAZIONE
EMPLAZAMIENTO DE LA INSTALACIÓN
VOORZORGSMAATREGELEN BIJ DE INSTALLATIE
FÖRSIKTIGHET VID INSTALLATIONEN

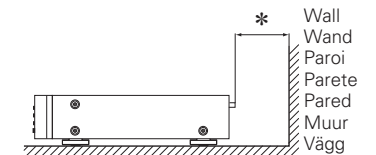
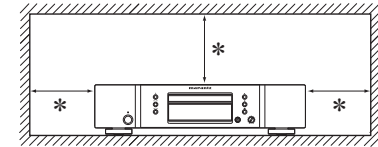

* For proper heat dispersal, do not install this unit in a confined space, such as a bookcase or similar enclosure.

- More than 0.1 m is recommended.
- Do not place any other equipment on this unit.

* Stellen Sie das Gerät nicht an einem geschlossenen Ort, wie in einem Bücherregal oder einer ähnlichen Einrichtung auf, da dies eine ausreichende Belüftung des Geräts behindern könnte.

- Empfohlen wird über 0,1 m.
- Keine anderen Gegenstände auf das Gerät stellen.

* Pour permettre la dissipation de chaleur requise, n'installez pas cette unité dans un espace confiné tel qu'une bibliothèque ou un endroit similaire.

- Une distance de plus de 0,1 m est recommandée.
- Ne placez aucun matériel sur cet appareil.

* Per una dispersione adeguata del calore, non installare questa apparecchiatura in uno spazio ristretto, come ad esempio una libreria o simili.

- Si raccomanda una distanza superiore ai 0,1 m.
- Non posizionare alcun altro oggetto o dispositivo su questo dispositivo.

* Para la dispersión del calor adecuadamente, no instale este equipo en un lugar confinado tal como una librería o unidad similar.

- Se recomienda dejar más de 0,1 m alrededor.
- No coloque ningún otro equipo sobre la unidad.

* Plaats dit toestel niet in een kleine afgesloten ruimte, zoals een boekenkast e.d., omdat anders de warmte niet op gepaste wijze kan worden afgevoerd.

- Meer dan 0,1 m is aanbevolen.
- Plaats geen andere apparatuur op het toestel.

* För att tillförsäkra god värmeavledning får utrustningen inte installeras i instängda utrymmen, som t.ex. en bokhylla eller liknande.

- Mer än 0,1 m rekommenderas.
- Placera ingen annan utrustning ovanpå den här enheten.

CD-плеер Marantz SA-KI-PEARL-LITE (РУКОВОДСТВО ПО ЭКСПЛУАТАЦИИ)



Вы приобрели устройство воспроизводящее производства компании "D&M Холдингс Инк", Япония ("D & M Holdings Inc.", Japan). Модель SA-KI-PEARL-LITE является CD-плеер и предназначена для проигрывания CD-дисков в домашних аудиосистемах. Это изделие широко известно в кругах истинных ценителей высококлассного звука. Качество и безопасность подтверждены множеством тестов, проведенных как зарубежными, так и российскими испытательными лабораториями.

Изготовитель в течение 3 лет (срок службы) после выпуска данного изделия обеспечивает наличие комплектующих в целях возможности проведения ремонта и технического обслуживания, по истечении которого эксплуатация и техническое обслуживание продолжается в соответствии с действующими нормативными документами. Изделие остается безопасным для жизни, здоровья человека и окружающей среды в течение всего срока эксплуатации. Гарантийный срок - 1 год.

Информация о Российской сертификации

Но сертификата соответствия	Орган по сертификации	Нормативные документы	Наименование сертифицированной продукции	Срок действия сертификата
РОСС JPAЯ46.B13706	РОСТЕСТ-МОСКВА	ГОСТ Р МЭК 60065-2005 ГОСТ 22505-97 ГОСТ Р 51515-99 ГОСТ Р 51317.3.2.-2006 ГОСТ Р 51317.3.3-2008	Проигрыватели CD-дисков	До 11.04.2013

Основные технические характеристики

См. в конце инструкции

ВНИМАНИЕ: Если Вы приобрели аудиоаппаратуру надлежащего качества, то, по Российским законам, она не подлежит возврату или обмену на аналогичный товар других размера, формы и т.д.

D&M Холдингс Инк
Здание D&M, 2-1 Ниссин-тё
Кавасаки-ку, Кавасаки-си, Канагава
2108569, Япония

D&M Holdings Inc.
D&M Building, 2-1 Nisshin-Cho
Kawasaki-Ku, Kawasaki-Shi, Kanagawa
2108569, Japan

Accessories

Check that the following parts are supplied with the product.

- | | |
|---|---|
| ① User guide | 1 |
| ② AC power cord (Cord length: Approx. 1.8 m) | 1 |
| ③ Audio connecting cable (Cord length: Approx. 1.0 m) | 1 |
| ④ Remote control connecting cable..... | 1 |
| ⑤ Remote controller (RC004SA) | 1 |
| ⑥ AAA-size batteries | 2 |

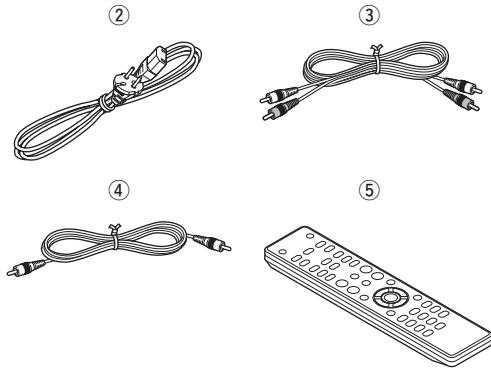

About this manual

❑ Operation buttons

The operations described in this manual are based mainly on remote control operation.

❑ Symbols



This symbol indicates a reference page on which related information is described.



This symbol indicates a supplementary information and tips for operations.

NOTE

This symbol indicates points to remember operations or function limitations.

❑ Illustrations

Note that the illustrations in these instructions are for explanation purposes and may differ from the actual unit.

Main features

Toroidal transformer

This unit features a toroidal transformer that produces less vibration and magnetic leakage flux compared to conventional power transformers. The materials and manufacturing process of the ring-shaped core are strictly controlled to reduce vibration, while the short-ring attached to the perimeter of the transformer reduce magnetic leakage flux.

Large-capacitance block capacitor

A large capacitance 3300 μF capacitor carefully selected for its acoustic characteristics is incorporated into the power supply circuit.

Audiophile-grade film capacitors and electrolytic capacitors

The unit's features the same audiophile-grade film capacitors and electrolytic capacitors specifically used in top-range models.

Low-noise low-distortion filter circuit and high-speed HDAMSA2-type output amplifier with the differential input type HDAM

Double-layered and Copper-plated chassis

High-grade machined analog audio output connectors

Playback of CD-R/CD-RW discs

Playback of CD-R/CD-RW/CD-ROM discs (MP3/WMA) and USB audio (MP3/WMA/WAV/AAC)/iPod

Can be used as a D/A convertor

Digital audio signals input from an external device or computer into this unit can be converted and output as analog signals using this unit's D/A converter.

Cautions on handling

• Before turning the power switch on

Check once again that all connections are correct and that there are no problems with the connection cables.

- When leaving home for long periods of time, be sure to unplug the power cord from the power outlet.

• Proper ventilation

If the unit is left in a room full of the smoke from cigarettes, etc., for long periods of time, the surface of the optical pickup may get dirty, preventing it from receiving the signals properly.

• About condensation

If there is a major difference in temperature between the inside of the unit and its surroundings, condensation may form on parts inside the unit, causing the unit to fail to operate properly.

If this happens, let the unit sit for an hour or two with the power off and wait until there is little difference in temperature before using the unit.

• Cautions on using mobile phones

Using a mobile phone near this unit may result in noise. If that occurs, move the mobile phone away from the unit when it is in use.

• Moving the unit

Turn off the power and unplug the power cord from the power outlet. Next, disconnect the cables connected to other system units before moving the unit.

Discs

Discs playable on this unit

① Super Audio CDs

Super Audio CDs with the following logos indicated below can be played on this unit.



② Music CDs

Discs marked with the logo at right can be played in this unit.

③ CD-R/CD-RW

NOTE

- Discs in special shapes (heart-shaped discs, octagonal discs, etc.) cannot be played. Do not attempt to play them, as doing so can damage the unit.
- Some discs and some recording formats cannot be played.
- Non-finalized discs cannot be played.



※ What is finalization?

Finalization is the process that makes recorded CD-R/CD-RW discs playable on compatible players.

Holding discs



Do not touch the signal surface.

Loading discs

- Place the disc in the tray, label side up.
- Make sure the disc tray is fully open when inserting the disc.
- Place the discs flat, 12 cm discs in the outer tray guide (Figure 1), 8 cm discs in the inner tray guide (Figure 2).

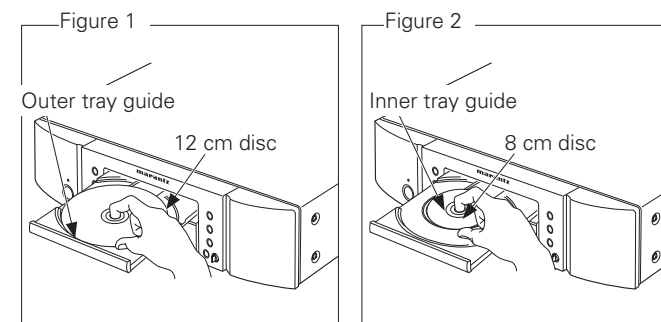

- Place 8 cm discs in the inner tray guide without using an adapter.

NOTE

- If you place a DVD or other disc that cannot be played by this unit in the disc tray, the tray does not open/close for about 1 minute. When that happens, press **▲** after "Error" is displayed.
- If you place a disc that contains other than MP3 or WMA files, "No File" is displayed.

Cautions on loading discs

- Only load one disc at a time. Loading two or more discs can damage the unit or scratch the discs.
- Do not use cracked or warped discs or discs that have been repaired with adhesive, etc.
- Do not use discs on which the sticky part of cellophane tape or labels is exposed or on which there are traces of where labels have been removed. Such discs can get caught inside the player and damage it.

Cautions on handling

- Do not get fingerprints, oil or dirt on discs.
- Take special care not to scratch discs when removing them from their cases.
- Do not bend or heat discs.
- Do not enlarge the hole in the center.
- Do not write on the labeled (printed) surface with ball-point pens, pencils, etc., or stick new labels on discs.
- Water droplets may form on discs if they are moved suddenly from a cold place (outdoors for example) to a warm place, but do not try to dry them off using a hairdryer, etc.

Cautions on storing discs

- Be sure to remove discs after using them.
- Be sure to store discs in their cases to protect them from dust, scratches, warping, etc.
- Do not store discs in the following places:
 1. Places exposed to direct sunlight for long periods of time
 2. Dusty or humid places
 3. Places exposed to heat from heaters, etc.

Cleaning discs

- If there are fingerprints or dirt on a disc, wipe them off before using the disc. Fingerprints and dirt can impair sound quality and cause interruptions in playback.
- Use a commercially available disc cleaning set or a soft cloth to clean discs.

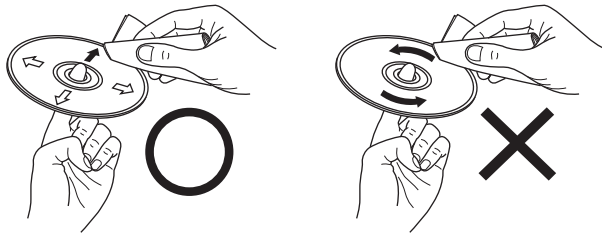

Gently wipe the disc from the inside towards the outside.

Do not wipe in a circular motion.

NOTE

Do not use record spray, antistatic agents, benzene, thinner or other solvents.

About the remote control

Inserting the batteries

- ① Remove the rear cover of the remote control.
- ② Set two R03/AAA batteries in the battery compartment in the indicated direction.

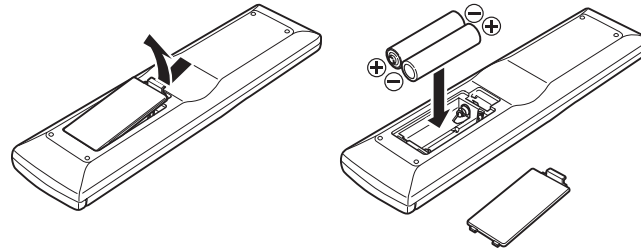

- ③ Put the rear cover back on.

NOTE

- Replace the batteries with new ones if the unit does not operate even when the remote control is operated close to the unit.
- The supplied batteries are only for verifying operation.
- Insert the batteries in the proper direction, following the “+” and “-” marks in the battery compartment.
- To prevent damage or leakage of battery fluid:
 - Do not use a new battery with an old one.
 - Do not use two different types of batteries.
 - Do not attempt to charge dry batteries.
 - Do not short-circuit, disassemble, heat or dispose of batteries in a fire.
 - Do not keep the battery in a place exposed to direct sunlight or in places with extremely high temperatures, such as near a heater.
- If the battery fluid leaks, carefully wipe the fluid off the inside of the battery compartment and insert new batteries.
- Remove the batteries from the remote control if it will not be used for a long time.
- Dispose of batteries in accordance with local regulations on battery disposal.

Operating range of the remote control

Operate the remote control while pointing it at the remote sensor.

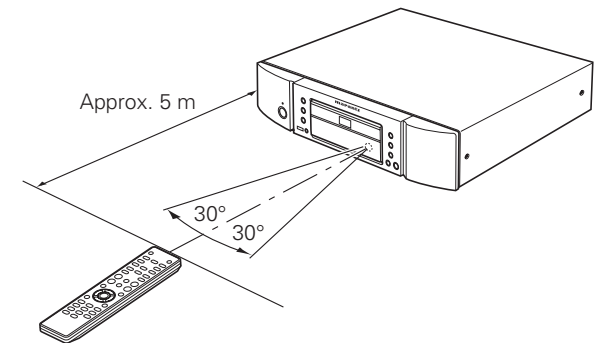

NOTE

The unit may function improperly or the remote control may not operate if the remote control sensor is exposed to direct sunlight or strong artificial light from a fluorescent or infrared light.

Part names and functions

For buttons not explained here, see the page indicated in parentheses ().

Front panel

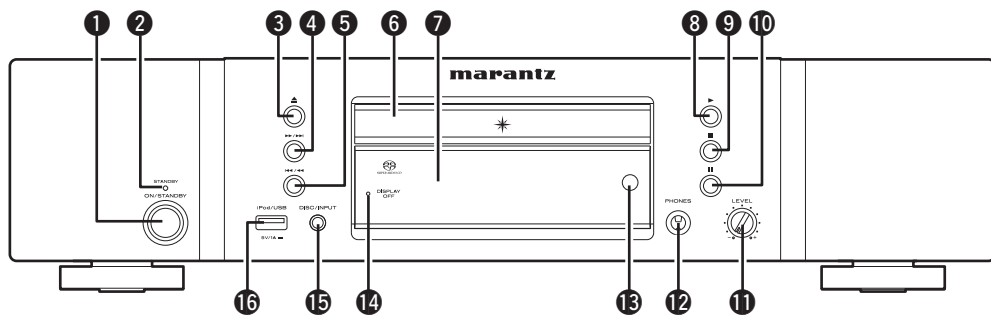

- 1 Power operation switch (ON/STANDBY)** (8)
- 2 Power indicator (STANDBY)** (8)
The light indicates the CD player operating status as follows:
• Power "ON" Turn off
• Standby Red
- 3 Disc tray open/close button (▲)** (9)
- 4 Fast forwarding/Forward-skip button (▶▶, ▶▶I)** (9)
- 5 Fast reversing/Reverse-skip button (I◀◀, ◀◀)** (9)
- 6 Disc tray** (9)
- 7 Display** (5)
- 8 Play button (▶)** (8)
- 9 Stop button (■)** (8)
- 10 Pause button (II)** (8)
- 11 Headphone volume control knob (LEVEL)** (10)
- 12 Headphones jack (PHONES)** (10)
- 13 Remote control sensor** (4)
- 14 DISPLAY OFF indicator** (10)
- 15 DISC/INPUT button** (9)
- 16 USB port (iPod/USB)** (13)

Display

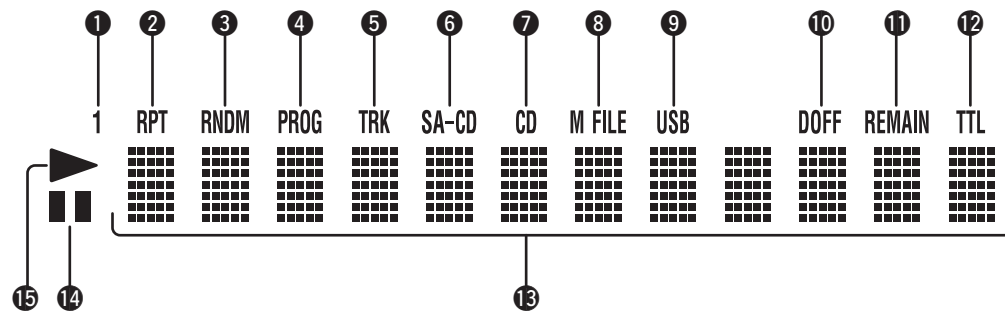

- 1 1 (repeat) indicator**
This indicator lights up during repeat play of one track.
- 2 RPT (repeat) indicator**
This indicator lights up during repeat play.
- 3 RNDM (random) indicator**
This indicator lights up during random play.
- 4 PROG (program) indicator**
This indicator lights up during program play.
- 5 TRK (track) indicator**
This indicator lights up above the display of the track number currently being played.
- 6 SA-CD indicator**
This indicator indicates the type of disc on the disc tray (Super Audio CD).
- 7 CD indicator**
This indicator indicates the type of disc on the disc tray (CD).
- 8 M FILE indicator**
This indicator indicates the type of disc on the disc tray (WMA/MP3).
- 9 USB indicator**
This indicator lights up during operation in the USB/iPod mode.
- 10 D OFF (digital output OFF) indicator**
This indicator lights up when the digital output setting of the audio CD signal is set to OFF (page 11).
- 11 REMAIN (remaining time) indicator**
This indicator lights up above the remaining playback time of a track, when it is displayed.
- 12 TTL (total time) indicator**
This indicator lights up above the total remaining time or the total program time, when it is displayed.
- 13 Main display area**
This area displays the time display and text information of the disc to be played, as well as the setting menu items, etc.
- 14 II (pause) indicator**
This indicator lights up when play is paused.
- 15 ▶ (play) indicator**
This indicator lights up during disc play.

Rear panel

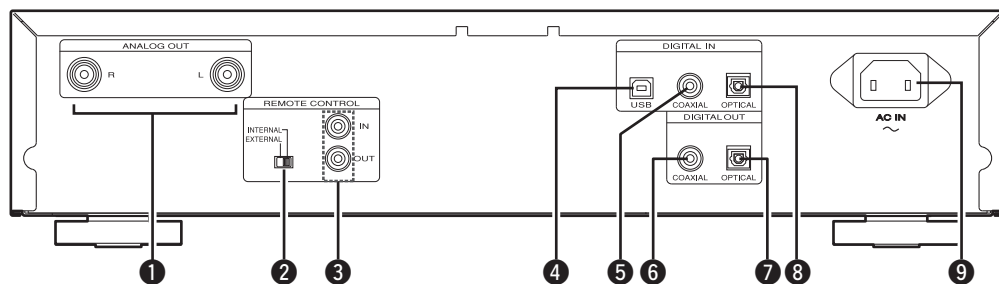

- 1 ANALOG OUT connectors (7)
- 2 EXTERNAL/INTERNAL switch (13)
- 3 REMOTE CONTROL IN / OUT connectors (13)
- 4 DIGITAL IN USB port (PC) (13)
- 5 DIGITAL IN COAXIAL connector (12)
- 6 DIGITAL OUT COAXIAL connector (12)
- 7 DIGITAL OUT OPTICAL connector (12)
- 8 DIGITAL IN OPTICAL connector (12)
- 9 AC inlet (AC IN) (7)

Remote control

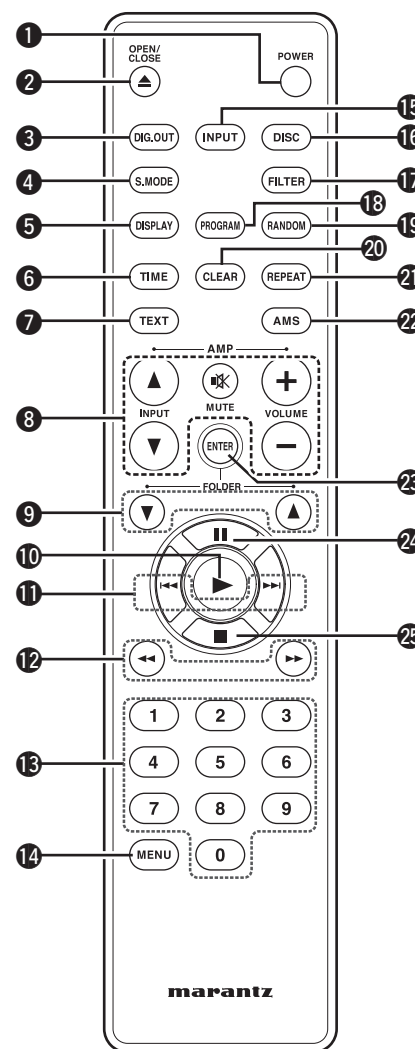

- 1 POWER button (8)
- 2 OPEN/CLOSE button (▲) (9)
- 3 DIG. OUT button (11)
- 4 S. MODE button (8)
- 5 DISPLAY button (10)
- 6 TIME button (10)
- 7 TEXT button (20,22)
- 8 Amplifier operation buttons
VOLUME button (+, -)
INPUT button (▲, ▼)
MUTE button
- 9 FOLDER buttons (17)
(FOLDER ▲, ▼)
- 10 Play button (▶) (9,16,17)
- 11 Track skip buttons (◀◀, ▶▶) (9)
- 12 Search buttons (◀◀, ▶▶) (9)
- 13 Number buttons (0 - 9) (9)
- 14 MENU button (19)
- 15 INPUT button (8)
- 16 DISC button (8)
- 17 FILTER button (Not use)
- 18 PROGRAM button (11)
- 19 RANDOM button (10)
- 20 CLEAR button (11)
- 21 REPEAT button (10)
- 22 Auto music scan button (AMS) (11)
- 23 ENTER button (19)
- 24 Pause button (||) (8)
- 25 Stop button (■) (8)



- The supplied remote control can operate Marantz amplifiers.
- When using it, also refer to the operating instructions of the other devices.

NOTE

The remote control may not operate some devices.

Basic connections

This chapter explains how to connect the analog device (amp) and power cord.

For other connections, see the sections below.

- ❑ **Digital connection** (👉 page 12)
- ❑ **USB memory device/iPod connection** (👉 page 13)
- ❑ **PC connection** (👉 page 13)
- ❑ **Remote control connection** (👉 page 14)

NOTE

- Do not plug in the power cord until all connections have been completed.
- When making connections, also refer to the owner's manual of the other components.
- Insert the plugs securely. Loose connections will result in the generation of noise.
- Be sure to connect the left and right channels properly (left with left, right with right).
- Do not bundle power cords together with connection cables. Doing so can result in humming or noise.
- Do not connect the unit to the PHONO input connectors on the amplifier.

Preparations

Connecting cables

Select the cables according to the equipment being connected.

Audio cables

Analog connections (stereo)



Audio cable (supplied)

Analog connection

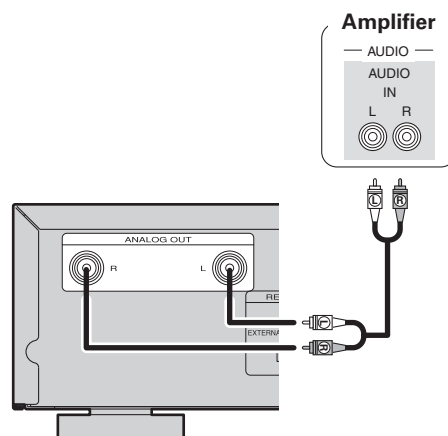

Connecting the power cord

Do not plug in the power cord until all connections have been completed.

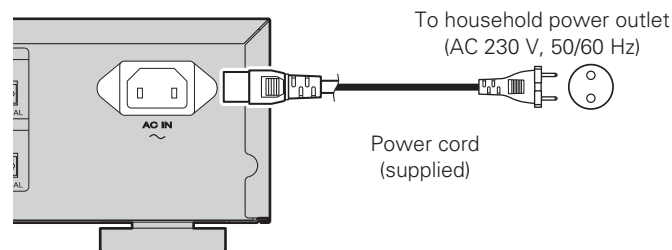

NOTE

- Insert the plugs securely. Loose connections will result in the generation of noise.
- Do not unplug the power cord while the unit is operating.
- Do not use a power cord other than the cord supplied with this unit.

Basic operation

Symbols used to indicate buttons in this manual

- Button located on both the main unit and the remote control → **BUTTON**
- Button only on the main unit → **<BUTTON>**
- Button only on the remote control → **[BUTTON]**

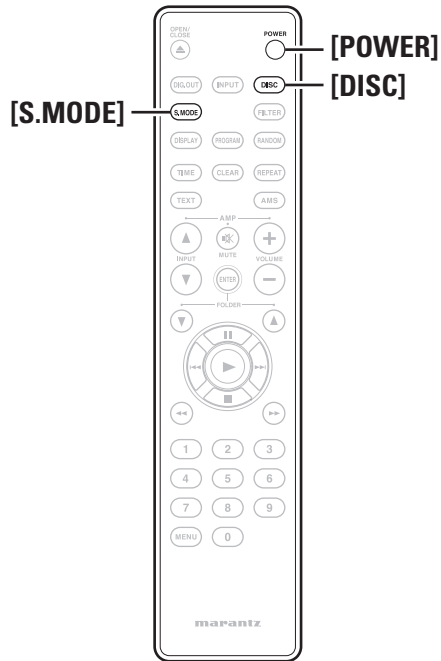
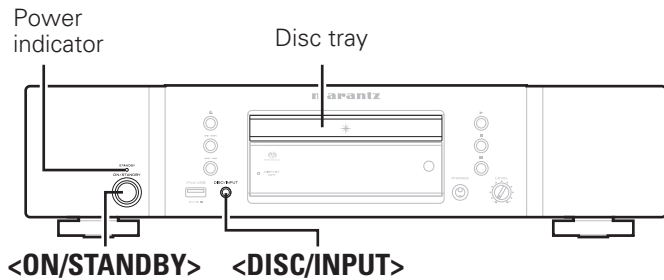

This chapter explains the procedures required to playback a CD, and the various operations that can be performed during CD playback.

For other operations, see the sections below.

- ❑ Playback of MP3 and WMA files (page 14)
- ❑ Playback iPod® (page 16)
- ❑ Playing a USB memory device (page 17)
- ❑ Using as a D/A converter (page 18)
- ❑ Performing menu settings (page 19)

Before use

Switching the sound mode (Playback layer)

Some super audio CD discs have 2 layers. Before playback, perform the operation below to select the playback layer. For details on the super audio CD, see "Super audio CD" (page 23).

The sound mode can also be set using "SA-CD (Switching sound mode)" (page 20) in the setting menu.

- 1 Turn the power on.**
(Press <ON/STANDBY>.)
- 2 Check that no disc is loaded.**
 - If the layer is switched while a disc is in the player or the disc tray is opened, the playback layer switches for that disc, but the top priority playback layer setting itself does not change.
- 3 Press <DISC / INPUT> or [DISC] to set the playback media mode to "DISC".**
- 4 Press [S.MODE] and switch to the layer you want to set (Super Audio CD only).**



[Selectable items]

- SA-CD** : Plays back the 2-channel area of the Super Audio CD (the default setting).
- CD** : Plays back the CD layer of the Super Audio CD.

Before use

- When a disc is loaded after the setting has been made, the contents recorded on the unit layer are displayed.
- If a disc that does not contain the layer set for top priority playback is loaded, the contents recorded on another layer are displayed automatically.
- This setting is stored in the memory and is not cleared even when the disc holder is opened or closed or the power is turned off. To change the setting, repeat the procedure above.

If a layer in which nothing is recorded is selected, the other layer that exists on the disc is played back automatically.

NOTE
Sound mode cannot be changed for discs with only a Super Audio CD area.

Turning the power off

Press <ON/STANDBY> or [POWER].
Power is set to standby and the power indicator lights.

Before setting power to standby, make sure the disc tray is completely closed.

NOTE

- Do not force the tray in by hand while power is set to standby. This could cause a trouble.
- Even when power is set to standby, electrical current passes through some circuits. If you do not intend to use the unit for an extended period of time, unplug the power cord from the household power outlet.

Symbols used to indicate buttons in this manual

- Button located on both the main unit and the remote control → **BUTTON**
- Button only on the main unit → **<BUTTON>**
- Button only on the remote control → **[BUTTON]**

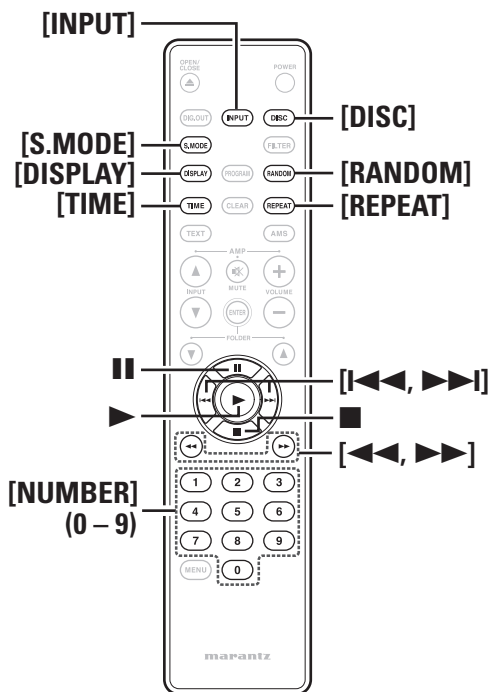
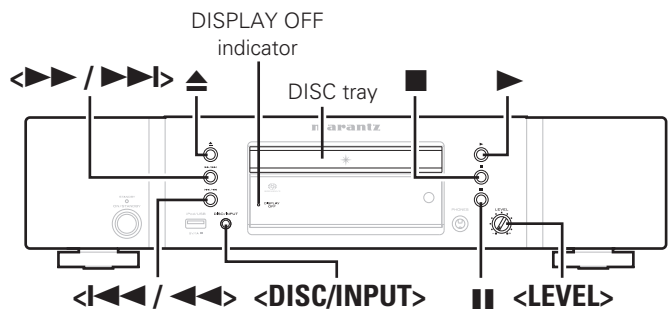

Switching the input source

This unit supports the following playback functions in addition to disc playback.

- Digital audio input signal playback
 - USB memory device file playback from the USB port in the front panel
 - iPod file playback from the USB port in the front panel
 - Computer file playback from the USB port in the rear panel
- Before playing back files from a connected device, perform the following operation to switch the input source.

Press **<DISC/INPUT>** or **[INPUT]** to select the input source.

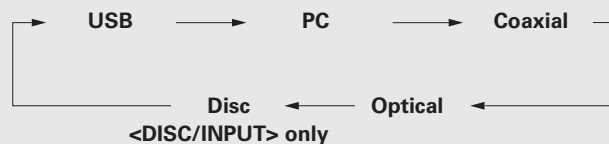

[Selectable items]

- USB** : Plays back files on the device connected to the USB port (iPod/USB) on the front panel. (☞ page 16,17)
- PC** : Connect a computer to the USB port (DIGITAL IN) on the rear panel, and use this unit as a D/A converter. (☞ page 19)
- Coaxial** : Connect a digital device to the COAXIAL port (DIGITAL IN) on the rear panel, and use this unit as a D/A converter. (☞ page 19)
- Optical** : Connect a digital device to the OPTICAL port (DIGITAL IN) on the rear panel, and use this unit as a D/A converter. (☞ page 19)
- Disc** : Plays back the disc inside the disc tray. (☞ page 9)



You can press **[DISC]** to switch the input source to "Disc".

Playback CDs

Playing Super Audio CDs or CDs

- 1 Press **<DISC/INPUT>** or **[DISC]** to change the input source to "Disc".
- 2 Insert a disc.
 - Press **▲** to open and close the disc tray.
 - When you press **▶** and close the Disc tray, "Toc Reading" is displayed in the Display and then playback will start.
- 3 When playing back a super audio CD, press **[S.MODE]**, and select the layer that you want to play back.

```

        graph LR
          SA-CD --> CD
      
```
- 4 Press **▶**.
 - The "▶" display lights, and playback begins.
 - When all of the tracks recorded on the disc have finished playing back, playback stops automatically.

Stopping Playback

Press **■**.

Stopping Playback temporarily

Press **||**.

- The "||" indicator lights.
- To restart playback, press **▶** or **||**.

Fast-Forwarding and Fast-Reversing (Searching)

[Using the buttons on the main unit]

The search is started by holding down **<|<<</<<<>**, **<>>>/>>>>** during playback.

The search speed can be changed by holding down **<|<<</<<<>**, **<>>>/>>>>**.

The search speed changes in 4 steps: 1 → 2 → 3 → 4 → 1. 4 is the fastest search speed.

[Using the buttons on the remote control]

The search is started by pressing **[<<<<]**, **[>>>>]** during playback.

The search speed can be changed by pressing **[<<<<]**, **[>>>>]**.

The search speed changes in 4 steps: 1 → 2 → 3 → 4 → 1. 4 is the fastest search speed.

Moving to the Beginning of Tracks (Skipping)

[Using the buttons on the main unit]

During playback, press <|◀◀/◀◀> or <▶▶/▶▶>.

- The disc is skipped the number of tracks equal to the number of times the button is pressed.
- When you press <|◀◀/◀◀> once, playback restarts from the beginning of the current track.

[Using the buttons on the remote control]

During playback, press [◀◀] or [▶▶].

- The disc is skipped the number of tracks equal to the number of times the button is pressed.
- When you press [◀◀] once, playback restarts from the beginning of the current track.

Playing a Specific Track (Direct searching)

Press [NUMBER] (0 – 9) to select the track.

[Example] : Track 4 : Press number [4] to select Track No. 4.

[Example] : Track 12 : Press numbers [1] and [2] consecutively to select Track No. 12.



The number you enter is set about 1.5 seconds after you press the number buttons. To enter a two-digit number, be sure to press the two number buttons, one immediately after the other.

Turning off display

During playback, press [DISPLAY].

- Each time [DISPLAY] is pressed, the display brightness changes as shown below.

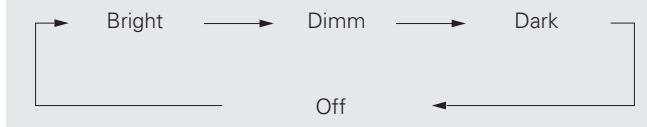

When the display is switched off, the "DISPLAY OFF" indicator lights.

NOTE

During stop mode, the display information does not turn off. The information is turned off only during playback.

To change time display

Press [TIME].

- When [TIME] is pressed each time, the display shows differently in the following orders.

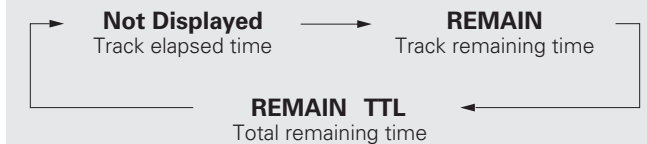

Listening with headphone

Plug the headphones into the headphone jack (PHONES).

Adjusting the Volume

Turn <LEVEL>.

NOTE

To prevent hearing loss, do not raise the volume level excessively when using headphones.

Playing repeatedly (Repeat Playback)

Press [REPEAT] to select repeat mode.

When [REPEAT] is pressed each time, the display switches repeat modes in the following order.



[Selectable items]

RPT (All-track repeat) : All tracks are played repeatedly.

1 RPT (1-track repeat) : Only 1 track is played repeatedly.

Not Displayed (Repeat off) : Normal playback resumes.



When repeat playback is set, random playback and AMS playback cannot be performed.

Playing in random order (Random playback)

During stop mode, press [RANDOM].

The "RNDM" indicator on the display lights and random playback starts.

Stopping Random Playback

Press [RANDOM] during stop mode.

The "RNDM" indicator on the display goes off.

NOTE

Repeat Play and AMS Play cannot be conducted when the unit is in Random Mode.

- If <▶▶/▶▶>, or [▶▶] are pressed during Random Play, the player jumps to the next track of the shuffled order.
- To search through the current track during random play, press and continue holding <|◀◀/◀◀>, <▶▶/▶▶> or press [<<, ▶▶].

The random playback mode is canceled if you set power to standby, turn off power, or open the disc tray.

Symbols used to indicate buttons in this manual

- Button located on both the main unit and the remote control → **BUTTON**
- Button only on the main unit → **<BUTTON>**
- Button only on the remote control → **[BUTTON]**

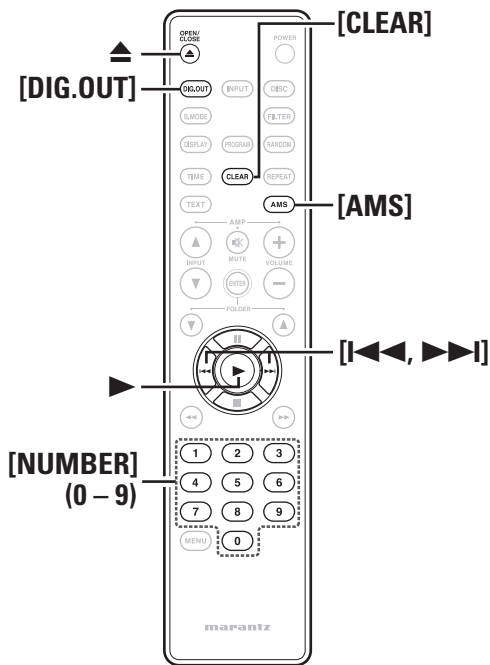
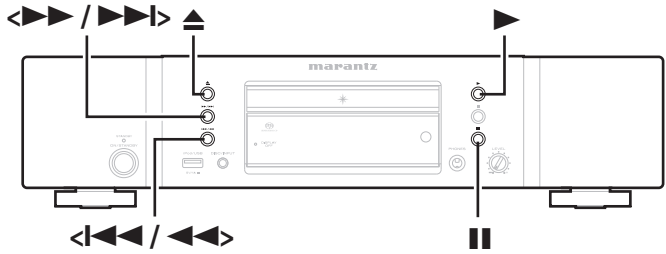

Playing tracks in a specific order (Program playback)

- 1 During stop mode, press [PROGRAM].**
 - "PROG" lights in the display, and the mode switches to program playback mode.
- 2 Use [NUMBER] (0 – 9), [I<<<, >>>I] or <I<<</>>>, >>>/>>>I to select the tracks you want to program.**

[Example]
To program tracks 3 and 12 to be played in that order, press [3], [1], and [2] one after the other.

 - The number you enter is set about 1.5 seconds after you press the number buttons.
- 3 Press ▶.**
Playback starts in the programmed order.



To enter a two-digit number, be sure to press the two number buttons, one immediately after the other.

Adding tracks for program playback

Tracks can be added to the end of program when program is remaining ("PROG" indicator is lighting up) and in stop mode.

- Canceling a track from program playback
While stopped, press **[CLEAR]**.
When **[CLEAR]** is pressed, tracks are deleted in order from the last programmed track.

Clearing the all programmed track

During program playback, press ■ twice.
During stop mode, press ■ once.
Program can also be cleared by pressing ▲ to open the disc tray.



You can specify up to 24 tracks each for program playback.

NOTE

- Repeat Play, Random Play, and AMS Play cannot be conducted while the unit is in PROGRAM mode (i.e. when the PROG indicator is lit).
- Programmed playback is not possible with MP3 and WMA files.
- The program playback mode is canceled if you set power to standby, turn off power, or open the disc tray.

Searching for a specific track (AMS play)

You can play back all track intros, from the first track onward, in sequence. This function is useful when you search for a specific track you want to listen to. (AMS playback: Auto Music Scan playback)

- 1 During playback or stop mode, press [AMS].**
 - "▶" flashes in the display, and 10-second AMS playback starts.
 - When 10 second AMS playback is selected, playback automatically switches to the next track.
- 2 When you find the track you want to listen to, press ▶.**
The Play indicator "▶" lights and normal playback is resumed.

NOTE

AMS playback cannot be performed during program playback and random playback.

Setting the digital output

Set to output from the rear panel DIGITAL OUT terminal (COAXIAL, OPTICAL).

During stop mode, press [DIG. OUT].

Each time **[DIG.OUT]** is pressed, output from the DIGITAL OUT terminal (COAXIAL, OPTICAL) on the rear panel is switched between "On" and "Off".

[Selectable items]

- On** : Outputs the digital signal.
- Off** : Digital signal is not output.



- When digital output is turned off, the "D OFF" indicator lights up on the display.
- When digital output is turned off, you can enjoy high quality audio output from the ANALOG OUT terminal.
- The "digital output off" has a memory retention function where the settings remain stored and unchanged even when the disc is changed or the power is turned off.

NOTE

Data on Super Audio CDs or WMA/MP3 data on discs cannot be output from the DIGITAL OUT terminal.

Advanced connections

This chapter describes how to connect a digital device, USB memory device/iPod, computer, and remote control. For other connections, see the sections below.

- ❑ Analog connection (👉 page 7)
- ❑ Connecting the power cord (👉 page 7)

Preparations

Connecting cables

Select the cables according to the equipment being connected.

Audio cables	
Optical digital connections	
	Optical cable (sold separately)
Coaxial digital connections	
	Coaxial digital cable (sold separately)
iPod connections	
	iPod cable (sold separately)
PC connections	
	USB cable (sold separately)
Remote control connection	
	Remote connector cord (supplied)

Digital connection

When connecting, use a commercially available optical digital cable or coaxial digital cable.

Digital audio output

You can enjoy digital recording when the player is connected to a CD recorder or other digital recording component.

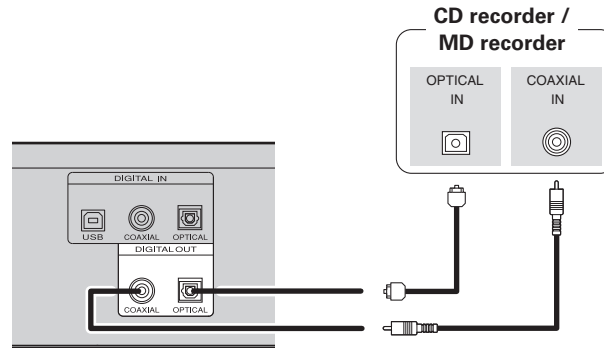

NOTE

Signals on the HD layer of the super audio CD and MP3 or WMA signals recorded onto the disc cannot be output in digital output. Signals that can be output using digital output are digital audio signals from audio CDs, CD-layers of super audio CDs, USB, iPod, PC, COAXIAL, and OPTICAL.

When connecting the optical digital output connector with an optical transmission cable (sold separately)

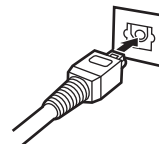

Match the shapes then insert firmly.

Digital audio input

If a device equipped with CD transport or digital audio output is connected to this unit, this unit can be used as a D/A converter. ("Using as a D/A converter" (👉 page 18))

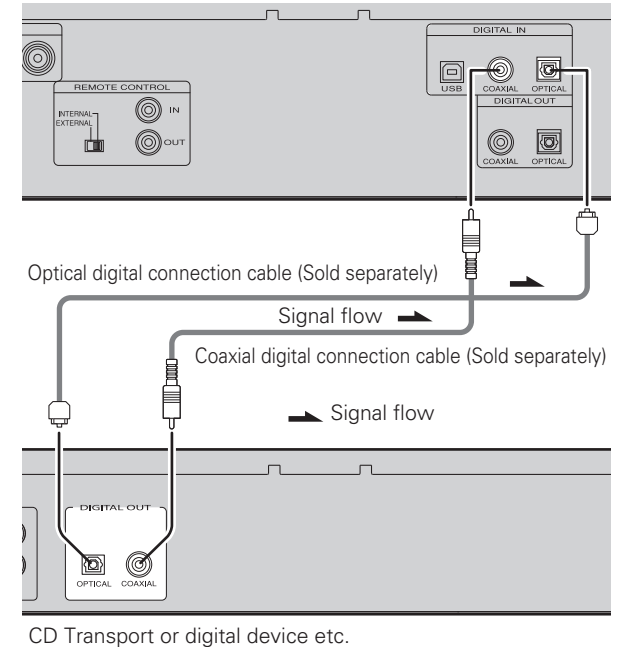

NOTE

- Linear PCM signals with a sampling frequency of 32kHz, 44.1kHz, 48kHz, 64kHz, 88.2kHz, 96kHz, 176.4kHz, or 192kHz can be input into this device.
- Do not input signals other than linear PCM signals, such as Dolby digital, DTS, AAC etc. into this device. Doing so may cause noise, which may cause damage to the speakers.

USB memory device/iPod connection

Connect a USB memory device/iPod to the USB port on the front panel of this unit.

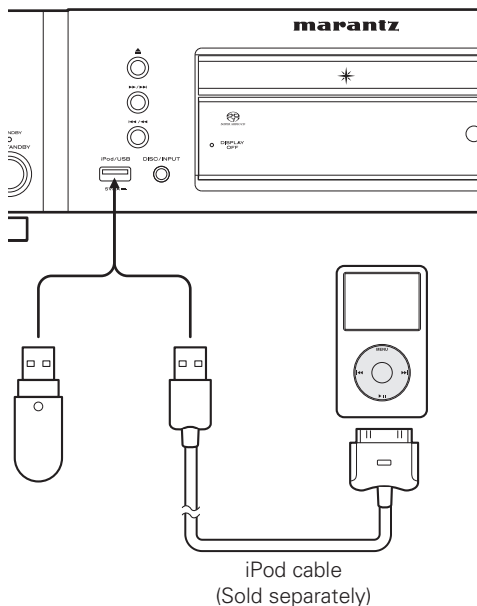

NOTE

When using an USB memory device, do not use an USB extension cable.
When connecting an iPhone to this unit, keep the iPhone at least 20 cm away from this unit. If the iPhone is kept closer to this unit and a telephone call is received by the iPhone, noise may be output from this device.

Supported iPod Models

Made for

- iPod touch (3rd generation)
- iPod touch (2nd generation)
- iPod touch (1st generation)
- iPod classic
- iPod with video
- iPod nano (5th generation)
- iPod nano (4th generation)
- iPod nano (3rd generation)
- iPod nano (2nd generation)
- iPod nano (1st generation)
- iPhone
- iPhone 3G
- iPhone 3GS

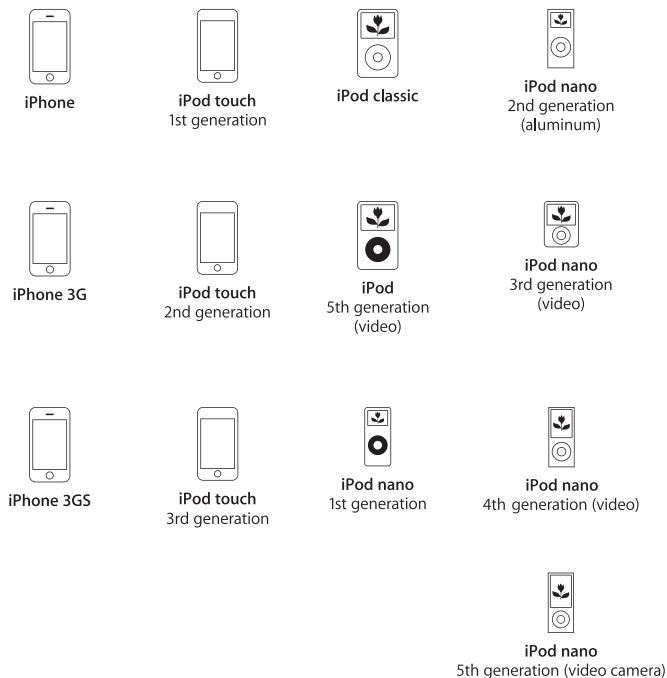

PC connection

By connecting a computer to the USB port on the rear panel of this unit using a commercially available USB connecting cable, this unit can be used as a D/A converter. ("Using as a D/A converter" (page 18))

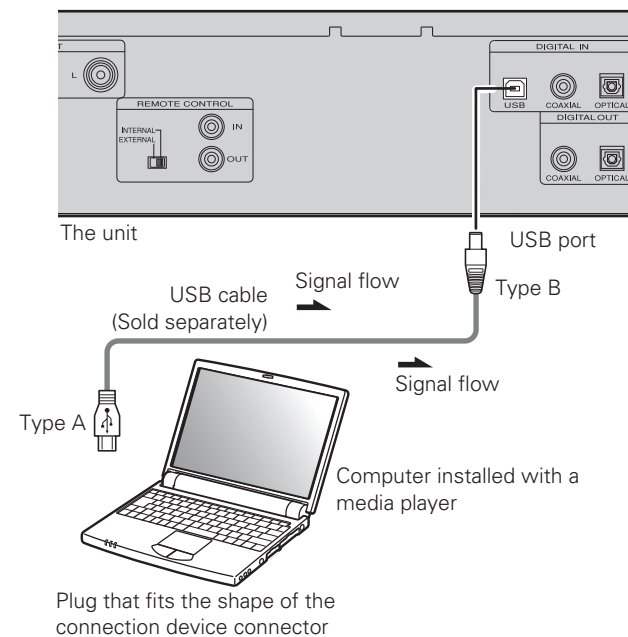

Remote control connection

When you use this unit connected to a Marantz amplifier, this unit receives operation signals sent from the amplifier and operates accordingly.

❑ Connection

Use the supplied remote connection cable to connect the REMOTE CONTROL IN terminal of this unit to REMOTE CONTROL OUT terminal of the amplifier.

❑ Setting

Set the remote control switch on the rear panel of this unit to "EXTERNAL" to use this feature.

- This setting will disable remote sensor reception of this unit.
- To operate the unit, point the remote control at the remote sensor of the amplifier.



To use this unit without connecting it to the amplifier, set the remote control switch to "INTERNAL".

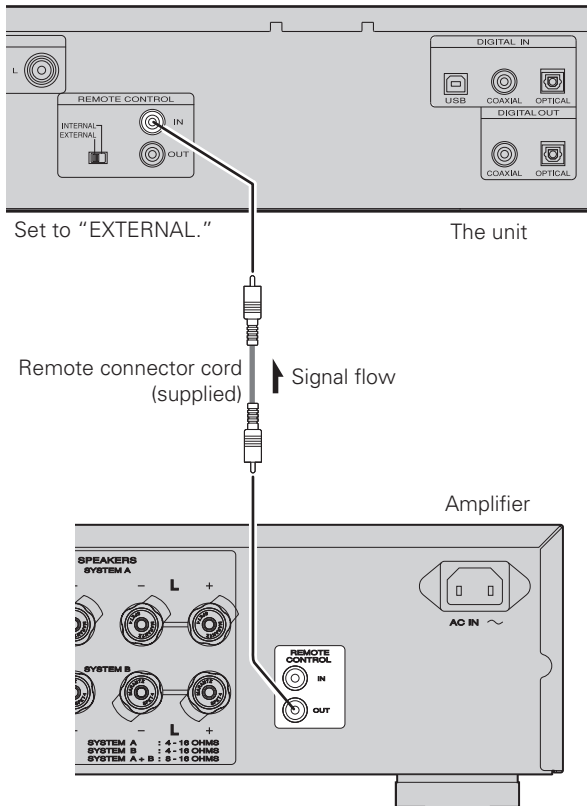

Advanced operations



Symbols used to indicate buttons in this manual

- Button located on both the main unit and the remote control → **BUTTON**
- Button only on the main unit → **<BUTTON>**
- Button only on the remote control → **[BUTTON]**

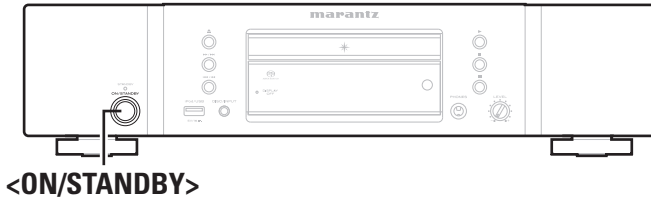

Before playback using a USB memory device or iPod

- 1 Press **<ON/STANDBY>**.
- 2 Connect the USB memory device or iPod cable to the USB terminal.

NOTE

- When a USB memory device is connected to this unit, the files recorded onto the USB memory device are read. The time needed to read the files depends on the size of the files on the USB memory device. If the maximum number of files and folders are recorded onto the device, it may take a few minutes to read all of the files.
- To turn off the power to this unit, stop playback on the USB memory device or iPod before turning the power off.

Playback of MP3 and WMA files

There are many music distribution sites on the Internet allowing you to download music files in MP3 or WMA (Windows Media® Audio) formats. The music (files) downloaded from such sites can be stored on CD-R or CD-RW discs and played on the unit.

"Windows Media" and "Windows" are registered trademarks or trademarks of Microsoft Corporation in the United States and other countries.

MP3 and WMA formats

CD-R and CD-RW discs created in the format described below can be played.

❑ Writing software format

- ISO9660 level 1, 2
- Expansion format (Juliet.Romeo)

- When written in other formats, it may not be possible to play the disc properly.

❑ Maximum number of playable files and folders

- Total number of folders and files : 648
- Number of folders : 299

❑ File formats

- MP3 (MPEG-1 Audio Layer-3)
- WMA (Windows Media Audio)

❑ Tag data

- ID3-Tags (Ver. 1.x and 2.x)
- META-Tags
- (Compatible with title, artist and album names)

Playable MP3/WMA file			
File format	Sampling frequency	Bit rate	Extension
MP3	44.1 kHz	For MPEG-1 Audio Layer-3, 32/40/48/56/64/80/96/112/128/160/192/224/256/320 kbps	.mp3
WMA	44.1 kHz	48/64/80/96/128/160/192 kbps	.wma

Symbols used to indicate buttons in this manual

- Button located on both the main unit and the remote control → **BUTTON**
- Button only on the main unit → **<BUTTON>**
- Button only on the remote control → **[BUTTON]**

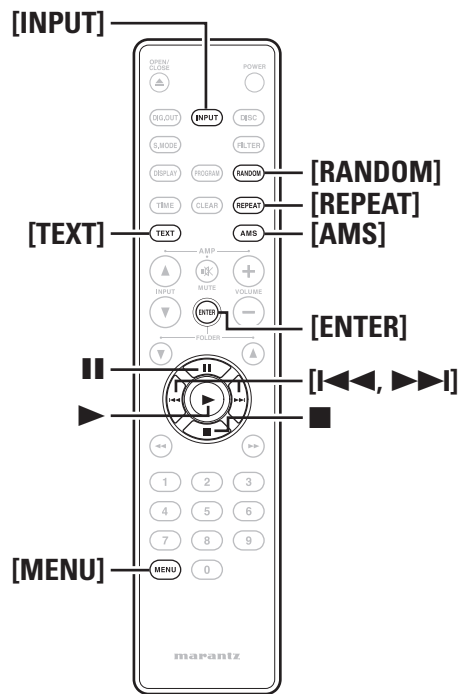
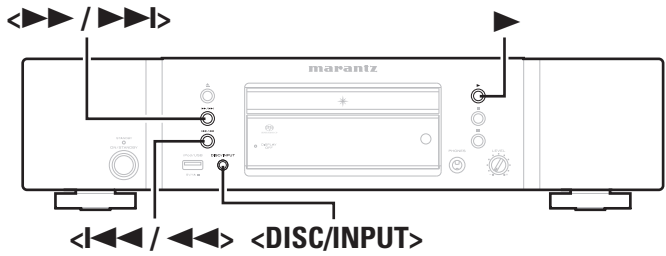

MP3 or WMA playback order of MP3 or WMA files

When there are multiple folders containing MP3 or WMA files, the playback order of folders is automatically set when this unit reads the media. The files in each folder are played back in the order in which the files were recorded on the media, from the oldest date and time.

□ Playback order of folders

CD-R/CD-RW

For playback of files on CD-R or CD-RW, files in all folders on the first layer are played first, next on the second layer, then next on the third layer, and so on in this order.

USB memory device

For playback of files recorded on USB memory device, files in the first folder on the first layer are played first, next folders on the second layer in the folder, then next on the third layer, and so on in this order. Then accordingly files on another first layer are played.



- The playback order displayed on a PC may differ from the actual playback order.
- The playback order with a CD-R/CD-RW may differ, depending on the writing software.

NOTE

The playback order may differ from the order in which the folders or files were recorded if you delete or add a folder or file on USB memory device. This occurs because of data recording specifications and is not a malfunction.



- Only music files that are not copyright-protected can be played on this unit.
- Be sure to give files the extension “.MP3” or “.WMA”. Files with any other extensions or with no extensions cannot be played.
- In accordance with copyright laws, recordings you have made should only be used for your personal enjoyment and may not be used in other ways without permission of the copyright holder.

Playing MP3 and WMA files

- 1 Load a CD-R or CD-RW disc containing music files in the MP3 or WMA formats into the disc tray.
- 2 Press **▶**. Playback starts.

Changing the file to be played

Use **<◀◀/▶▶▶▶** or **[◀◀, ▶▶▶▶]** to select the desired file.

Switching the Display

During playback, press **[TEXT]**. The file name is displayed only by 8 characters for few second. The file names do not automatically scroll on the display.

Playback iPod®

With the unit, you can listen to music on an iPod and you can also operate the iPod with the main unit or the remote control.



“Made for iPod” and “Made for iPhone” mean that an electronic accessory has been designed to connect specifically to iPod or iPhone, respectively, and has been certified by the developer to meet Apple performance standards. Apple is not responsible for the operation of this device or its compliance with safety and regulatory standards.

iPhone, iPod, iPod classic, iPod nano, iPod shuffle, and iPod touch are trademarks of Apple Inc., registered in the U.S. and other countries.

- Individual users are permitted to use iPhone, iPod, iPod classic, iPod nano, iPod shuffle, and iPod touch for private copy and playback of non-copyrighted contents and contents whose copy and playback is permitted by law. Copyright infringement is prohibited by law.

Playing an iPod®

1 Press **<DISC/INPUT>** or **[INPUT]** to change the input source to “USB”.

2 Connect the iPod to the USB terminal on the front panel of this unit. (☞ page 13)

❑ Select the mode to control

3 Press **[MENU]**, select “iPod Setup” using **[◀◀]** and **[▶▶]**, and press **[ENTER]**. (☞ page 19).

4 Select “iPod Ctrl” using **[◀◀]** and **[▶▶]**, and press **[ENTER]**. (☞ page 22)

5 Use **[◀◀]** and **[▶▶]** to select the mode.

[Selectable items]

- 1. Direct** : Control using the iPod.
- 2. Remote** : Control using this unit and the remote control.

Display mode		1. Direct	2. Remote
Display location		iPod display	Main unit display
Playable files	Audio file	○	○
	Video file	○	×
Active buttons	Remote control and Main unit (This unit)	○	○
	iPod	○	×

❑ Select the Database to playback

4 Select “Database” using **[◀◀]** and **[▶▶]**, display the database of the file you want to playback, and press **[ENTER]**. (☞ page 21)

5 Select the music file that you want to playback using **[◀◀]** and **[▶▶]**, and press **▶**. Playback starts.

❑ Remote control and iPod button relations

Remote control buttons	iPod buttons	Operation on the unit
▶	▶▶	Plays the track
⏸	⏸	Pause
■	–	Return to the first track in the folder
◀◀, ▶▶	◀◀, ▶▶	Skip to previous or next track Fast forward and rewind cannot be used
REPEAT	–	Switches the repeat function
RANDOM	–	Switches the shuffle function
AMS	–	Plays the first 10 seconds of the track, then skips to the next track
TEXT	–	Displays the file name

NOTE

- Marantz will accept no responsibility whatsoever for any loss of iPod data.
- Depending on the type of iPod and the software version, some functions may not operate.

❑ To Switch the Display

During playback, press **[TEXT]**. The display switches each time the button is pressed.



Disconnecting the iPod

1 Press **■**.

2 Disconnect the iPod cable from the USB port.

Symbols used to indicate buttons in this manual

- Button located on both the main unit and the remote control → **BUTTON**
- Button only on the main unit → **<BUTTON>**
- Button only on the remote control → **[BUTTON]**

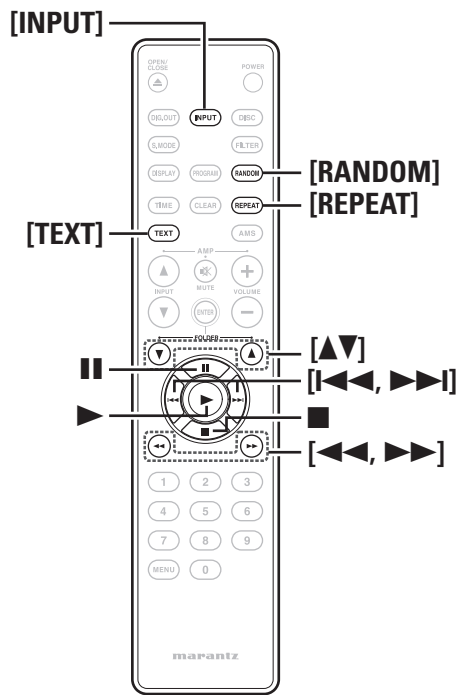
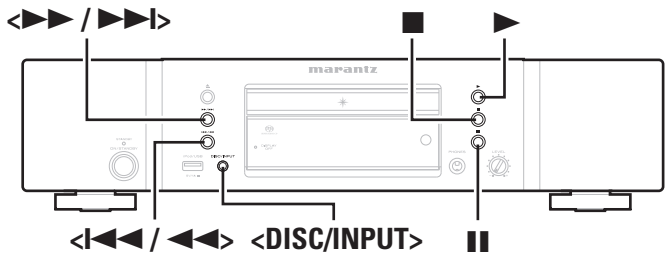

Playing a USB memory device

Playable USB memory formats

Files created in the following formats and stored on a USB memory device can be played.

❑ USB-Compatible file systems

- “FAT16” or “FAT32”
- If the USB memory device is divided into multiple partitions, only the top drive can be selected.

❑ Maximum number of playable files and folders

Maximum number of files in a folder: 65,535
Maximum number of folders: 700

❑ File format

- MP3 (MPEG-1 Audio Layer-3)
- WMA (Windows Media Audio)
- M4A (AAC)
- WAV (LINER PCM)

❑ Tag data

- ID3-Tags (Ver.1.x and 2.x)
- META-Tags (Compatible with title, artist and album names)

Playable MP3/WMA file			
File format	Sampling frequency	Bit rate	Extension
MP3	32, 44.1, 48 kHz	For MPEG-1 Audio Layer3, 32/40/48/56/64/80/96/112/128/160/192/224/256/320	.mp3
WMA	32, 44.1, 48 kHz	CBR: 48~320 VBR: Peak 384 (display corresponds to average bit rate value)	.wma
AAC	32, 44.1, 48 kHz	8~320 kbps	.m4a
LINER PCM	Linear PCM: PCM 32/44.1/48 Those other than the above, not supported.	Linear PCM: 16 bit	.wav

- Only music files that are not copyright-protected can be played on this set.
- Contents downloaded from pay sites on the Internet are copyright protected. Also, files encoded in WMA format when ripped from a CD, etc., on a computer may be copyright protected, depending on the computer’s settings.

Playing files stored on USB memory devices

- 1 Press **<DISC/INPUT>** or **[INPUT]** to change the input source to “USB”.
- 2 Connect the USB memory device to the USB terminal on the front panel of this unit. (See page 13)
- 3 Press **▶**. Playback starts.

To Switch the Folder or File During Playback

[Using the buttons on the main unit]

During playback, press **<◀◀/▶▶>** or **<▶▶/▶▶▶>**.

[Using the buttons on the remote control]

- **Folder**
Use **[▲, ▼]** to select the folder, then press **[ENTER]**.
- **File**
Use **[◀◀]** or **[▶▶]** to select the file.

[Pencil icon] The file numbers are set automatically when the USB memory device is loaded.

Stopping Playback

Press **■**.

Stopping Playback temporarily

- Press **||**.
- The “||” indicator lights.
- To restart playback, press **▶** or **||**.

Fast-Forwarding and Fast-Reversing (Searching)

[Using the buttons on the main unit]

- During playback, press and hold in **<◀◀◀/▶▶▶>** or **<▶▶▶▶▶>**.
- When you remove your finger from the button, normal playback is resumed.
- When normal playback is resumed after searching, the sound may be interrupted momentarily.

[Using the buttons on the remote control]

- During playback, press and hold in **[◀◀◀]** or **[▶▶▶]**.
- When you remove your finger from the button, normal playback is resumed.
- When normal playback is resumed after searching, the sound may be interrupted momentarily.

Playing a USB memory device

Playing repeatedly (Repeat playback)

Press [REPEAT].

Playing in random order (Random playback)

Press [RANDOM].

- Random playback will automatically start.
- To cancel random playback, press [RANDOM] or ■. The "RAND" indicator goes dark and random playback is canceled.

Switching the Display

During playback, press [TEXT].

Switching the Time Display

During playback, press [TIME].

NOTE

- Marantz will take no responsibility whatsoever for any loss or damage to data on a USB memory device when using it connected to the unit.
- USB memory devices will not work via a USB hub.
- Marantz does not guarantee that all USB memory devices will operate or be supplied power. When using a USB portable hard disk that can draw power from an AC adapter, we recommend using the AC adapter.

Removing the USB memory device

1 Press ■ to stop playback.

2 Check that the communication indicator on the USB memory device is not flashing, then pull out the USB memory device.

NOTE

Do not pull out the USB memory device if the communication indicator on the USB memory device is still flashing. Doing so may damage the USB memory device and the data recorded on the device.

Using as a D/A converter

Digital audio signals input from an external device or computer into this unit can be converted and output as analog signals using this unit. (D/A converter)

Connect and playback from a digital device (Coax/Opt)

Press <DISC/INPUT> or [INPUT] to change the input source to "Coax" or "Opt".

The input digital audio signal is displayed as shown.

"Coax : xxxx"

"Opt : xxxx"

xxxx indicates the sampling frequency.

- If the sampling frequency cannot be detected, the display flashes.

NOTE

- Linear PCM signals with sampling frequencies of 32 kHz, 44.1 kHz, 48 kHz, 64 kHz, 88.2 kHz, 96 kHz, 176.4 kHz and 192 kHz can be input in the unit.
- Do not input non-PCM signals, such as Dolby Digital, and DTS. This causes noise and could damage the speakers.
- If the sampling frequency switches, such as from A mode to B mode in a CS broadcast, muting may operate for 1-2 seconds, cutting the sound.

When the mode has been changed to disc input mode

Press <DISC/INPUT> or [DISC].

Connecting and playing back from a computer (USB)

Connect a computer to the USB port on the rear panel of this unit in advance. For details on how to connect the computer, see "PC connection" (☞ page 13).

Press <DISC/INPUT> or [INPUT] to change the input source to "PC".

When "PC: xxkHz" is displayed on this unit, wait for approximately 10 seconds, and then start and operate the music playback software on the computer.

This unit functions as a D/A converter.

NOTE

- Perform operations such as playback and pause on the computer. At this time, you cannot operate the computer with the unit's keys or remote control.
- You can also control the volume and equalizer on the computer. Enjoy playing music at the desired volume.
- When this unit is functioning as a D/A converter, sound is not output from the computer's speakers.
- If the computer is disconnected from this unit while the computer music playback software is running, the playback software may freeze. Always exit the playback software before disconnecting the computer.
- If an error occurs on the computer, restart the computer while it is still connected to the USB port of this unit.
- The supported sampling frequencies are 32/44.1/48/96 kHz.
- The sampling frequency of the music playback software and sampling frequency displayed on this unit may differ.

Computer (recommended system)**OS**

- Windows® XP Service Pack2 or more, Windows Vista or Windows 7
- Macintosh OSX 10.6.3

Software

- Server software supporting Windows Media Player and iTunes.

USB

- USB 2.0: USB Full speed/USB Audio Class1

Symbols used to indicate buttons in this manual

- Button located on both the main unit and the remote control → **BUTTON**
- Button only on the main unit → **<BUTTON>**
- Button only on the remote control → **[BUTTON]**

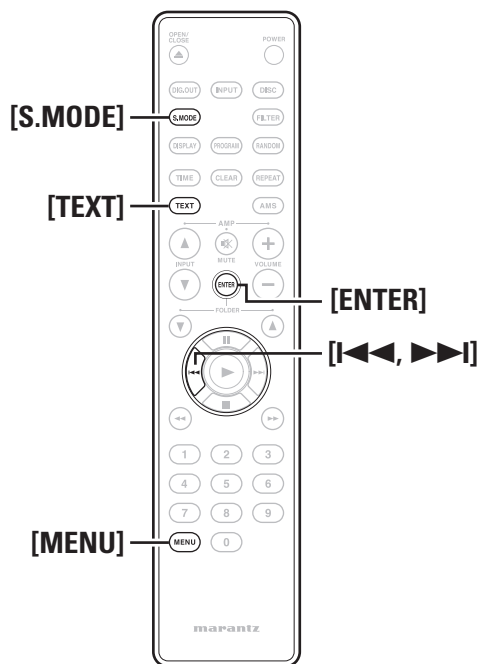

Performing menu settings

You can set the following functions. For further information, see the page indicated in parentheses ().

- 1** During stop mode, press **[MENU]**.
- 2** Press **[◀◀]** or **[▶▶]** to select the menu item you want to set.

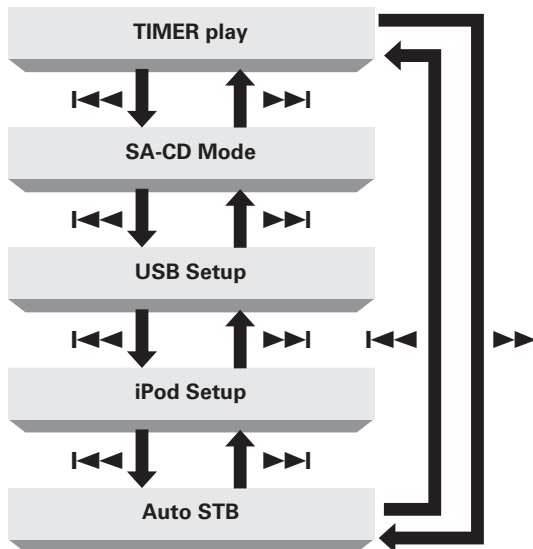

[Selectable items]

- Timer play (Timer play setting)**
Set the audio timer. (☞ page 19)
- SA-CD Mode (Switching Sound Mode)**
Set the layer of the hybrid CD. (☞ page 20)
- USB Setup (USB memory device operation)**
Set the file playback of the USB memory device. (☞ page 20)
- iPod Setup (iPod operation)**
Set the file playback of the iPod. (☞ page 21)
- Auto STB (Auto standby mode)**
Set the auto standby function. (☞ page 22)

- 3** Press **[ENTER]**.

NOTE

Menu settings cannot be adjusted when the unit is in Repeat Play or Random Play modes.

Timer play (Timer play setting)

This unit can perform timer play by cooperating with your audio timer.

- 1** Insert the media to playback into the unit.
 - 2** Select “TIMER Play=>” using **[◀◀]** and **[▶▶]**, and press **[ENTER]**.
 - 3** Select On or Off for the timer play settings using **[◀◀]** and **[▶▶]**, and press **[ENTER]**.
- [Selectable items]**
- Off** : Timer play is not set.
 - On** : Timer play is set.
- 4** When ON is set, select the playback media using **[◀◀]** and **[▶▶]**, and press **[ENTER]**.

[Selectable items]

- CD/SA-CD** : Plays back the DISC media.
- USB/iPod** : Plays back the USB memory device.

- 5** Press **[MENU]**.
Saves the timer play settings.
- 6** Set the audio timer.

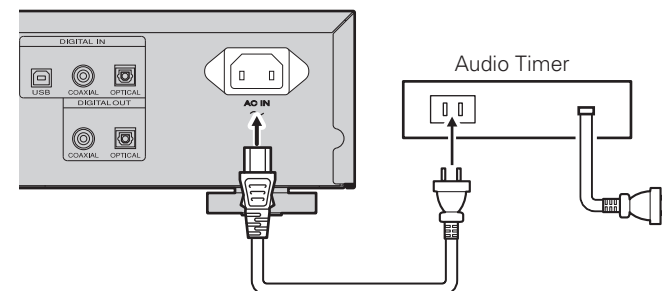

NOTE

For connection to audio timer and its operation, please refer to the instruction manual of your audio timer.

SA-CD (Switching sound mode)

Switching "Start Sound Mode"

The Start Sound Mode can be switched over in the following hierarchical scheme.

1 Select "SA-CD Mode=>" using [◀◀] and [▶▶], and press [ENTER].

2 Select the layer to playback using [◀◀] and [▶▶], and press [ENTER].

[Selectable items]

SA-CD :

If a Super Audio CD hybrid layer disc is inserted, the Super Audio CD layer is read. (default mode)

Switch to the CD layer by pressing the [S.MODE].

Switch back to the Super Audio CD layer by pressing the [S.MODE] once again.

CD :

If a Super Audio CD hybrid layer disc is inserted, the CD layer is read.

Sound Mode cannot be switched even if the [S.MODE] is pressed.

If a disc with only a Super Audio CD area is inserted, the Super Audio CD layer is read.

3 Press [MENU].
Saves the Start Sound Mode settings.

NOTE

Menu settings cannot be adjusted when the unit is in Repeat Play or Random Play modes.

USB Setup (USB memory device operation)

The USB memory device works in the following hierarchical logic.

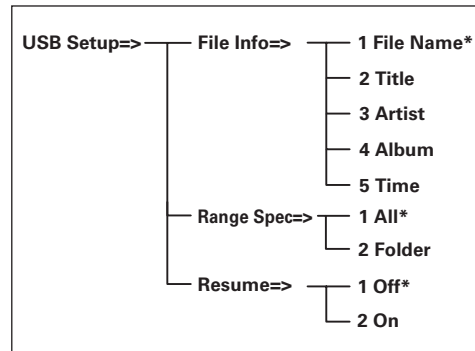

* Default setting

File Info (File information display selection)

You can view MP3 tags and other file information when playing a USB memory device.

1 Select "USB Setup =>" using [◀◀] and [▶▶], and press [ENTER].

2 Select "File Info =>" using [◀◀] and [▶▶], and press [ENTER].

3 Select the information you want to display using [◀◀] and [▶▶], and press [ENTER].

[Selectable items]

1. File Name : The file name is displayed.

2. Title : The track name is displayed.

3. Artist : The artist name is displayed.

4. Album : The album name is displayed.

5. Time : The time information is displayed.

4 Press [MENU].
The display exits.

- Press the [TEXT] during normal playback to view selected file information.
- Press the [TEXT] again to view the track title. If "track title" was the selected file information option, then the artist name will be displayed.
- Each time the [TEXT] is pressed, the display changes in the following order:

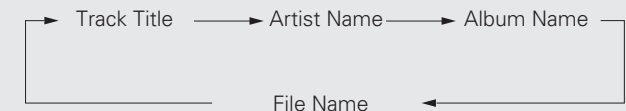

Range Spec. (Selecting a range of files to be played)

You can select whether all files in USB memory device or the files in a specific folder are to be played.

1 Select "USB Setup =>" using [◀◀] and [▶▶], and press [ENTER].

2 Select "Range Spec =>" using [◀◀] and [▶▶], and press [ENTER].

3 Select the range you want to playback using [◀◀] and [▶▶], and press [ENTER].

[Selectable items]

1. All : Plays back all of the files on the USB memory device.

2. Folder : Plays back the files in the selected folder.

4 Press [MENU].
The playback range settings are saved.

Symbols used to indicate buttons in this manual

- Button located on both the main unit and the remote control → **BUTTON**
- Button only on the main unit → **<BUTTON>**
- Button only on the remote control → **[BUTTON]**

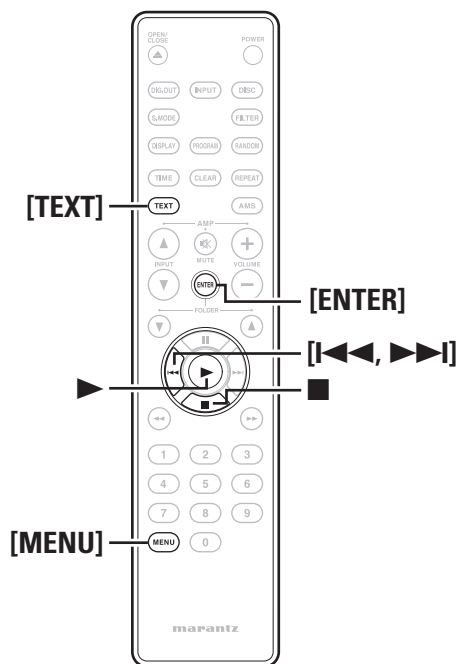

Resume (Playing tracks from where they were previously stopped)

- 1 Select "USB Setup =>" using [**⏪**] and [**⏩**], and press [**ENTER**].
 - 2 Select "Resume =>" using [**⏪**] and [**⏩**], and press [**ENTER**].
 - 3 Select On or Off for the resume playback settings using [**⏪**] and [**⏩**], and press [**ENTER**].
- [Selectable items]**
1. **Off** : Resume playback is not set.
 2. **On** : Resume playback is set.
- 4 Press [**MENU**].
Saves the resume playback settings.

NOTE

- Resume Play only works when an identical USB memory device is inserted. If another USB memory device is inserted, the unit will start playing from the first file.
- The unit may not play your desired file if files have been added to or deleted from the identical USB memory device.

iPod Setup (iPod operation)

The iPod works in the following hierarchical logic.

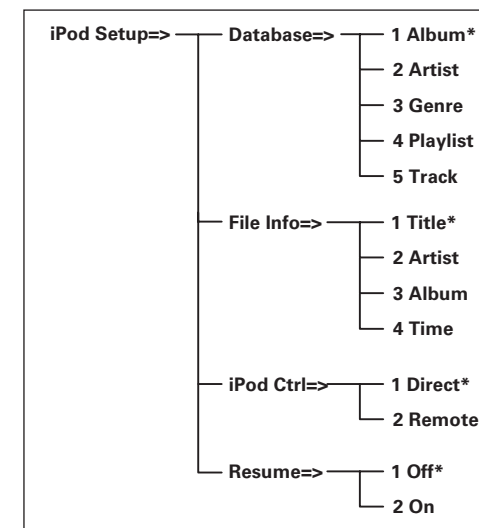

* Default setting

Database (iPod database selection)

- 1 Select "iPod Setup =>" using [**⏪**] and [**⏩**], and press [**ENTER**].
 - 2 Select "Database =>" using [**⏪**] and [**⏩**], and press [**ENTER**].
 - 3 Select the database from which you want to playback files using [**⏪**] and [**⏩**], and press [**ENTER**].
- [Selectable items]**
- 1 Album / 2 Artist / 3 Genre / 4 Playlist / 5 Track
- 4 Select the music file that you want to playback using [**⏪**] and [**⏩**], and press **▶**.
Playback starts.

NOTE

- This setting can be made when "iPod Ctrl" is set to "Remote".
- Playback will be resumed from the beginning of the current file.

File Info (File information display selection)

You can view file information when playing iPod files.

1 Select “iPod Setup =>” using [◀◀] and [▶▶], and press [ENTER].

2 Select “File info =>” using [◀◀] and [▶▶], and press [ENTER].

3 Select the information you want to display using [◀◀] and [▶▶], and press [ENTER].

[Selectable items]

- 1. Title** : The track name is displayed.
- 2. Artist** : The artist name is displayed.
- 3. Album** : The album name is displayed.
- 4. Time** : The time information is displayed.

4 Press [MENU].
The settings are saved.

- Press the [TEXT] during normal playback to view selected file information.
- Press the [TEXT] again to view the track title. If “track title” was the selected file information option, then the artist name will be displayed.
- Each time the [TEXT] is pressed, the displayed information changes in the following order:

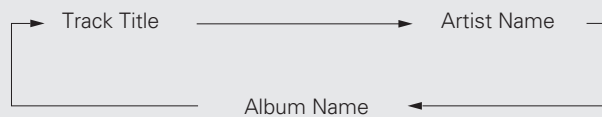

NOTE

This setting can be made when “iPod Ctrl” is set to “Remote”.

iPod Ctrl (Operating an iPod with its own controls)

You can specify whether operation of an iPod is performed with its own controls or from this unit.

1 Select “iPod Setup =>” using [◀◀] and [▶▶], and press [ENTER].

2 Select “iPod Ctrl =>” using [◀◀] and [▶▶], and press [ENTER].

3 Select the device that you want to control using [◀◀] and [▶▶], and press [ENTER].

[Selectable items]

- 1. Direct** : Control using the iPod.
- 2. Remote** : Control using this unit and the remote control.

4 Press [MENU].
The device control settings are saved.

NOTE

With the “1 Direct” setting, you can use the Play, Pause, Next, Previous, and Stop commands from the remote control. When a 1G Nano or 5G iPod is connected with the “1 Direct” setting, the setting will be automatically changed to “2 Remote” as these models do not support this function.

Resume (Playing tracks from where they were previously stopped)

1 Select “iPod Setup =>” using [◀◀] and [▶▶], and press [ENTER].

2 Select “Resume =>” using [◀◀] and [▶▶], and press [ENTER].

3 Select On or Off for the resume playback settings using [◀◀] and [▶▶], and press [ENTER].

[Selectable items]

- 1. Off** : Resume playback is not set.
- 2. On** : Resume playback is set.

4 Press [MENU].
Saves the resume playback settings.

NOTE

Playback will be resumed from the beginning of the current file.

Auto STB (Auto standby mode)

With Auto Standby On, you can automatically set this unit to standby mode after the unit is in stop mode continuously for about 30 minutes (no operation).

1 Select “Auto STB =>” using [◀◀] and [▶▶], and press [ENTER].

2 Select On or Off for the auto standby function using [◀◀] and [▶▶], and press [ENTER].

[Selectable items]

- On** : Enable Auto Standby mode.
- Off** : Disable Auto Standby mode.

3 Press [MENU].
Saves the auto standby function settings.

NOTE

When the Input Source of this unit is set to “PC”, the Auto STB function may not work properly depending on the applications of your PC.

Explanation of terms

B

Bit rate

This expresses the read amount per 1 second of video/audio data recorded in a disc.

M

MP3 (MPEG AudioPlayer 3)

This is an internationally standardized audio data compression scheme, using the "MPEG-1" video compression standard. It compresses the data volume to about one eleventh its original size while maintaining sound quality equivalent to a music CD.

S

Sampling frequency

Sampling involves taking a reading of a sound wave (analog signal) at regular intervals and expressing the height of the wave at each reading in digitized format (producing a digital signal).

The number of readings taken in one second is called the "sampling frequency". The larger the value, the closer the reproduced sound is to the original.

Super audio CD

There are three types of Super Audio CDs:

- ① Single layer discs
Single layer Super Audio CD with just an HD layer.
- ② Dual layer discs
Super Audio CD with a double HD layer, offering extended playing time and high sound quality.
- ③ Hybrid discs
Two-layer Super Audio CD with an HD layer and a CD layer.
The signals on the CD layer can be played on a regular CD player.

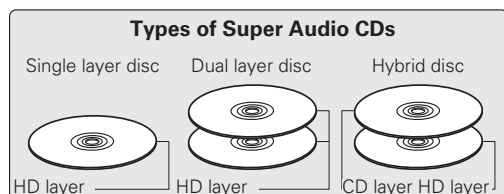

- **What is the HD layer?**

The HD layer is a layer of high density signals for Super Audio CDs.

- **What is the CD layer?**

The CD layer is the layer of signals that can be read on a regular CD player.

W

WMA (Windows Media Audio)

This is audio compression technology developed by Microsoft Corporation.

WMA data can be encoded using Windows Media® Player Ver.7, 7.1, Windows Media® Player for Windows® XP and Windows Media® Player 9 Series.

To encode WMA files, only use applications authorized by Microsoft Corporation. If you use an unauthorized application, the file may not work properly.

Troubleshooting

If a problem occurs, first check the following:

1. Are the connections correct?

2. Is the unit being operated as described in the owner's manual?

If this unit does not operate properly, check the items listed in the table below. If the problem persists there may be a malfunction.

In this case, disconnect the power immediately and contact the retail outlet.

Problem	Cause	Corrective action	Page
The disc fails to rotate.	• The power cord is pulled out of the socket.	• Insert the power cord plug into the socket.	7
	• Power to this unit is not ON.	• Turn the power to this unit ON.	8
	• The disc is not placed in the correct position on the disc tray.	• Place the disc in the disc tray correctly.	3
	• The disc is placed in upside down. (The disc is placed in with the label facing down).	• Place the disc in the disc tray correctly.	3
The disc stops rotating in mid-operation.	• The disc is dirty.	• Clean the disc's surface.	4
	• The disc is scratched.	• The disc may be unable to be played if it has a lot of scratches.	–
	• The disc is warped.	• The disc may be unable to be played if it is badly warped.	–
The disc is rotating but no sound is heard.	• The amplifier and speakers are not connected correctly.	• Connect the cables correctly. (See the instruction manual for the amplifier.)	7
	• The amplifier power is not ON.	• Turn ON the power to the amplifier. (See the instruction manual for the amplifier.)	–
	• The amplifier's function or selector switch is not set to "CD" or "AUX" or such (to whatever you have connected this unit to).	• Switch the amplifier's function or selector switch to "CD" or "AUX" or such (to whatever you have connected this unit to). (See the instruction manual for the amplifier.)	–
	• The amplifier's volume control is set at the minimum level.	• Adjust the amplifier volume. (See the instruction manual for the amplifier.)	–

Problem	Cause	Corrective action	Page
Remote control operation is not possible.	• The distance between this unit and the remote control is too great.	• Move closer to this unit, and operate the remote control within the operating range.	4
	• There is an obstacle between this unit and the remote control.	• Remove the obstacle.	4
	• The remote control's batteries are dead.	• Replace all batteries with new ones.	4
	• A strong light is hitting the unit's sensor window.	• Do not let strong light hit the sensor window.	4
CD-R/CD-RW disc cannot be played.	• The disc is placed in upside down.	• Place the disc in the tray correctly.	3
	• The information recorded is not in an audio (CD-DA) format. Or the MP3/WMA file was not properly recorded.	• Record correct information that is compatible with this unit.	14
Cannot switch the sound mode of an SA-CD hybrid layer disc.	• Start Sound Mode is set to CD.	• Change Start Sound Mode setting to Super Audio CD.	20
Sound is too quiet when signals are output from a PC.	• The PC volume is turned down.	• Turn the PC volume up.	18

[USB memory device/iPod]

Problem	Cause	Corrective action	Page
"OverCurrent" appears on the display.	• The voltage able to be supplied from this unit via the USB memory device has been exceeded.	• The USB memory device is not supported. Please use a USB memory device with an operating current that is less than 1 A.	-
"FAT Error" or "Cluster Err" appear on the display.	• An unsupported file system is being used. USB memory device below 128 MB cannot be supported.	• Please use a USB memory device formatted with a compatible file system (FAT32 or FAT16) and that has at least 256 MB of memory.	-
"No File" appears on the display.	• No file able to be played on this unit exists.	• Check supported formats.	14, 17
"DRM Stream" appears on the display.	• This is a file subject to digital rights management.	• Cannot play on this unit because of unsupported DRM.	15, 17
The sound of the USB memory device being connected is not heard.	• The amplifier and speakers are not connected properly.	• Connect the cables correctly. (See the instruction manual for the amplifier.)	-
	• The amplifier power is not ON.	• Turn the amplifier power ON. (See the instruction manual for the amplifier.)	-
	• The amplifier's function or selector switch is not set to "CD" or "AUX" or such (to whatever you have connected this unit to).	• Switch the amplifier's function or selector switch to "CD" or "AUX" or such (to whatever you have connected this unit to). (See the instruction manual for the amplifier.)	-
	• The amplifier's volume control is set at the minimum level.	• Adjust the amplifier volume. (See the instruction manual for the amplifier.)	-

Problem	Cause	Corrective action	Page
The sound of the iPod being connected is not heard.	• The amplifier and speakers are not connected correctly.	• Connect the cables correctly. (See the instruction manual for the amplifier.)	-
	• The amplifier power is not ON.	• Turn ON the power to the amplifier. (See the instruction manual for the amplifier.)	-
	• The amplifier's function or selector switch is not set to "CD" or "AUX" or such (to whatever you have connected this unit to).	• Switch the amplifier's function or selector switch to "CD" or "AUX" or such (to whatever you have connected this unit to). (See the instruction manual for the amplifier.)	-
	• The amplifier's volume control is set at the minimum level.	• Adjust the amplifier volume. (See the instruction manual for the amplifier.)	-
Reading of USB memory device takes time.	• When connecting a high-capacity USB memory device, it will take time to read depending on its capacity. Several minutes may be required for reading when using a high-capacity device.	• Wait until reading is completed.	-

Specifications

□ Audio performance

	[Super Audio CD]	[CD]
• Analog output		
Channels:	2 channels	2 channels
Playable frequency range:	2 Hz – 100 kHz	2 Hz – 20 kHz
Playable frequency response:	2 Hz – 50 kHz (–3 dB)	2 Hz – 20 kHz
S/N:	112 dB (Audible range)	110 dB
Dynamic range:	110 dB (Audible range)	100 dB
Harmonic distortion:	0.001 % (1 kHz, Audible range)	0.002 % (1 kHz)
Wow & flutter:	Crystal accuracy	Crystal accuracy
• Output level		
Unbalanced:	1.8V RMS stereo	2.4V RMS stereo
Headphone output:	43mW (variable maximum)	43mW (variable maximum)
• Digital output		
output level (cinch JACK):	—	0.5 Vp-p (75 Ω)
output level (optical):	—	-19 dBm
• Optical Readout System		
Laser:	AlGaAs	AlGaAs
Wave length:	650nm	780nm
Signal type:	1-bit DSD	16-bit linear PCM
Sampling frequency:	2.822 MHz	44.1 kHz

□ General

Power supply:	AC 230 V, 50 Hz/60 Hz
Power consumption:	25 W
	Standby: 0.3 W or less
Maximum external dimensions:	440 (W) x 108.5 (H) x 343.5 (D) mm
Weight:	7.8 kg
Operating temperatures:	+5°C ~ +35°C
Operating humidity:	5 ~ 90% (without dew)

※ For purposes of improvement, specifications and design are subject to change without notice.

Index

☞ Numerics

1-track repeat 10

☞ A

All-track repeat 10
 AMS play 11
 Analog connection 7
 Auto standby mode 22

☞ B

Batteries 4
 Bit rate 14, 17, 23

☞ C

Cable 7, 12
 Audio cables 7, 12
 Coaxial digital cable 12
 iPod cable 12
 Optical cable 12
 Power cord 7
 Remote connector cord 12, 14
 USB cable 12
 CD-R/CD-RW 3, 15
 Connections
 Analog connections 7
 Coaxial digital connections 12
 Connecting cables 7, 12
 iPod 13
 Optical digital connections 12
 PC 13
 Power cord 7
 Remote control 14
 USB memory device 13

☞ D

Direct searching 10
 Display 10

☞ E

EXTERNAL 14

☞ F

Fast-forwarding 9, 17
 Fast-reversing 9, 17
 Finalize 3

☞ I

INTERNAL 14
 iPod Setup 21

☞ M

MP3 14, 15, 17, 23
 Music CDs 3

☞ P

Playback
 Playback CDs 9
 Playback iPod 16
 Program playback 11
 Random playback 10, 18
 Repeat playback 10, 18
 Stopping playback 9, 17
 Stopping playback temporarily 9, 17
 USB playback 17
 Playback layer 8
 Power cord 7
 Program playback 11

☞ R

Random playback 10, 18
 Remote control 6
 Inserting the batteries 4
 Remote control connection 14
 Repeat playback 10, 18

☞ S

Sampling frequency 14, 17, 23
 Searching 9, 17
 Skipping 10
 Stopping playback 9, 17
 Super Audio CD 3, 23
 Switching the input source 9

☞ T

Timer play setting 19

☞ W

WMA 14, 15, 17, 23







• SA-KI-PEARL-LITE (unit: mm)

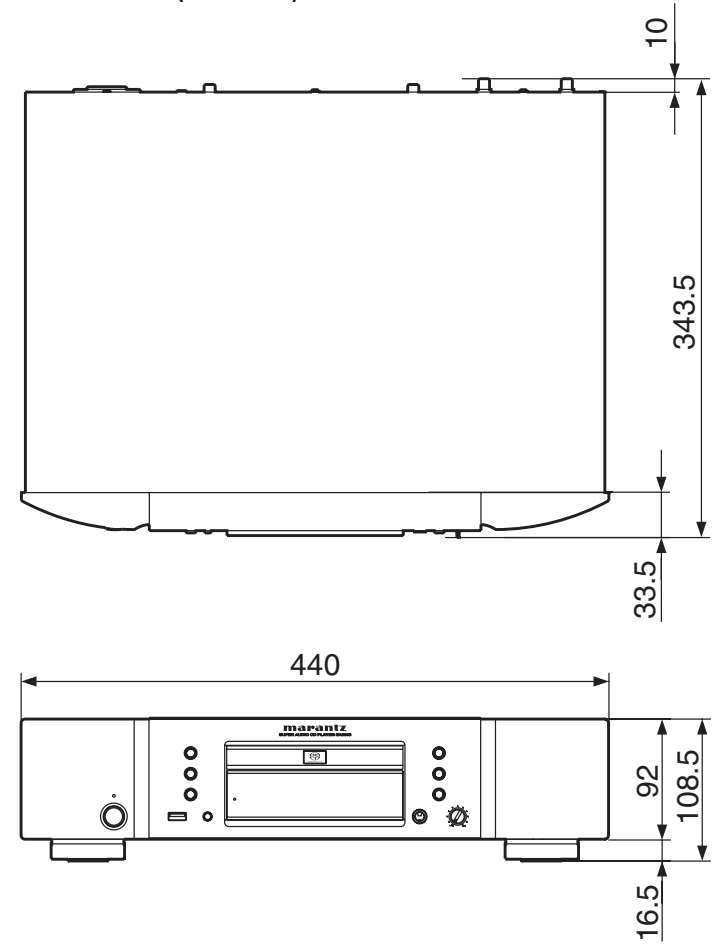

www.marantz.com

You can find your nearest authorized distributor or dealer on our website.

marantz[®] is a registered trademark.