

# marantz®

## Model PM-15S1 User Guide

---

Integrated Amplifier

## ENGLISH

### **WARRANTY**

For warranty information, contact your local Marantz distributor.

### **RETAIN YOUR PURCHASE RECEIPT**

Your purchase receipt is your permanent record of a valuable purchase. It should be kept in a safe place to be referred to as necessary for insurance purposes or when corresponding with Marantz.

### **IMPORTANT**

When seeking warranty service, it is the responsibility of the consumer to establish proof and date of purchase. Your purchase receipt or invoice is adequate for such proof.

### **FOR U.K. ONLY**

This undertaking is in addition to a consumer's statutory rights and does not affect those rights in any way.

## FRANÇAIS

### **GARANTIE**

Pour des informations sur la garantie, contacter le distributeur local Marantz.

### **CONSERVER L'ATTESTATION D'ACHAT**

L'attestation d'achat est la preuve permanente d'un achat de valeur. La conserver en lieu sûr pour s'y reporter aux fins d'obtention d'une couverture d'assurance ou dans le cadre de correspondances avec Marantz.

### **IMPORTANT**

Pour l'obtention d'un service couvert par la garantie, il incombe au client d'établir la preuve de l'achat et d'en corroborer la date. Le reçu ou la facture constituent des preuves suffisantes.

## DEUTSCH

### **GARANTIE**

Bei Garantiefragen wenden Sie sich bitte an Ihren Marantz-Händler.

### **HEBEN SIE IHRE QUITTING GUT AUF**

Die Quittung dient Ihnen als bleibende Unterlage für Ihren wertvollen Einkauf. Das Aufbewahren der Quittung ist wichtig, da die darin enthaltenen Angaben für Versicherungszwecke oder bei Korrespondenz mit Marantz angeführt werden müssen.

### **WICHTIG!**

Bei Garantiefragen muß der Kunde eine Kaufunterlage mit Kaufdatum vorlegen. Ihren Quittung oder Rechnung ist als Unterlage ausreichend.

## NEDERLANDS

### **GARANTIE**

Voor inlichtingen omtrent garantie dient u zich tot uw plaatselijke Marantz.

### **UW KWITANTIE, KASSABON E.D. BEWAREN**

Uw kwitantie, kassabon e.d. vormen uw bewijs van aankoop van een waardevol artikel en dienen op een veilige plaats bewaard te worden voor evt. verwijzing bijv. in verband met verzekering of bij correspondentie met Marantz.

### **BELANGRIJK**

Bij een evt. beroep op de garantie is het de verantwoordelijkheid van de consument een gedateerd bewijs van aankoop te tonen. Uw kassabon of factuur zijn voldoende bewijs.

## ESPAÑOL

### **GARANTIA**

Para obtener información acerca de la garantía póngase en contacto con su distribuidor Marantz.

### **GUARDE SU RECIBO DE COMPRA**

Su recibo de compra es su prueba permanente de haber adquirido un aparato de valor. Este recibo deberá guardarlo en un lugar seguro y utilizarlo como referencia cuando tenga que hacer uso del seguro o se ponga en contacto con Marantz.

### **IMPORTANTE**

Cuando solicite el servicio otorgado por la garantía el usuario tiene la responsabilidad de demostrar cuándo efectuó la compra. En este caso, su recibo de compra será la prueba apropiada.

## ITALIANO

### **GARANZIA**

L'apparecchio è coperto da una garanzia di buon funzionamento della durata di un anno, o del periodo previsto dalla legge, a partire dalla data di acquisto comprovata da un documento attestante il nominativo del Rivenditore e la data di vendita. La garanzia sarà prestata con la sostituzione o la riparazione gratuita delle parti difettose.

Non sono coperti da garanzia difetti derivanti da uso improprio, errata installazione, manutenzione effettuata da personale non autorizzato o, comunque, da circostanze che non possano riferirsi a difetti di funzionamento dell'apparecchio. Sono inoltre esclusi dalla garanzia gli interventi inerenti l'installazione e l'allacciamento agli impianti di alimentazione.

Gli apparecchi verranno riparati presso i nostri Centri di Assistenza Autorizzati. Le spese ed i rischi di trasporto sono a carico del cliente.

La casa costruttrice declina ogni responsabilità per danni diretti o indiretti provocati dalla inosservanza delle prescrizioni di installazione, uso e manutenzione dettagliate nel presente manuale o per guasti dovuti ad uso continuato a fini professionali.

## PORTUGUÊS

### **GARANTIA**

Para informações sobre a garantia, contactar o distribuidor Marantz local.

### **GUARDAR O RECIBO DE COMPRA**

O recibo é o registo permanente da compra que fez. Deve ser guardado num local seguro, para ser apresentado em questões relacionadas com o seguro ou para quando tiver de contactar a Marantz.

### **IMPORTANTE**

Quando procurar assistência técnica ao abrigo da garantia, é da responsabilidade do consumidor estabelecer a prova e data de compra. O recibo é prova adequada.

## SVENSKA

### **GARANTI**

För information om garantin, kontakta Marantz lokalagent.

### **SPAR KVITTOT**

Kvittot är ett inköpsbevis på en värdefull vara. Det skall förvaras säkert och hänvisas till vid försäkringsfall eller vidkorrespondens mod Marantz.

### **VIKTIGT**

Fö att garantin skall gälla är det kundens sak att framställa bevis och datum om köpet. Kvitto eller faktura är tillräckligt bevis för detta.

## DANSK

### **GARANTI**

Henvend dem til Deres MARANTZ-forhandler angående information om garantien.

### **GEM DERES KVITTERING**

Deres købskvittering er Deres varige bevis på et dyrt køb. Den bør gemmes godt og anvendes som bevis, hvis De vil tegne en forsikring, eller hvis De kommunikerer med Marantz.

### **VIGTIGT**

Det påhviler forbrugeren at skaffe bevis for købet og købsdatoen, hvis han eller hun ønsker garantiservice. Deres købskvittering eller faktura er et fulgyldigt bevis herpå.

# CE MARKING

- English**  
The PM-15S1 is in conformity with the EMC directive and low-voltage directive.
- Français**  
Le PM-15S1 est conforme à la directive EMC et à la directive sur les basses tensions.
- Deutsch**  
Das Modell PM-15S1 entspricht den EMC-Richtlinien und den Richtlinien für Niederspannungsgeräte.
- Nederlands**  
De PM-15S1 voldoet aan de EMC eisen en de vereisten voor laag-voltage.
- Español**  
El PM-15S1 está de acuerdo con las normas EMC y las relacionadas con baja tensión.
- Italiano**  
Il PM-15S1 è conforme alle direttive CEE ed a quelle per i bassi voltaggi.
- Português**  
O PM-15S1 conforma com as diretrizes EMC e de baixa voltagem.
- Svenska**  
PM-15S1 är tillverkad i enlighet med EMC direktiven och direktiven för lågvoltstrusning.
- Dansk**  
Model PM-15S1 er i overensstemmelse med EMC-direktivet og direktivet om lavspænding.

## English

### WARNINGS

- Do not expose the equipment to rain or moisture.
- Do not remove the cover from the equipment.
- Do not insert anything into the equipment through the ventilation holes.
- Do not handle the mains lead with wet hands.
- Do not cover the ventilation with any items such as tablecloths, newspapers, curtains, etc.
- No naked flame sources, such as lighted candles, should be placed on the equipment.
- When disposing of used batteries, please comply with governmental regulations or environmental public instruction's rules that apply in your country or area.
- Do not place anything about 0.2 meter above the top panel.
- Make a space of about 0.1 meter around the unit.
- No objects filled with liquids, such as vases, shall be placed on the apparatus.
- When the switch is in the OFF position, the equipment is not completely switched off from MAINS.

## Français

### AVERTISSEMENTS

- Ne pas exposer l'appareil à la pluie ni à l'humidité.
- Ne pas essayer de retirer le boîtier de l'appareil.
- Ne rien insérer dans l'appareil par les orifices de ventilation.
- Ne pas manipuler le cordon d'alimentation avec les mains mouillées.
- Ne pas recouvrir les ouïes de ventilation avec un objet quelconque comme une nappe, un journal, un rideau, etc.
- Ne placer aucune source de flamme nue, comme une bougie allumée, sur l'appareil.
- Pour mettre au rebut les piles usées, respecter les lois gouvernementales ou les règlements officiels concernant l'environnement qui s'appliquent à votre pays ou région.
- Ne placez aucun objet à moins de 0,2 mètre environ du panneau supérieur.
- Veillez à ce qu'aucun objet ne soit à moins de 0,1 mètre des côtés de l'appareil.
- Aucun objet rempli de liquide, un vase par exemple, ne doit être placé sur l'appareil.
- Lorsque l'interrupteur est sur la position OFF, l'appareil n'est pas complètement déconnecté du SECTEUR (MAINS).

## Deutsch

### WARNHINWEISE

- Das Gerät nicht Regen oder Feuchtigkeit aussetzen.
- Die Abdeckung nicht vom Gerät abnehmen.
- Keine Gegenstände durch die Belüftungsschlitze stecken.
- Das Netzkabel nicht mit feuchten oder nassen Händen anfassen.
- Decken Sie die Lüftungsöffnungen nicht mit einem Tischtuch, einer Zeitung, einem Vorhang usw. ab.
- Es dürfen keine Gegenstände mit offener Flamme, wie etwa brennende Kerzen, auf dem Gerät aufgestellt werden.
- Beachten Sie bei der Entsorgung der verbrauchten Batterien alle geltenden lokalen und überregionalen Regelungen.
- Darauf achten, daß über dem Gerät ein Freiraum von mindestens 0,2 meter vorhanden ist.
- Auf allen Geräteseiten muß ein Zwischenraum von ungefähr 0,1 meter vorhanden sein.
- Auf das Gerät dürfen keine mit Flüssigkeiten gefüllte Behälter, wie etwa eine Vase, gestellt werden.
- Wenn der Schalter ausgeschaltet ist (OFF-Position), ist das Gerät nicht vollständig vom Stromnetz (MAINS) abgetrennt.

## Nederlands

### WAARSCHUWINGEN

- Stel het apparaat niet bloot aan regen of vocht.
- Verwijder de afdekplaat van het apparaat niet.
- Duw niets door de ventilatieopeningen in het apparaat.
- Raak het netsnoer niet met natte handen aan.
- Bedek de ventilatieopeningen niet met enige voorwerpen, zoals tafelkleden, kranten, gordijnen, enz.
- Plaats geen brandende voorwerpen, zoals kaarsen, op het apparaat.
- Volg bij het weggooien van verbruikte batterijen de overheidswetgeving of milieuvorschriften op die van kracht zijn in het land of de regio waarin u zich bevindt.
- Zorg dat er tenminste 0,2 meter vrije ruimte boven het toestel is.
- Zorg dat er 0,1 meter vrije ruimte rond het toestel is.
- Plaats geen voorwerpen met een vloeistof erin, zoals een bloemenvaas, op het apparaat.
- Als de schakelaar op OFF staat, is het apparaat niet volledig losgekoppeld van de netspanning (MAINS).

## **Español**

### **ADVERTENCIAS**

- No esponga el equipo a la lluvia ni a la humedad.
- No extraiga la tapa del equipo.
- No introduzca nada en el interior del equipo a través de los orificios de ventilación.
- No maneje el cable de alimentación con las manos mojadas.
- No cubra la ventilación con objetos como manteles, periódicos, cortinas, etc.
- No deben colocarse sobre el equipo elementos con fuego, por ejemplo velas encendidas.
- Cuando se eliminen baterías usadas, deben cumplirse las reglamentaciones oficiales o las normas de protección medioambiental aplicables en su país o en su zona.
- No ponga nada a menos de 0,2 metro por encima del panel superior.
- Deje un espacio de unos 0,1 metro alrededor de la unidad.
- No se deben colocar sobre el aparato recipientes que contengan líquidos, como por ejemplo jarrones.
- Cuando el interruptor está en la posición OFF, el equipo no está completamente desconectado de la alimentación MAINS.

## **Italiano**

### **AVVERTENZE**

- Non esporre l'apparecchio alla pioggia o all'umidità.
- Non rimuovere il coperchio dell'apparecchio.
- Non introdurre oggetti all'interno dell'apparecchio attraverso i fori di ventilazione.
- Non toccare il cavo di alimentazione con le mani bagnate.
- Non coprire le fessure di ventilazione con tovaglie, giornali, tende od oggetti analoghi.
- Non posare sull'apparecchio sorgenti di fiamme scoperte quali candele accese.
- Smaltire le pile usate in conformità alle norme governative o disposizioni ambientali vigenti nel proprio paese o zona.
- Non posare alcun oggetto sopra il pannello superiore, lasciando libero uno spazio di circa 0,2 m.
- Lasciare 0,1 metro liberi tutto intorno l'unità.
- Non mettere sull'apparecchiatura alcun contenitore di liquido, come ad esempio dei vasi.
- Quando l'interruttore è nella posizione OFF, l'apparecchiatura non è completamente scollegata da MAINS.

## **Português**

### **ADVERTÊNCIAS**

- Não exponha o equipamento à chuva nem à humidade.
- Não retire a tampa do equipamento.
- Não atire nada para dentro do equipamento através dos orifícios de ventilação.
- Não manuseie o cabo de alimentação com as mãos molhadas.
- Não cobrir os orifícios de ventilação com objectos tais como toalhas de mesa, jornais, cortinas, etc.
- Não colocar chamas abertas tais como velas acesas, sobre o aparelho.
- Ao deitar foras as pilhas usadas, favor observar os regulamentos governamentais ou as regras com respeito ao meio ambiente que se aplicam no seu país ou área de residência.
- Deixar um espaço completamente livre de cerca de 0,2 metro acima do painel superior.
- Deixar um espaço de cerca de 0,1 metro ao redor do aparelho.
- Não colocar recipientes com água, tal como vasos, sobre o aparelho.
- Quando o interruptor está na posição OFF, o equipamento não fica totalmente desligado de MAINS.

## **Svenska**

### **VARNINGAR**

- Utsätt inte utrustningen för regn eller fukt.
- Ta inte bort utrustningens hölje.
- För inte in föremål i utrustningen genom ventilationshålen.
- Hantera inte nätsladden med våta händer.
- Täck inte för ventilationsöppningarna med några föremål som till exempel bordsdukar, dagstidningar, gardiner e.d.
- Inga föremål med öppen låga, som till exempel tända stearinljus, bör placeras på utrustningen.
- Följ de lagar och miljöskyddsråd som gäller i det land eller område där du bor när du gör dig av med batterier.
- Placera inte någonting närmare än 0,2 meter ovanför apparaten eller enheten.
- Se till att det finns omkring 0,1 meter fri plats runt omkring enheten.
- Inga objekt som är fyllda med någon vätska, till exempel blomstervaser, bör placeras på apparaten.
- Även om strömbrytaren står i det avstängda läget OFF, så är utrustningen inte helt bortkopplad från det elektriska nätet (MAINS).

## **Dansk**

### **ADVARSLER**

- Udsæt ikke udstyret for regn eller fugt.
- Fjern ikke dækslet fra udstyret.
- Stik ikke noget ind i udstyret gennem ventilationshullerne.
- Rør ikke ved netledningen med våde hænder.
- Tildæk ikke ventilationsåbningerne med ting som duge, aviser, gardiner og lignende.
- Kilder til åben ild, som for eksempel tændte stearinlys, må ikke anbringes på apparatet.
- Når du skiller dig af med gamle batterier, bedes du gøre dette i overensstemmelse med de love, regler og miljømæssige forskrifter, som er gældende i dit land eller område.
- Anbring ikke noget nærmere end 0,2 m over apparatets overside.
- Sørg for, at der er et frit område på omkring 0,1 m omkring apparatet.
- Der må ikke stilles genstande, som for eksempel vaser, som indeholder vand, på apparatet.
- Når knappen er i stilling OFF, er udstyret ikke helt frakoblet MAINS.

# CONTENTS

BEFORE USE .....	1
FEATURES .....	2
BEFORE MAKING CONNECTIONS .....	3
WIRING SPEAKER CABLE .....	3
BI-WIRING CONNECTION .....	3
COMPLETE BI-AMP CONNECTION .....	3
SPEAKER POSITIONING FOR SUPER AUDIO MULTI-CHANNEL SOUND .....	3
CONNECTIONS .....	5
NAMES AND FUNCTIONS OF PARTS .....	8
FRONT PANEL .....	8
DISPLAY .....	9
REAR PANEL .....	10
RC-11PMS1 REMOTE CONTROLLER .....	12
BASIC OPERATION .....	14
PLAYBACK .....	14
RECORDING .....	15
HOW TO USE AND SET FEATURES .....	16
ABOUT FCBS .....	16
FCBS CONNECTION WITH A PM-15S1 .....	16
ABOUT THE BI-AMP MODE .....	16
ATTENUATION (ATT) .....	17
HOW TO OPERATE THE SIDE ILLUMINATION .....	17
TRIMMING .....	18
HOW TO SET ID .....	19
REMOTE CONTROL JACKS .....	20
TROUBLESHOOTING .....	21
OTHERS .....	22
SPECIFICATIONS & DIMENSIONAL DRAWINGS .....	23

# BEFORE USE

This section must be read before any connection is made to the mains supply.

## ■ EQUIPMENT MAINS WORKING SETTING

Your Marantz product has been prepared to comply with the household power and safety requirements that exist in your area.

PM-15S1 can be powered by 230V AC only.

## ■ COPYRIGHT

Recording and playback of any material may require consent. For further information refer to the following:

- Copyright Act 1956
- Dramatic and Musical Performers Act 1958
- Performers Protection Acts 1963 and 1972
- Any subsequent statutory enactments and orders

## ■ Do Not Locate in the Following Places

To ensure long-lasting use, do not locate the PM-15S1 where:

- Exposed to direct sunlight.
- Near to sources of heat such as heaters.
- Highly humid or poorly ventilated.
- Dusty.
- Subjected to mechanical vibrations.
- On wobbly, inclined or otherwise unstable surfaces
- Radiated heat is blocked such as in cramped audio racks.

To ensure proper heat radiation, ensure the below clearance from walls and other equipment.

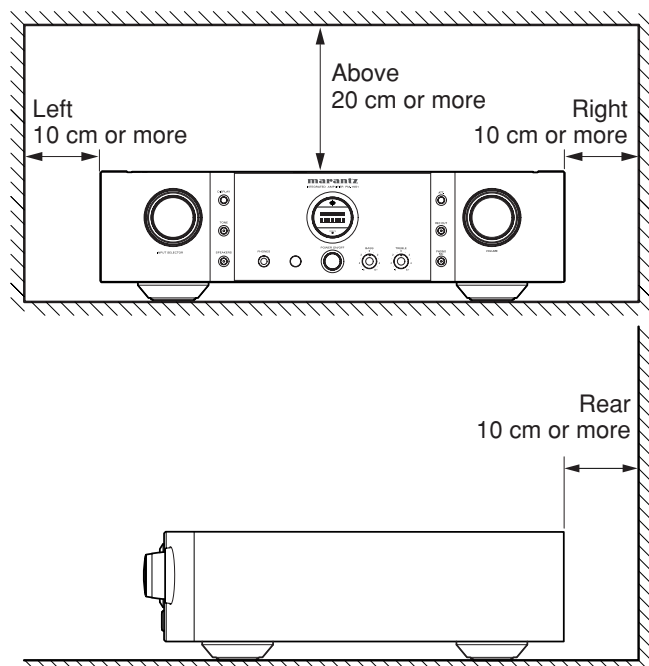

## ■ Keep Objects Off

Keep objects off the PM-15S1. Blocking the vent can result in accident and damage.

## ■ Do Not Touch Hot Spots During and Immediately After Use

During and immediately after use, the PM-15S1 is hot in areas other than the controls and rear panel connection jacks. Do not touch hot spots and especially the top panel. Contact with hot areas can cause burns.

## ■ Battery Handling

Improper use of dry cell batteries can result in electrolyte leaks, rupture and corrosion. Read the following precautions before use.

- If not planning to use the remote controller for an extended period of 1 month or more, remove the batteries.
- Do not mix old batteries with new batteries.
- Load batteries in the proper direction indicated on the remote controller.
- Do not mix batteries of differing type. Even batteries of the same shape and size can have differing voltages.
- If batteries leak, wipe the case clean of any adhering electrolyte and replace the old batteries with new batteries.

## ■ Accessories Check

Before use, check the below accessories were included in the package.

- AC power cable

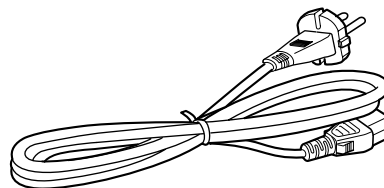

The power cable included in the package can be used with the PM-15S1 only. It cannot be used with other equipment.

- RC-11PMS1 remote controller
- AAA batteries x 2

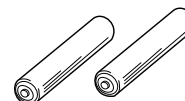
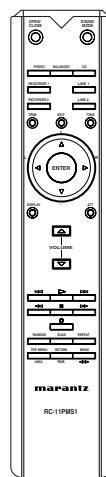

- Instruction Manual (This manual)

# FEATURES

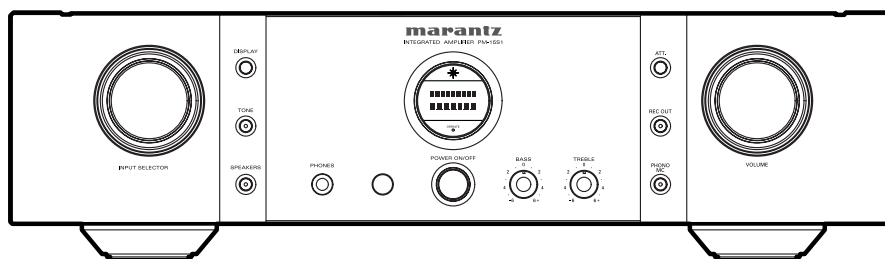

Marantz has surpassed itself with the new PM-15S1 stereo integrated amplifier, which incorporates many of the design concepts of the PM-11S1 flagship model amplifier.

## Amplifier

### • HDAM®SA2

As in the PM-11S1 model, the PM-15S1 also incorporates the HDAM®SA2 as the main amp module. The HDAM®SA2 includes an input buffer, linear control volume and power buffer.

### • Linear Control Volume

PM-15S1 inherits the Linear Control Volume system used in the PM-11S1, which offers smooth volume control of  $\pm 0.5$ dB steps in a range of 0dB - 100dB.

### • Current Feedback Phono Equalizer

The Phono Equalizer, which has MM/MC type cartridge support, also inherits the Current Feedback Phono Equalizer used in PM-11S1.

### • Input Buffer

The input buffer is composed of the HDAM®SA2 in the input section, which enables signals from the input source to be transmitted precisely to the linear control volume.

### • Power Amplifier

Following closely in the footsteps of its predecessor, the PM-11S1 is designed using a two-amplifier construction. By using a two-amplifier system, the power buffer uses high power to drive the speakers, therefore cutting the effects of Back EMF from the speakers.

## Power

### • Power Transformers

Newly developed Toroidal power transformers are used in the PM-15S1 because they produce less vibration and magnetic leak than ordinary laminate design transformers. Vibration reduction is achieved by using ring shaped core materials, while rigorous controls are maintained on the manufacturing process. Furthermore, the transformer periphery is covered with a ring core and short ring to reduce magnetic flux leak.

### • LC Ripple Filter

An LC Ripple Filter has been incorporated into the pre-amp power circuit, which provides "clean" power to the pre-amp section. "Clean" power is achieved by cutting out rectifier noise generated by the rectifier circuit, as well as external high frequency noise.

## Functions

### • Bi-Amp Mode

The complete bi-amp connection proposed by Marantz with the SC-7S1 and MA-9S1 reproduces a sound environment never before experienced. This same bi-amp connection has been made possible with the PM-15S1. Two PM-15S1s are connected by F.C.B.S. in a bi-amp mode that enables each to work as a monaural integrated amplifier.

### • Floating Control Bus System

A Floating Control Bus System (FCBS) enables the user to connect up to four PM-15S1s, making possible a diversity of applications with complete bi-amp and multiple channel connections. (pg. 6, 7) Moreover, a ground loop is not formed between multiple connected PM-15S1s, therefore sound quality is not adversely affected.

### • Display

The PM-15S1 adopts an LCD to display input source and volume level. Compared to other types of display panels, an LCD generates less drive noise and radiated noise, hence the effect on sound quality is minimal.

# BEFORE MAKING CONNECTIONS

## WIRING SPEAKER CABLE

- Be careful not to short circuit in wiring speaker cables.
- Peel off the coating of speaker cable as shown below.

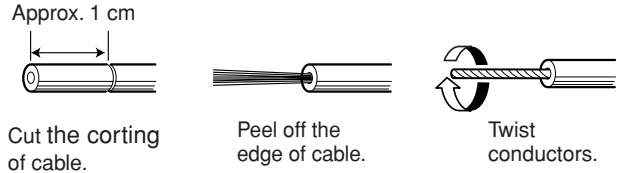

- Wiring with speaker cable.

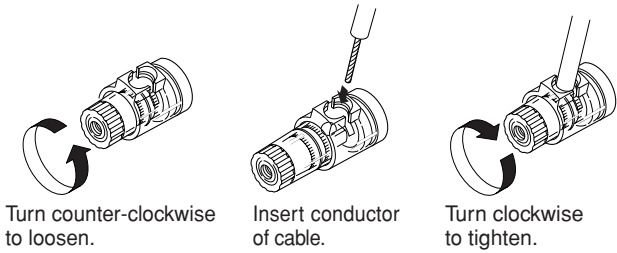

- Wiring with "Y" style terminal

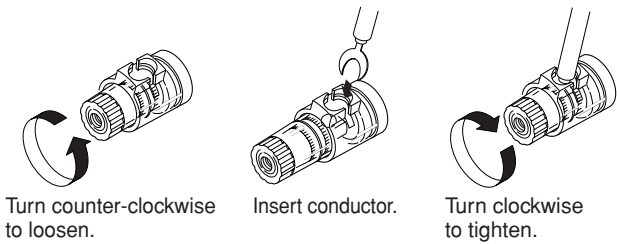

Your speaker system must satisfy the below conditions. If it does not, the PM-15S1's protective circuit will trip, whereby preventing proper playback. In some cases, the amplifier and speakers may be damaged.

- If using 1 set of speakers, total speaker impedance must be 4Ω or more.
- If using 2 sets of speakers, total speaker impedance must be 8Ω or more.

Here following are explained two types of connections that improve sound quality. The speakers in these explanations have low and mid/high input jacks that support a bi-amp connection. To determine whether or not your speakers support a bi-amp connection, check in the instruction manual that came with your speakers or contact the manufacturer.

## BI-WIRING CONNECTION

A bi-wiring connection separately connects the low and mid/high jacks of the speaker to the amplifier using separate speaker cables. Because separate cables are used for low and mid/high sounds, the return current generated in the low speaker causes little interference with the mid/high speaker. The PM-15S1 and speakers of Connection Example 1 (pg. 5) use a bi-wiring connection, therefore also refer to that page for help.

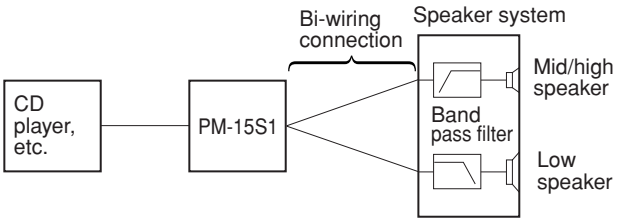

## COMPLETE BI-AMP CONNECTION

Proposed by Marantz, the complete bi-amp connection enhances the bi-wiring connection. With it, the low and mid/high amplifiers are separate and independent of the preamplifier, therefore interference between low and mid/high sounds is reduced to a minimum. As a result, a wide sound environment can be reproduced. Connection Example 3 (pg. 7) connects two PM-15S1s by FCBS in a complete bi-amp connection, therefore also refer to that page for help.

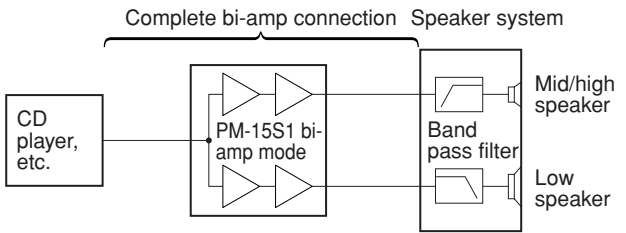



## BEFORE MAKING CONNECTIONS

### SPEAKER POSITIONING FOR SUPER AUDIO MULTI-CHANNEL SOUND

In order to enjoy Super Audio CD multi-channel sound with the best possible acoustics, it is recommended to position speakers as specified in ITU-R BS.775-1 of the International Telecommunication Union (ITU). Super Audio CD multi-channel discs are recorded and mixed so as to achieve the optimum effect with a speaker system laid out as specified in ITU-R BS.775-1.

- With Super Audio CD multi-channel discs, the music signals are basically recorded using 5 channels (3 - 6 channels sometimes), but in some cases, LFE (for subwoofer) is recorded as a sixth channel. Each disc indicates how many channels have been recorded on it.
- The basic layout is 3 speakers in the front and 2 in the back since multi-channel discs usually have 5 channels. The 2 front, 1 center and 2 surround (rear) speakers should be set in a circle around the listening point as shown below. If using speakers of differing sizes, adjust volume balance from the amplifier.
- The location of the subwoofer in the figure is just for explanatory purposes. It can be located anywhere in the room. For connection and positioning instructions, see the instruction manual that came with the subwoofer.

### ■ ITU (International Telecommunication Union)

The ITU is a special organization of the United Nations. It consists of a number of organs, one of which is the Radio Broadcasting Section.

ITU-R BS is the recommendation which consists of standards relating to broadcasting (audio) operations, one of which is the ITU-R BS.775-1 which governs "multi-channel stereo sound systems."

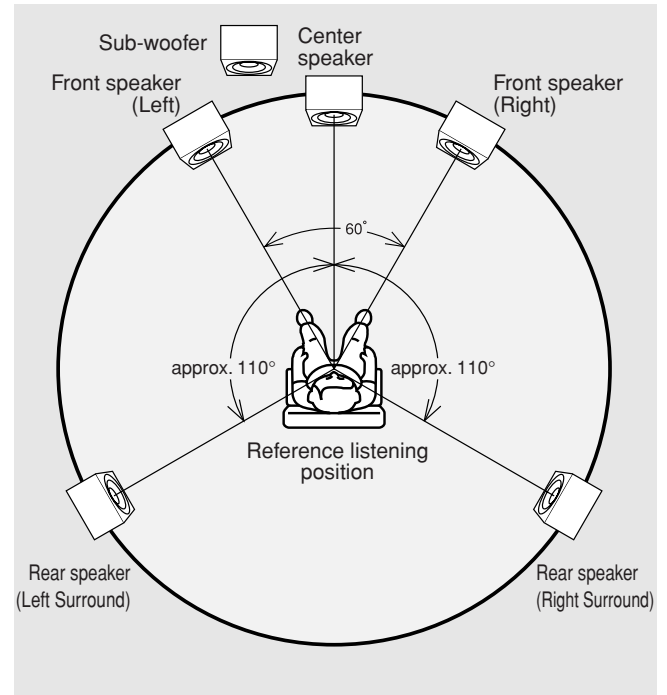

# CONNECTIONS

## Connection Example 1: Basic Connection for Normal Stereo Playback

Refer also to the instruction manuals of components to connect equipment correctly.

- Use a bi-wiring connection (pg. 3) for speakers.
- Set the SPEAKER button on the front panel in the ON position.
- To record, set the REC OUT button on the front panel in the ON position.

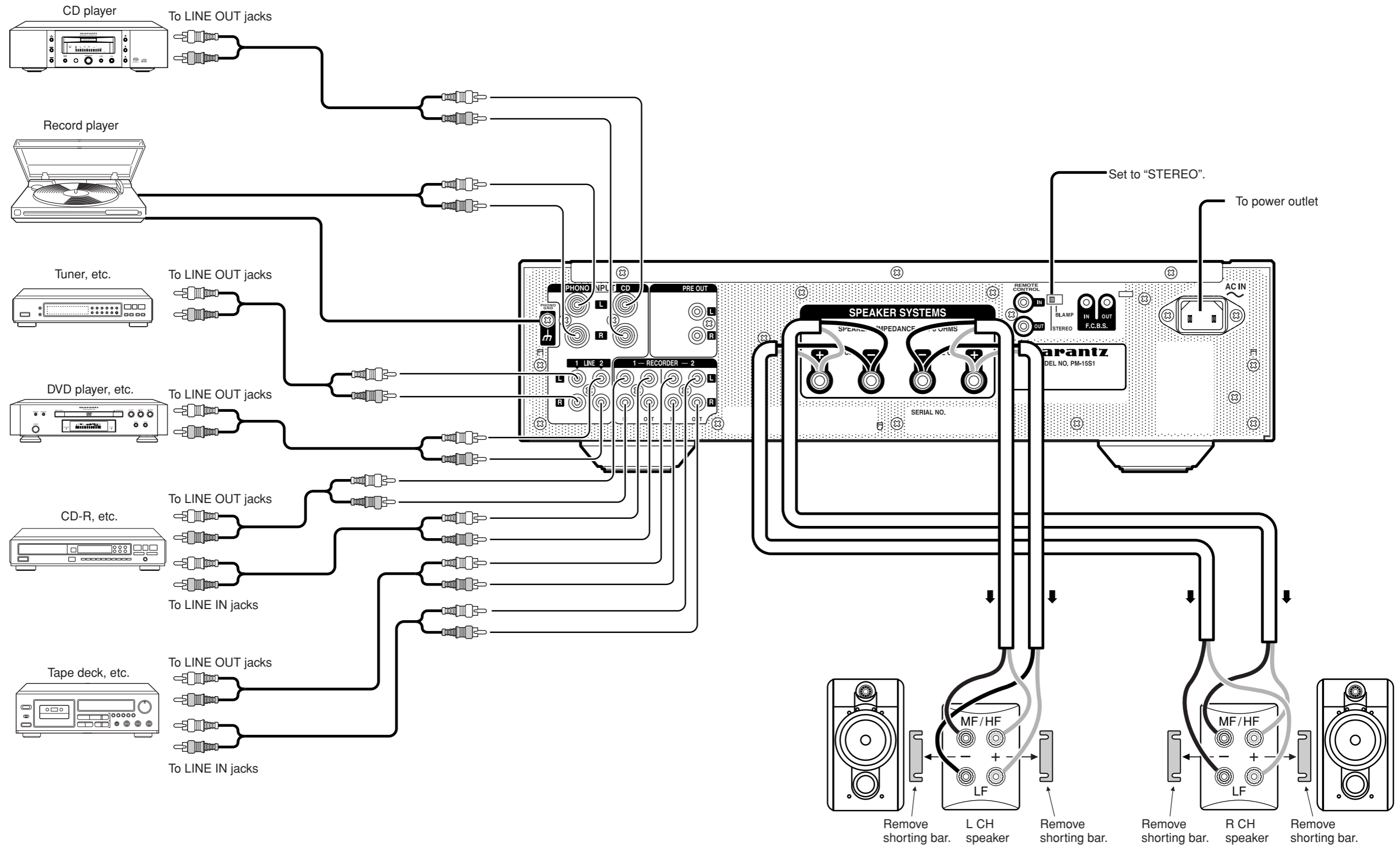

**Connection Example 2: Basic Connection for 5.1 Multi-Channel Playback Using 3 PM-15S1**

The three PM-15S1s are connected by FCBS. For the FCBS connection, prepare 3 portable audio connection cables with monaural ↔ monaural miniplugs or stereo ↔ stereo miniplugs as described “**ABOUT FCBS**” on pg. 16. Set the ID numbers for the PM-15S1 units as explained “**HOW TO SET ID**” on pg. 19. When the PM-15S1 of ID 1 is operated, those of ID 2 and ID 3 will operate in sync. If using an active subwoofer, see the instruction manual that came with the subwoofer for connection and positioning instructions.

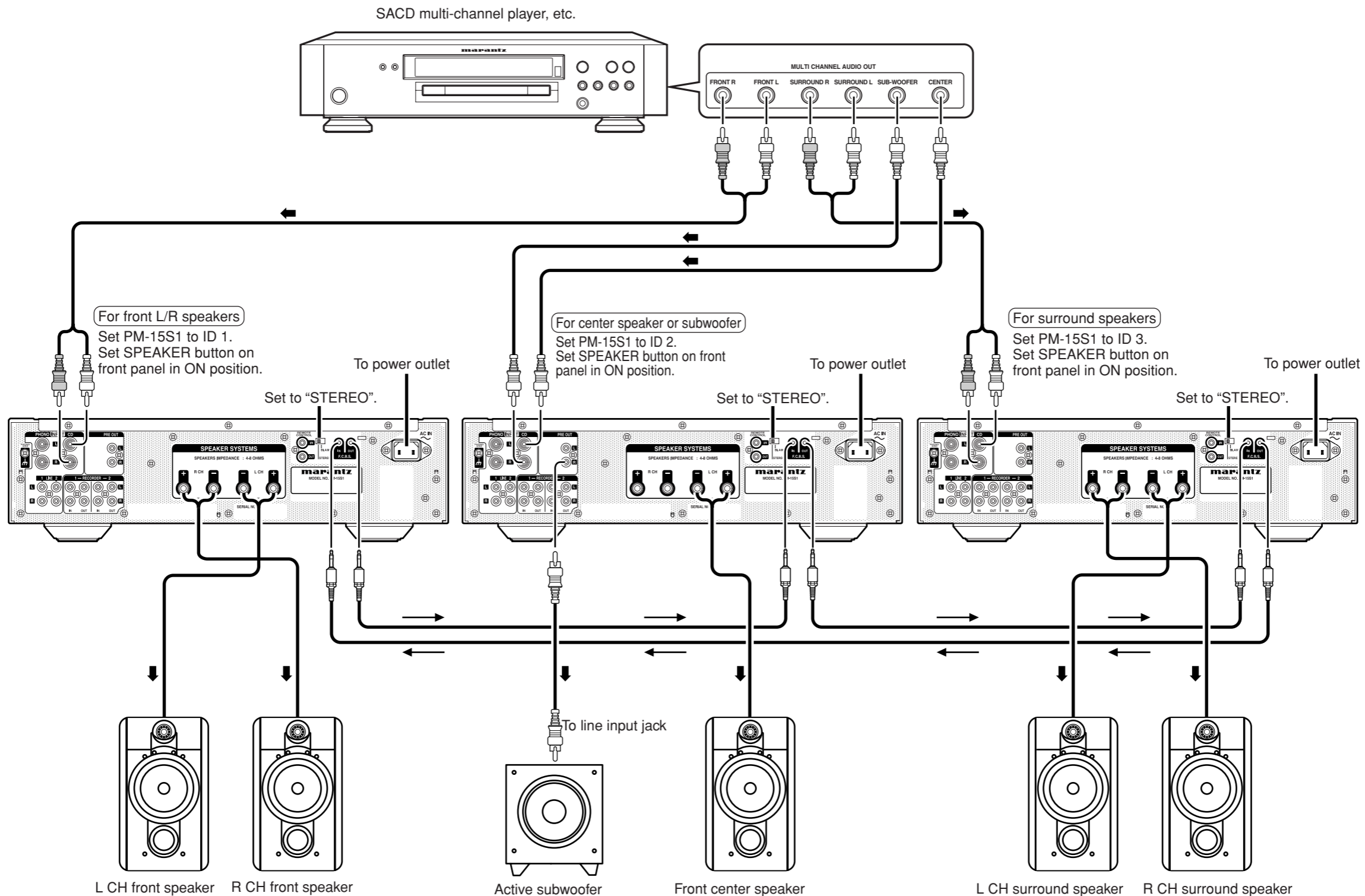

# CONNECTIONS

## Connection Example 3: Complete Bi-Amp Connection for Stereo Playback Using 2 PM-15S1

The speaker system must support a bi-amp connection, therefore to determine whether your speakers do or not, check in the instruction manual that came with your speakers or contact the manufacturer. The two PM-15S1s are connected by FCBS. For the FCBS connection, prepare 2 portable audio connection cables with monaural ↔ monaural miniplugs or stereo ↔ stereo miniplugs as described “ABOUT FCBS” on pg. 16. Set the ID numbers for the PM-15S1 units as explained “HOW TO SET ID” on pg. 19. When the PM-15S1 of ID 1 is operated, that of ID 2 will operate in sync.

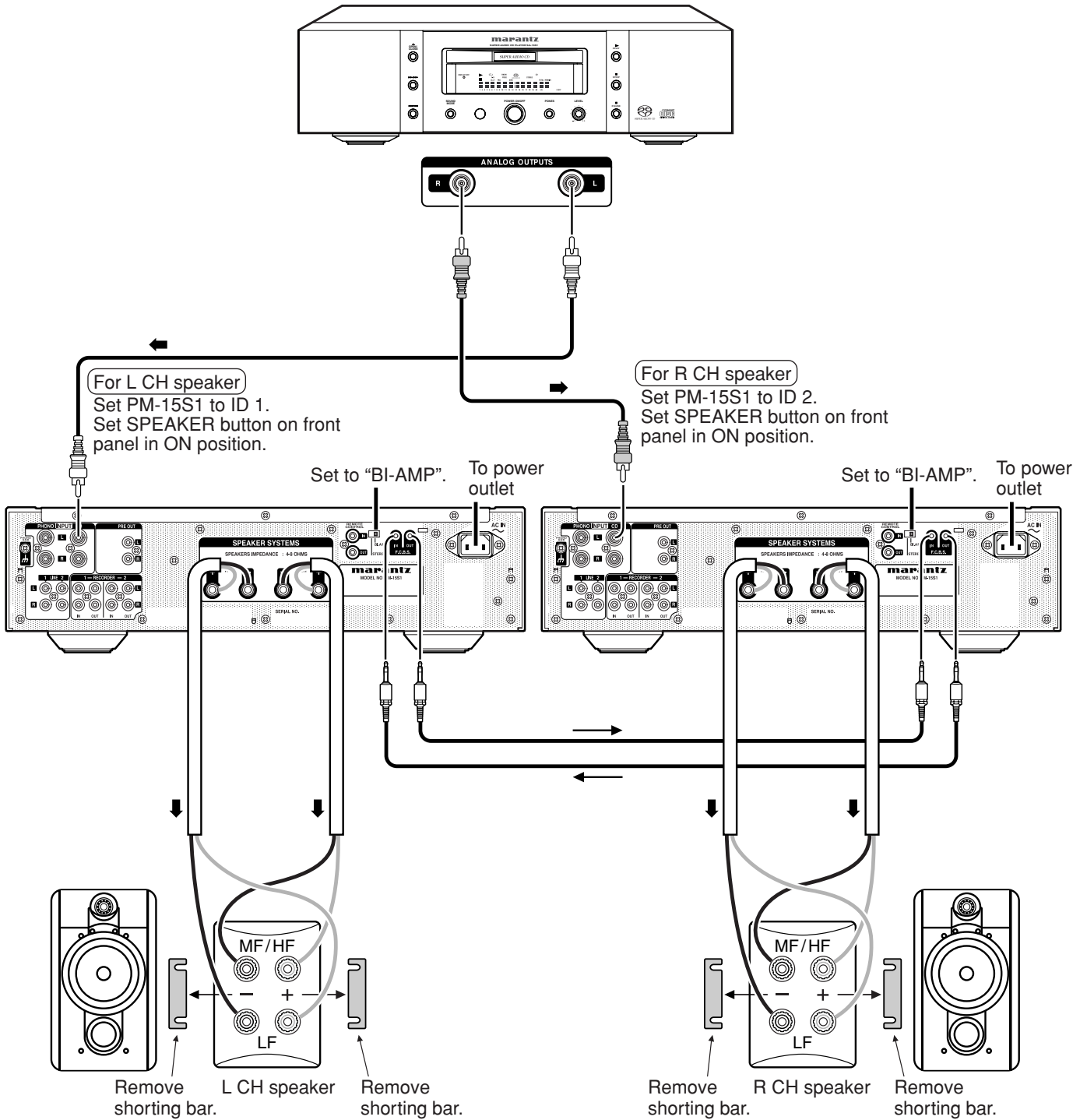

# NAMES AND FUNCTIONS OF PARTS

## FRONT PANEL

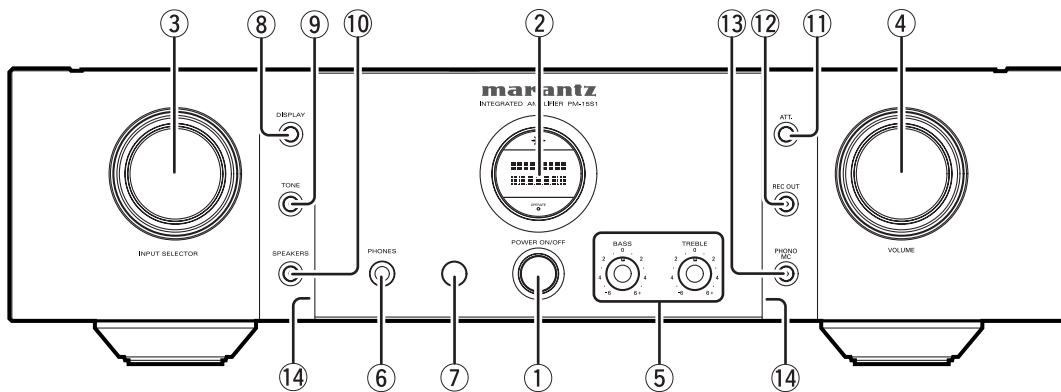

### ① POWER ON/OFF Switch

This switch turns power to the PM-15S1 ON and OFF. When pressed, power is activated and the blue indicator on the display ② lights up. Approximately 8 seconds after power is activated, audio output is enabled. Pressing the switch again turns power OFF.

### ② Display

The display displays the selected input source, volume level and setting status.

### ③ INPUT SELECTOR Knob

This knob is for selecting the input source to use in playback and recording. The selected input source is displayed on the display ②.

### ④ VOLUME Knob

This knob is for setting the volume. The volume level is displayed on the display ②. Turning the knob clockwise increases the volume, while turning it counterclockwise decreases the volume. When turned slowly, the volume can be fine-adjusted in 0.5 dB steps, whereas when turned rapidly, volume level changes greatly.

### ⑤ BASS/TREBLE Knobs

These buttons adjust the bass and treble. Turning them clockwise increases the respective tone, whereas turning them counterclockwise decreases the respective tone. Tone cannot be adjusted while the TONE button ⑨ is in the OFF position, therefore set the button in the ON position to control bass and treble from these buttons.

### ⑥ PHONES Jack

This jack is for connecting headphones with a standard stereo plug. To listen with headphones, turn speaker output OFF by setting the SPEAKERS button ⑩ in the OFF position.

### ⑦ Infrared Receptor Window

This is the receptor of control signals sent from the included RC-11PMS1 remote controller. Point the remote controller towards this window to properly send signals.

### ⑧ DISPLAY Button

This button turns the display and illumination lamp ON and OFF.

If the display is out and the VOLUME knob or other control is operated, the display lights up. It will automatically go out 3 seconds after the operation has been completed.

### ⑨ TONE Button

This button turns the bass and treble tone control ON and OFF. When tone control is ON, the center of the button is lit a blue color.

### ⑩ SPEAKERS Button

This button turns output to the speakers connected to the SPEAKER SYSTEMS output terminals on the rear panel ON and OFF. When speaker output is ON, the center of the button is lit a blue color. To listen with headphones, turn speaker output OFF.

### ⑪ ATT. Button

This button attenuates volume with one press of the button. When pressed, "ATT" flashes on the display and the volume is reduced. If pressed again, the mode is canceled and the original volume level is restored. Attenuation level is set to -20 dB when the PM-15S1 is shipped from the factory, but it can be set to either -40 dB or  $-\infty$  (mute). For instructions on how to set attenuation level, see "ATTENUATION (ATT)" on pg. 17.

# NAMES AND FUNCTIONS OF PARTS

## 12 REC OUT Button

This button turns the signals output from the RECORDER 1 and 2 OUT jacks on the rear panel ON and OFF. When output is ON, the center of the button is lit a blue color. For instructions on how to record, see “**RECORDING**” on pg. 15.

When RECORDER 1 is selected as the input source, signals are not output to the RECORDER 1 OUT jack. The same goes for the RECORDER 2 OUT jack when RECORDER 2 is selected as the input source.

## 13 PHONO MC Button

This button switches the phono equalizer between MC and MM. When MC is set, the center of the button is lit a blue color. Set the phono equalizer amplifier according to the type of cartridge you use.

## 14 Illumination Lamp

The side illumination casts a blue light over switches and buttons. It can be turned ON and OFF from the DISPLAY button. For instructions on how to operate the side illumination, see “**HOW TO OPERATE THE ILLUMINATION LAMP**” on pg. 17.

# DISPLAY

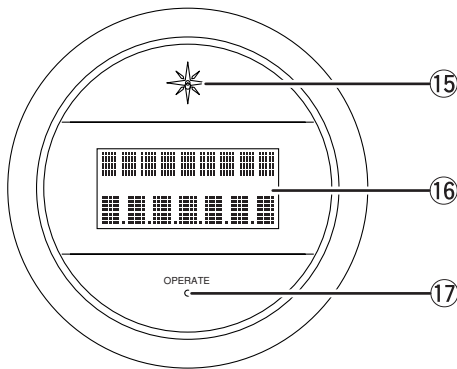

## 15 Power Indicator

This indicator is lit a blue color while power to the PM-15S1 is ON.

## 16 Display Panel

Approximately 3 seconds after power to the PM-15S1 is activated, the ID set for the PM-15S1 is displayed here.



After that, the top line displays the input source, while the bottom line displays the volume level. The volume level is displayed as an attenuation level (dB).

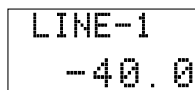

## Volume Level Indication

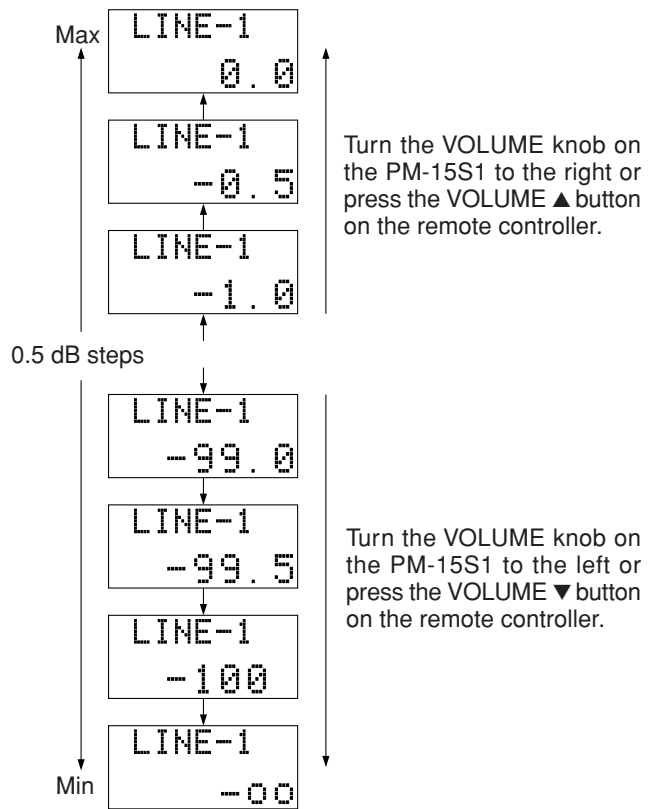

The display panel also displays left-right volume level balance. For instructions on how to trim volume level, see “**TRIMMING**” on pg. 18.

The display panel also displays messages in response to PM-15S1 operation.

## 17 OPERATE Indicator

This indicator indicates the operating status of the PM-15S1. When the ID is set to “0” for standalone operation, it is lit a red color. When multiple PM-15S1s are connected by FCBS, only the OPERATE indicator of the master PM-15S1 (ID 1) lights a red color. Slave PM-15S1s whose OPERATE indicator does not light a red color cannot be used to operate other units in sync. For more information on the FCBS, see “**ABOUT FCBS**” on pg. 16.

## NAMES AND FUNCTIONS OF PARTS

### REAR PANEL

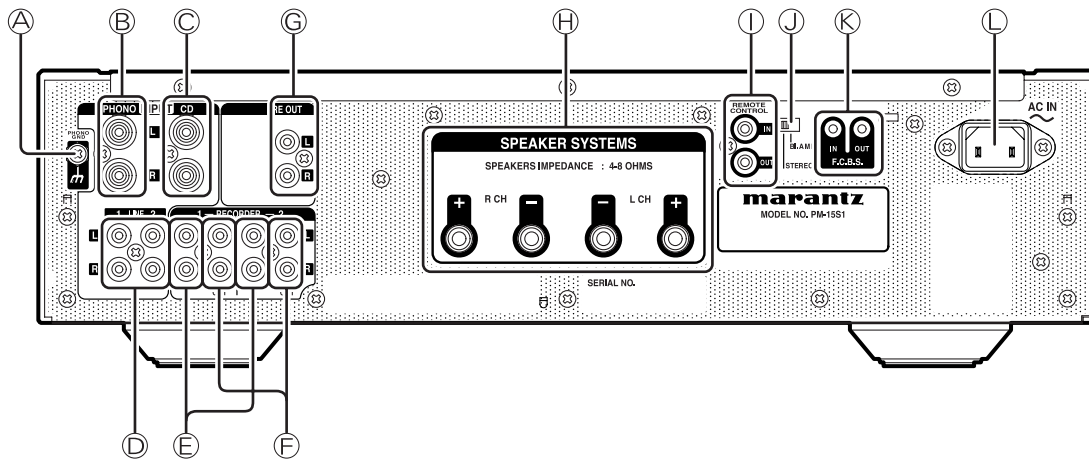

#### Ⓐ PHONO GND Terminal

Connect the grounding wire from an analog record player here.

#### Ⓑ PHONO Input Jacks

These jacks are for connecting to an analog record player. Both MC and MM cartridges can be used, therefore set the PHONO MC button on the front panel according to the type of cartridge you are using.

In the bi-amp mode, the R channel jack cannot be used.

#### Ⓒ CD Input Jacks

These jacks are for connecting to the output jacks of a Super Audio CD player, CD player, etc.

In the bi-amp mode, the R channel jack cannot be used.

#### Ⓓ LINE 1/2 Input Jacks

These jacks are for connecting to the output jacks of a tuner, DVD player, etc.

In the bi-amp mode, the R channel jack cannot be used.

#### Ⓔ RECORDER 1/2 IN Jacks

These jacks are for connecting to the output jacks of a CD-R, MD deck, tape deck, etc.

In the bi-amp mode, the R channel jack cannot be used.

#### Ⓕ RECORDER 1/2 OUT Jacks

These jacks are for connecting to the recording input jacks of a CD-R, MD deck, tape deck, etc. Output signals can be turned ON/OFF from the REC OUT button on the front panel.

#### Ⓖ PRE OUT Jacks

These jacks are for connecting to the input jacks of another main amplifier or active subwoofer. Output signals can be turned ON/OFF from the PRE OUT button on the front panel.

In the bi-amp mode, the signals input to the L channel are output to both output jacks.

#### Ⓗ SPEAKER SYSTEMS Output Terminals

These terminals are for connecting a speaker system. Speaker output can be turned ON/OFF from the SPEAKERS button on the front panel.

In the bi-amp mode, the signals input to the L channel are output to both output terminals.

#### Ⓙ REMOTE CONTROL Jacks

These jacks are for connecting components that are capable of remote control (D.BUS jacks) such as a Marantz Super Audio CD Player or DVD Player. This enables these other components to be operated with the remote controller included with the PM-15S1.

See “REMOTE CONTROL JACKS” on pg. 20.

## NAMES AND FUNCTIONS OF PARTS

### Ⓜ **Operating Mode Switch**

This switch is for setting the operating mode of the PM-15S1.

**STEREO:** Set to use the PM-15S1 as an ordinary 2-channel stereo amplifier.

**BI-AMP:** Set to use two PM-15S1s in a complete bi-amp connection with FCBS. For more information on the bi-amp mode, see “**ABOUT THE BI-AMP MODE**” on pg. 16.

### Ⓚ **F.C.B.S. IN/OUT Jacks**

You can connect and synchronize up to four PM-15S1s in a complete bi-amp connection or multi-channel connection. A stereo miniplug or monaural miniplug cable can be used for the connections. For instructions on use and connections, see “**ABOUT FCBS**” on pg. 16.

### Ⓛ **AC IN Socket**

Connect one end of the included power cable here and the other end to a power outlet. The PM-15S1 can be powered by 230V AC only.



## NAMES AND FUNCTIONS OF PARTS

### RC-11PMS1 REMOTE CONTROLLER

This remote controller can control the PM-15S1 and Marantz Super Audio CD players and DVD players that have a remote control receptor. The operations possible by remote control may differ with each component, therefore see the instruction manual that came with the component.

Remote controller buttons are laid out as shown below.

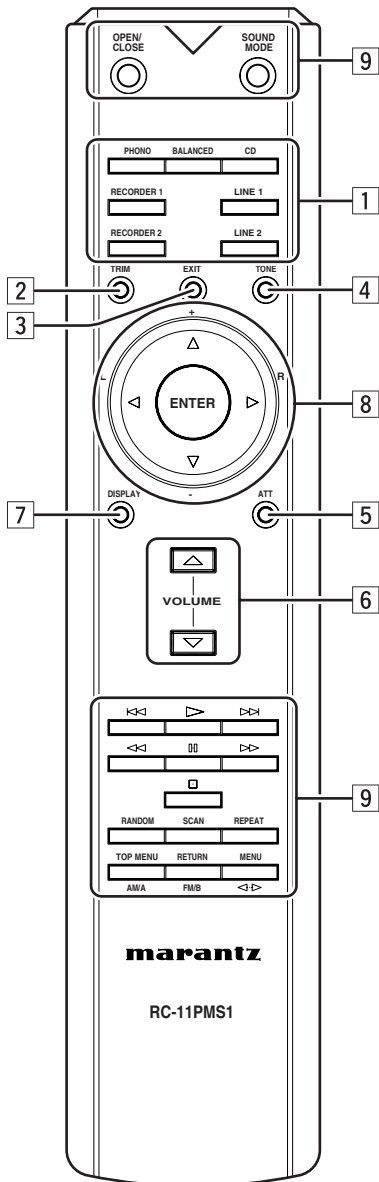

#### 1 Input Selector Buttons

These buttons are for selecting the input source to use in playback.

The PM-15S1 does not support balanced input, therefore the BALANCED button does not respond even if pressed.

#### 2 TRIM Button

This button starts trimming. When multiple PM-15S1s are connected by FCBS, this button selects the amplifier with which to perform trimming.

#### 3 EXIT Button

This button ends the trimming mode when trimming is finished.

#### 4 TONE Button

This button turns tone (bass /treble) control ON and OFF.

#### 5 ATT Button

This button attenuates volume level with one press.

#### 6 Volume Buttons

- ▲ : This button increases the volume level.
- ▼ : This button decreases the volume level.

#### 7 DISPLAY Button

This button turns the display ON and OFF.

#### 8 Cursor Buttons

##### In the Trimming Mode

These buttons are for selecting the channel to trim and the trimming level.

ENTER: Not available for use.

- ▶/R : This button selects the R channel for trimming.
- ◀/L : This button selects the L channel for trimming.
- ▲/+ : This button increases the trimming level.
- ▼/- : This button decreases the trimming level.

##### Other than the Trimming Mode

▶, ◀, ▲, ▼ and ENTER: These buttons are for selecting settings items on menu displays of Marantz DVD players, etc. For operations of supported Marantz products, see the tables on the following page and the instruction manual of the Marantz component.

#### 9 Component Operating Buttons

These buttons are for operating Marantz Super Audio CD players, DVD players, etc. For operations of supported Marantz products, see the tables on the following page and the instruction manual of the Marantz component.

# NAMES AND FUNCTIONS OF PARTS

The buttons in groups [8] and [9] are for operating Marantz products other than the PM-15S1, such as Super Audio CD players and DVD players. The function of each button changes to match the component selected as the input source from the input selector buttons [1].

When the CD button is pressed, the buttons in groups [8] and [9] function as indicated in the table below. These buttons can be used only when a Marantz Super Audio CD player is connected to the CD input jacks.

Button	Function
OPEN/CLOSE	Open/Closes disc tray.
SOUND MODE	Selects Super Audio CD sound mode. Selects Super Audio CD/CD.
▶	Play
⏮	Track skip (Returns to track beginning/previous track.)
⏭	Track skip (Advances to next track.)
⏪	Rewind search
⏩	Forward search
⏸	Pause
■	Stop
RANDAM	Random play
SCAN	AMS (Automatic Music Scan) play
REPEAT	Repeat play
TOP MENU/AM/A	Not available for use
RETURN/FM/B	Not available for use
MENU ◀▶	Sets quick replay.
ENTER	Starts quick replay.
▲ / +	Not available for use
▼ / -	Not available for use
◀ / L	Not available for use
▶ / R	Not available for use

When the LINE 2 button is pressed, the buttons in groups [8] and [9] function as indicated in the below table. These buttons can be used only when a Marantz DVD player is connected to the LINE 2 input jacks.

Button	Function
OPEN/CLOSE	Open/Closes disc tray.
SOUND MODE	Changes sound mode.
▶	Play
⏮	Track skip (Returns to track beginning/previous track.)
⏭	Track skip (Advances to next track.)
⏪	Rewind search
⏩	Forward search
⏸	Pause
■	Stop
RANDAM	Random play
SCAN	Selects search mode.
REPEAT	Repeat play
TOP MENU/AM/A	Displays top menu.
RETURN/FM/B	Returns to previous menu
MENU ◀▶	Displays menu screen.
ENTER	Sets selected item.
▲ / +	Moves cursor upward.
▼ / -	Moves cursor downward.
◀ / L	Moves cursor to left.
▶ / R	Moves cursor to right.

## ■ For use of Remote controller

### • Loading batteries

Before using the supplied remote control unit for the first time, load the batteries in the remote control unit. The batteries provided are used to verify the operations of the remote control unit only.

1. Remove the battery cover which is found on the back side of the remote control unit.

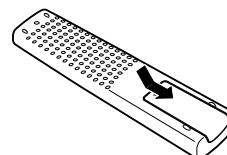

2. Load the two new size "AAA" batteries inside the battery compartment while taking care to align their polarities correctly with the polarity markings (+ with + and - with -).

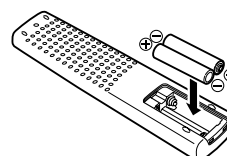

3. Push the cover on the back side in the direction of the arrow to close.

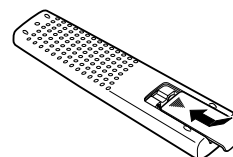

### ■ Operable range of Remote controller

Operate the remote control unit (RC-11PMS1) within a distance of approx. 5 m from the infrared signal reception window (remote sensor) on the front of the PM-15S1.

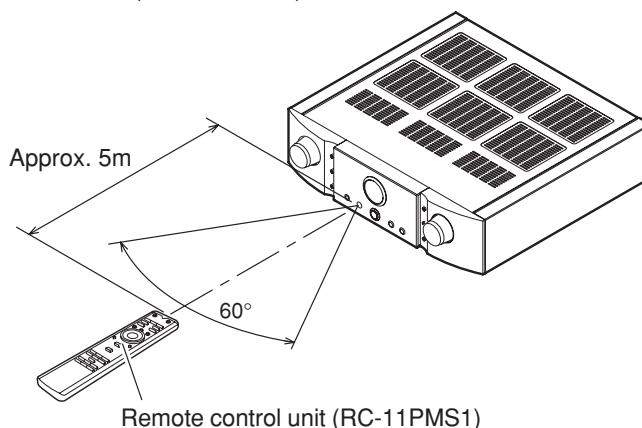

### • Caution

- Do not allow direct sunlight, an inverter fluorescent light or other strong source of light to shine onto the player's infrared signal reception window (remote sensor). Otherwise, the operation of the remote control unit may be disabled.
- Bear in mind that operating the remote control unit may cause other devices operated by infrared rays to be operated by mistake.
- The remote control unit cannot be operated if the space between the controller and the player's remote sensor is obstructed.
- Do not place any objects on top of the remote control unit. Doing so may cause one or more buttons to be held down which will cause the batteries to run down.

# BASIC OPERATION

## PLAYBACK

To explain how to play back input sources, representative examples are given with an Super Audio CD player and analog record player. Before starting either procedure, check the component is correctly connected to the PM-15S1.

### ■ Disc Playback on an Super Audio CD Player

1. Press the power ON/OFF switch of the Super Audio CD player to activate power to it.
2. Press the POWER ON/OFF switch ① of the PM-15S1 to activate power to it. Approximately 8 seconds after power has been activated, the muting turns OFF and audio output is enabled. When using multiple PM-15S1s connected by FCBS, turn power ON in the order of lowest to highest ID number, starting from ID 1.
3. Select the input source from the INPUT SELECTOR knob ③ on the PM-15S1 or the input selector buttons ① of the remote controller.
4. To use the speakers connected to the SPEAKER SYSTEMS terminals, press the SPEAKERS button ⑩ on the PM-15S1.
5. Load a disc into the Super Audio CD player and press the play button to start playback.
6. Adjust the volume level from the VOLUME knob ④ on the PM-15S1 or the VOLUME ▲/▼ buttons ⑥ of the remote controller.
7. Adjust bass/treble as desired from the BASS and TREBLE knobs ⑤. Be sure to first set the TONE button ⑨ on the PM-15S1 or the TONE button ④ on the remote controller in the ON position.
8. You can turn the display and side illumination ON/OFF as suited for the room environment. Press the DISPLAY button ⑧ on the PM-15S1 or the DISPLAY button ⑦ of the remote controller.

### ■ Disc Playback on an Analog Record Player

1. Press the POWER ON/OFF switch ① of the PM-15S1 to activate power to it. Approximately 8 seconds after power has been activated, the muting turns OFF and audio output is enabled. When using multiple PM-15S1s connected by FCBS, turn power ON in the order of lowest to highest ID number, starting from ID 1.
2. Select "PHONO" as the input source from the INPUT SELECTOR knob ③ on the PM-15S1 or the input selector buttons ① of the remote controller. To prevent unexpected accidents, it is recommended to set the volume level to ∞ (mute) by turning the VOLUME knob ④ until muting the volume level.
3. Set the PHONO MC button ⑬ on the PM-15S1 to MC or MM according to the cartridge you are using.
4. To use the speakers connected to the SPEAKER SYSTEMS terminals, press the SPEAKERS button ⑩ on the PM-15S1.

5. Set a record on the analog record player and play it.
6. Adjust the volume level from the VOLUME knob ④ on the PM-15S1 or the VOLUME ▲/▼ buttons ⑥ of the remote controller.
7. Adjust bass/treble as desired from the BASS and TREBLE knobs ⑤. Be sure to first set the TONE button ⑨ on the PM-15S1 or the TONE button ④ on the remote controller in the ON position.
8. You can turn the display and side illumination ON/OFF as suited for the room environment. Press the DISPLAY button ⑧ on the PM-15S1 or the DISPLAY button ⑦ of the remote controller.

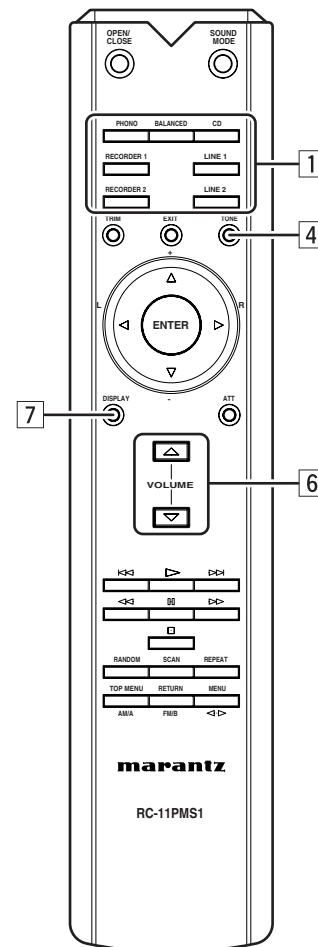
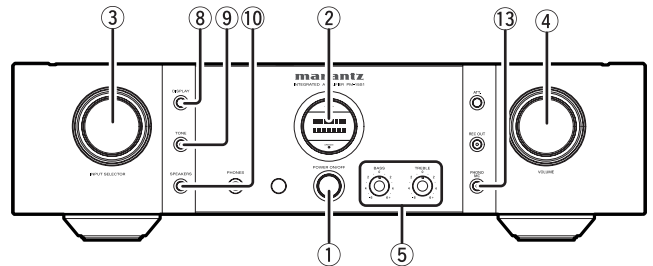

# BASIC OPERATION

## RECORDING

This example explains how to record from an input source such as a Super Audio CD player to a recording device such as a CD-R.

1. Press the power ON/OFF switch of the Super Audio CD player and CD-R to activate power to both components.
2. Press the POWER ON/OFF switch ① of the PM-15S1 to activate power to it. Approximately 8 seconds after power has been activated, the muting turns OFF and audio output is enabled. When using multiple PM-15S1s connected by FCBS, turn power ON in the order of lowest to highest ID number, starting from ID 1.
3. Select the input source from the INPUT SELECTOR knob ③ on the PM-15S1 or the input selector buttons ① of the remote controller. And, press the REC OUT button ⑫ to turn the recording output of RECORDER 1 and 2 ON.
4. Load a playback disc into the Super Audio CD player and a recording disc into the CD-R.
5. Start playback on the Super Audio CD player. Then, start recording on the CD-R.
6. To use the speakers connected to the SPEAKER SYSTEMS terminals, press the SPEAKERS button ⑩ on the PM-15S1.
7. Adjust the volume level from the VOLUME knob ④ on the PM-15S1 or the VOLUME ▲/▼ buttons ⑥ of the remote controller.

**Note**

When RECORDER 1 is selected as the input source, signals are not output to the RECORDER 1 OUT jack. The same goes for the RECORDER 2 OUT jack when RECORDER 2 is selected as the input source.

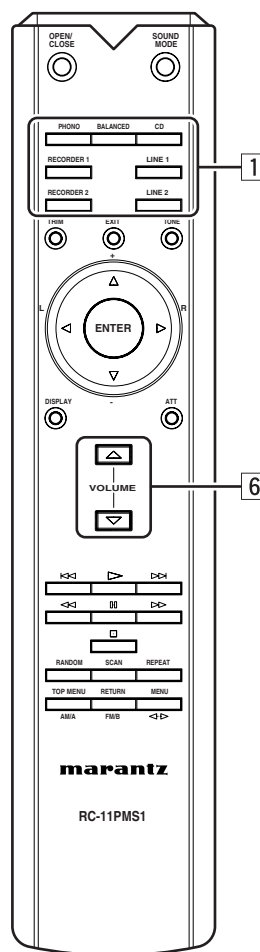
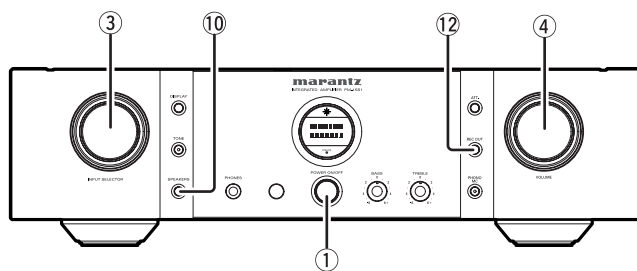

# HOW TO USE AND SET FEATURES

## ABOUT FCBS

FCBS is short for Floating Control Bus System. It is a communication system that connects up to four PM-15S1s over a dedicated bus line so as to enable synchronized operations amongst them via 2-way data communications.

The FCBS connections can be made with either of the below two types of portable audio connection cable. Prepare the number of connection cables for the number of PM-15S1s to connect.

- Connection cable with monaural  $\leftrightarrow$  monaural miniplugs
- Connection cable with stereo  $\leftrightarrow$  stereo miniplugs

**Resistor connection cables are sold commercially, but they cannot be used with the PM-15S1.**

The below figure is an example of four PM-15S1s connected by FCBS. The top PM-15S1 is the master unit of ID 1 and controls the three slave units of IDs 2 - 4. When the master PM-15S1 is operated, the input source, volume level, ATT feature, display and tone control ON/OFF feature of slave PM-15S1s are interlocked to the master unit.

This function can be applied to various usages such as complete-bi-amp with 2 PM-15S1s, and 5.1ch multi-channel with 3 PM-15S1s.

**To turn power to multiple FCBS-connected PM-15S1s ON/OFF, activate power in the order of lowest to highest ID number and deactivate power in order of highest to lowest ID number.**

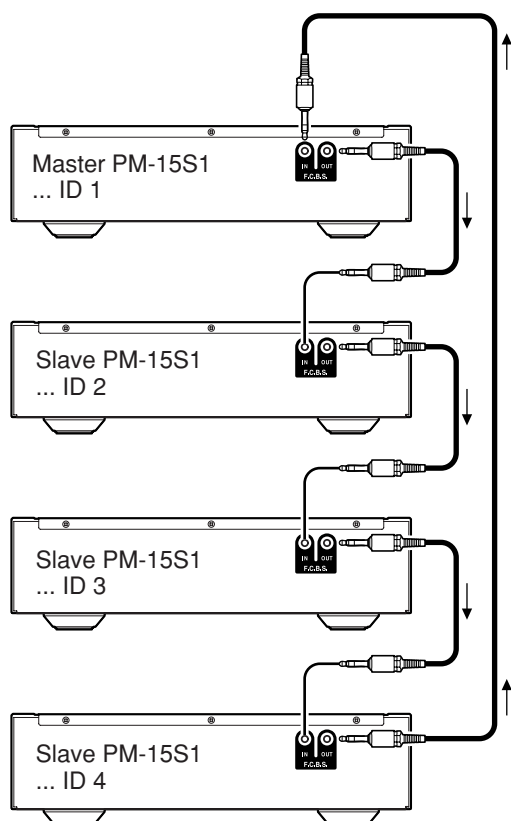

## FCBS CONNECTION WITH A PM-11S1

The PM-15S1 can be made into a multiple channel system by connecting to the high end PM-11S1 over a FCBS connection. However, because the PM-11S1 is more sophisticated than the PM-15S1, observe the following conditions in completing the FCBS connection between a PM-15S1 and a PM-11S1.

- Only one PM-11S1 may be used, whereas up to a maximum of three PM-15S1s can be connected.
- The one PM-11S1 must be the master unit of ID 1, while the PM-15S1s must be slave units with an ID of 2 to 4.

For a connection example, see Connection Example 2 on pg. 6. In that example, the PM-15S1 used for the front left and right channels is replaced with a PM-11S1, so improved sound quality can be expected from the front channels. (See also the instruction manual of the PM-11S1.) That same example is for a 5.1 channel system, but to use the system as a 2-channel stereo, turn OFF power to the PM-15S1s of IDs 2 and 3. As such, the PM-11S1 can be used on its own.

## ABOUT THE BI-AMP MODE

The PM-15S1 is equipped with a bi-amp mode to enable a complete bi-amp connection using two PM-15S1s. This complete bi-amp connection is a high-end technique for enhancing sound quality, proposed by Marantz. With it, the bi-amp supporting speaker system is separated from the preamplifiers that separately drive the low and high speakers. (For more information, see Connection Example 3 on pg. 7.)



The bi-amp mode is engaged by setting the operating mode switch on the rear panel to "BI-AMP".

In the bi-amp mode, the signals input to the L channel are passed through the input buffer amplifier, split by the input selector and transferred to the left and right volume amplifiers. After that, the signals are sequentially sent to the left and right voltage amplifiers and the left and right power amplifiers, and ultimately output to the speaker output terminals.

The below figure shows example displays in the stereo and bi-map modes.

Stereo mode

```
LINE-1
-40.0
```

Bi-amp mode

```
LINE-1
* -40.0
```

### Note

- In the bi-amp mode, the R channel input jacks cannot be used.
- Turn power to the PM-15S1 OFF before changing the operating mode switch setting. Turning the power ON again activates the new setting.

# HOW TO USE AND SET FEATURES

## ATTENUATION (ATT.)

Attenuation is a one-touch feature for reducing volume level. When the ATT button on either the PM-15S1 or the remote controller is pressed, the volume level is attenuated. When the PM-15S1 is shipped from the factory, the attenuation level is set to -20 dB, but it can be set to -20 dB, -40 dB or -∞.

1. When the ATT button on either the PM-15S1 or the remote controller is pressed, "ATT" flashes on the display and the volume level is reduced. When the ATT button is pressed again or the volume is increased/decreased from the controls, the mode is canceled and the original volume level is restored.



2. When the volume level is at -∞ (muted) and the ATT button is pressed, the below display appears for about 3 seconds and attenuation is not applied.



### How to Set Attenuation Level

Attenuation level cannot be set from the remote controller.

1. Press and hold the ATT button on the PM-15S1 for 2 seconds or longer. The attenuation level will appear on the display.

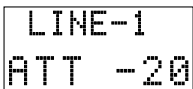

2. Set the attenuation level. The setting changes with each press of the ATT button on the PM-15S1.

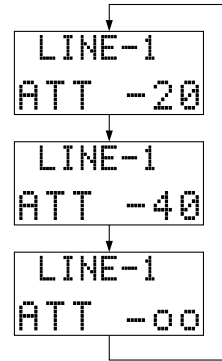

3. When the desired attenuation level setting appears on the display, leave it unchanged for approximately 2 seconds or longer to enter the setting. Once entered, the display returns to the volume level indication.

## HOW TO OPERATE THE SIDE ILLUMINATION LAMP

The illumination lamp has an always-ON mode and an always-OFF mode. In the always-ON mode, the illumination lamp turns ON/OFF in sync with the display.

1. With the illumination lamp lit, press and hold the DISPLAY button for 3 seconds or longer. The illumination lamp goes out and the always-OFF mode is engaged.
2. To cancel the always-OFF mode and turn the illumination lamp ON, press and hold the DISPLAY button for 3 seconds or longer.

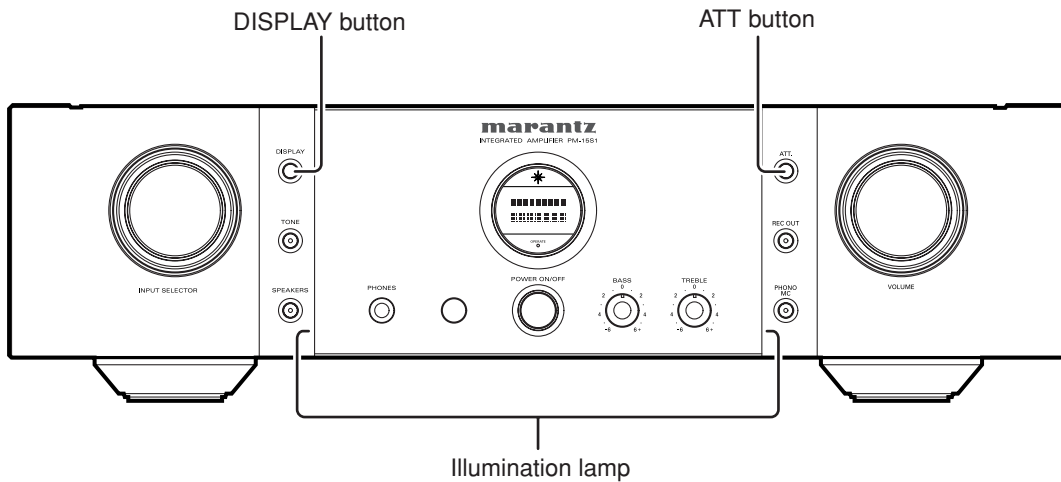

## HOW TO USE AND SET FEATURES

### TRIMMING

Trimming is a feature for adjusting left and right volume balance.

Trimming is performed from the remote controller.

**TRIM** : This button starts trimming. When multiple PM-15S1s are connected, this button selects the amplifier with which to perform trimming. In such case, trimming is performed in the order of the lowest to highest ID number.

**EXIT** : This button ends trimming.

▲ : This button increases the trimming level.

▼ : This button decreases the trimming level.

▶ : This button selects the R channel for trimming.

◀ : This button selects the L channel for trimming.

**ENTER**: Not available for use.

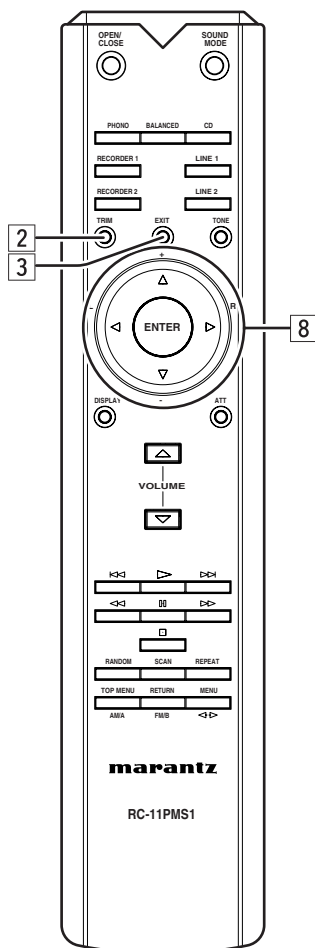

The volume level of the left and right channels can be trimmed in 0.5 dB steps across a 0.0 –9.0 dB range. When the PM-15S1 is shipped from the factory, the volume level is set to 0.0 dB (maximum).

1. Press the TRIM button once to access the LEVEL trimming mode.

```
L LEVEL R
 00  00
```

2. The flashing "0.0" on the left indicates that trimming is activated for the left channel volume level. Press the ▲ and ▼ buttons to set the volume level of the left channel.

```
L LEVEL R
-6.0  0.0
```

3. Press the ▶ button to set the right channel volume level. When the right side "0.0" starts flashing, trimming is activated for the right channel volume level. Press the ▲ and ▼ buttons to set the volume level of the right channel.

```
L LEVEL R
-6.0 -6.0
```

4. To trim the volume level of the ID 2 (slave) PM-15S1, press the TRIM button again and set volume level as in steps 1 - 3. After that, pressing the TRIM button again allows you to trim volume level with ID 3 (slave) PM-15S1 and so forth.
5. When finished with volume level trimming, press the EXIT button.

# HOW TO USE AND SET FEATURES

## HOW TO SET ID

If using the PM-15S1 by itself as a stereo amplifier, set the ID to "0". When the PM-15S1 is shipped from the factory, the ID is set to "0".

**When the ID is set to a number other than "0", the PM-15S1 cannot be used for standalone operation.**

The ID number of the PM-15S1 appears on the display for about 3 seconds after power is activated.



When multiple PM-15S1s are connected, a unique ID number must be set for each one in order to distinguish between them. The PM-15S1 that centrally controls the other PM-15S1s takes ID 1. The PM-15S1 with ID 1 is called the "master". The other PM-15S1s that synchronize with the master are called "slaves" and take IDs "2" - "4". ID numbers must not be the same for any two units.

Set ID numbers as follows.

1. While pressing and holding the DISPLAY button, press the POWER ON/OFF button.

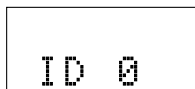

2. Turn the INPUT SELECTOR knob to the desired ID number.

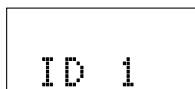

When finished setting the ID number, turn power to the PM-15S1 OFF. The setting is stored in memory and becomes active the next time power to the PM-15S1 is activated.

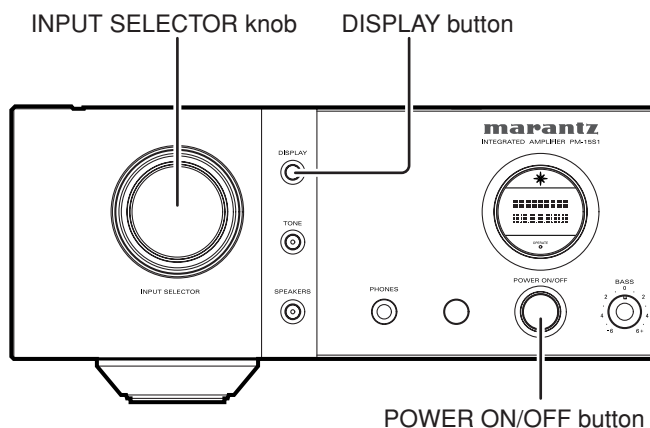



## HOW TO USE AND SET FEATURES

### REMOTE CONTROL JACKS

The REMOTE CONTROL jacks are for connecting components that are capable of remote control (D.BUS jacks) such as a Marantz Super Audio CD Player or DVD Player. This enables these other components to be operated with the remote controller included with the PM-15S1. The PM-15S1 comes with an RC-11PMS1 system remote controller that can operate the basic features of Marantz Super Audio CD Players and DVD Players. Here, a brief explanation of how to control the PM-15S1 and SA-15S1 using this remote controller is provided..

As shown in the illustration below, connect the REMOTE CONTROL "IN" jack of the SA-15S1 to the REMOTE CONTROL "OUT" jack of the PM-15S1, and set the SA-15S1 switch to "EXT".

Both the PM-15S1 and SA-15S1 can be operated by pointing the **RC-11PMS1 remote controller** (pg. 12, 13, 14, 15) at the receptor of the PM-15S1.

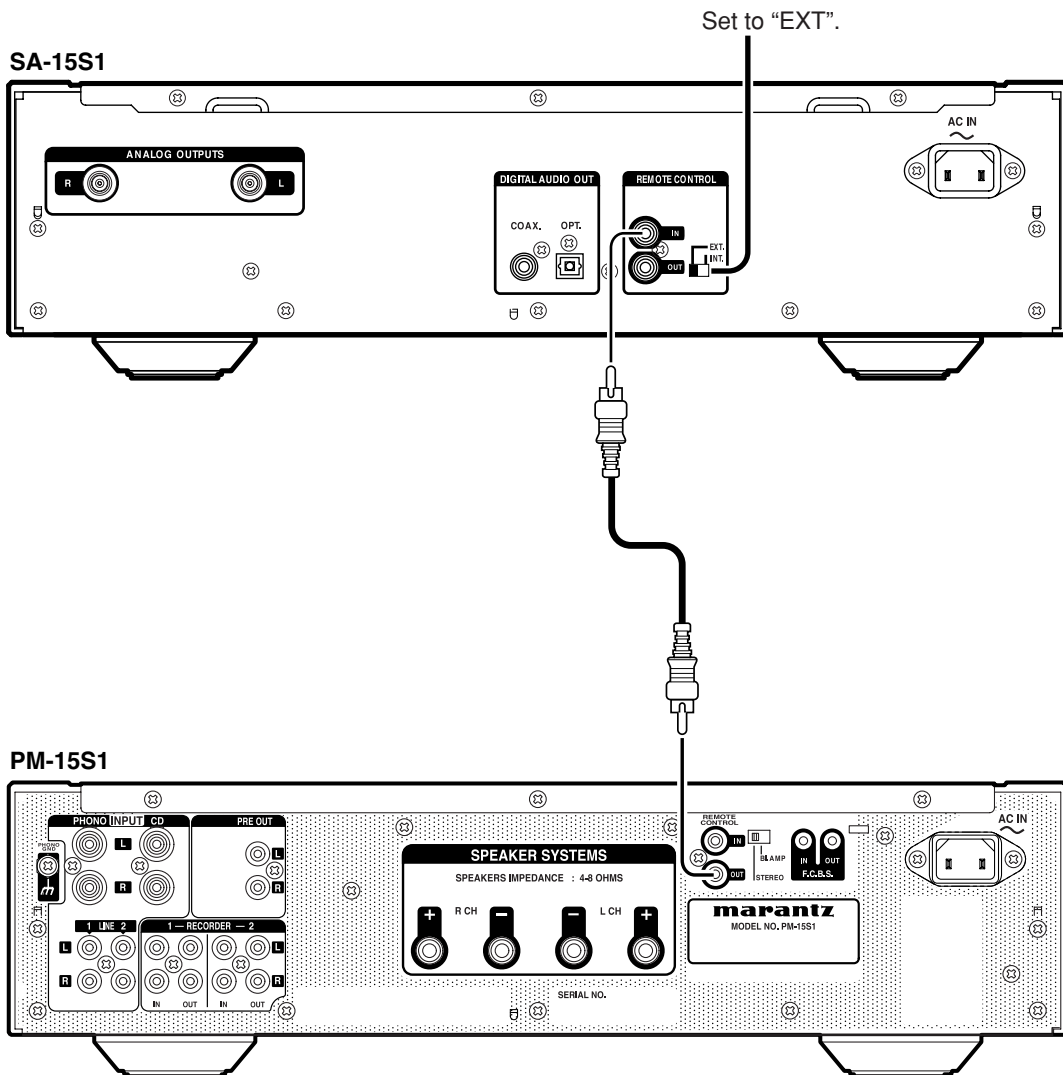

# TROUBLESHOOTING

If you experience trouble with the PM-15S1, make the below checks before thinking the worst. Improper operation can cause the PM-15S1 to behave in a way that makes you think something is wrong with the equipment when actually not. If the trouble cannot be fixed after making the below checks, contact the place of purchase, your nearest Marantz dealer, our customer service center or our repair service center.

## \* Power does not turn ON.

1. Is the power cable securely plugged into a power outlet?

## \* Nothing is heard from the speakers.

1. Aren't the SPEAKERS buttons on the front panel in the OFF position?
2. Isn't the attenuation feature (ATT.) active?
3. Isn't there trouble in the input source selected from the INPUT SELECTOR knob on the front panel?
4. Are you using the player (replaying device) correctly?
5. Are connection cables and speaker cables securely connected?
6. Volume may have been muted by a protective circuit that tripped. Try adjusting the volume level again.
7. If an error message is displayed, correctly set the ID number as indicated in the table under "Error Messages".

## \* Volume level differs between left and right channels.

The volume level setting may differ between the left and right channels. Try trimming the volume level again.

## \* Stereo sound is not heard from the speakers.

The operating mode switch on the rear panel may be set to "BI-AMP". Shut power OFF, set the switch to "STEREO" and then reactive the power. Power must be activated after the operating mode switch is set for the setting to be active.

## \* Record player audio is not heard or contains a lot of noise.

1. Is the PHONO MC button on the front panel set to the type of cartridge you are using?
2. Are connection cables securely connected?
3. Is the grounding wire from the record player connected to the PHONO GND terminal?
4. Is the cartridge properly connected to the tone arm?

## ■ About Protective Circuits

The PM-15S1 is equipped with protective circuits to protect the amplifier circuits and speaker system against damage. If a protective circuit trips, the sound is instantly muted. In this case, "PROTECT" flashes on the display panel.

### • At Power ON

For about 8 seconds after power is activated, a protective circuit trips and mutes the sound to give amplifier circuits time to stabilize. Once the amplifier circuits stabilize, the protective circuit releases and audio is enabled.

### • In the Event of Overcurrent

A protective circuit trips if current of a certain level is detected, which can happen if excessive signal flow is input to the amplifier or if the PM-15S1 is connected to a speaker system of less than 4 Ω impedance. A protective circuit can also trip if a speaker cable accidentally shorts. In these cases, "PROTECT" flashes on the display and, approximately 8 seconds later, the sound is automatically muted and the protective circuit is released. Therefore, readjust the volume level to resume normal use.

### • If Strong Bass Signals Are Input

A protective circuit trips if bass signals of an excessive level are detected. In this case, "PROTECT" flashes on the display and, approximately 8 seconds later, the sound is automatically muted and the protective circuit is released. Readjust the volume level to resume normal use.

### • If the Power Amplifier Overheats

A protective circuit trips if the temperature of the main amplifier rises above a certain level, which can happen if excessive signal flow is continually input into the amplifier. Temperature can also exceed the trip level of the protective circuits if the vents on the top of the PM-15S1 are covered or if the PM-15S1 is installed on a cramped audio rack. In these cases, "PROTECT" flashes on the display and, when the temperature inside the unit lowers, the sound is automatically muted and the protective circuit is released. Readjust the volume level to resume normal use.

## TROUBLESHOOTING

### ■ Error Messages

When multiple PM-15S1s are connected by FCBS, the below error messages may appear on the display. In these cases, there is a problem with the ID number setting or remote cable connection. Check the ID numbers and remote cable as indicated in the below table. For details on how to set ID numbers, see "How to Set ID" on pg. 19.

	Error message	Meaning	What to do
1	ERROR 02	ID 2 is used with more than one amp.	Set separate ID numbers for each amp.
2	ERROR 03	ID 3 is used with more than one amp.	
3	ERROR 04	ID 4 is used with more than one amp.	
4	ERROR 11	Amps of IDs 2 - 4 cannot communicate with ID 1 amp.	If power to ID 1 amp is OFF, activate power. Check remote cable is properly connected.
5	ERROR 12	ID 1 amp cannot communicate with amps of IDs 2 - 4.	If ID 1 is used for more than one amp, properly set ID numbers. Check remote cable is properly connected.

## OTHERS

The section describes the care and maintenance tasks that must be performed to optimize the operation of your Marantz equipment.

### ■ Cleaning of equipment external surfaces

The exterior finish of your unit will last indefinitely with proper care and cleaning. Never use scouring pads, steel wool, scouring powders or harsh chemical agents (e.g., lye solution), alcohol, thinner, benzene, insecticide or other volatile substances as these will mar the finish of the equipment. Likewise, never use cloths containing chemical substances. If the equipment gets dirty, wipe the external surfaces with a soft, lint-free cloth.

If the equipment becomes heavily soiled:

- dilute some washing up liquid in water, in a ratio of one part detergent to six parts water.
- dip a soft, lint free in the solution and wring the it is damp.
- wipe the equipment with the damp cloth.
- dry the equipment by wiping it with a dry cloth.



### ■ Repairs

Only the most competent and qualified service technicians should be allowed to service the factory-trained warranty station personnel have the knowledge and special facilities needed for repair and calibration of this precision equipment. After the warranty period has expired, repairs will be performed for a charge if the equipment can be returned to normal operation. In the event of difficulty, refer to your dealer or write directly to the nearest location to you that is listed on the Marantz Authorized Service Station list. If writing, please include the model and serial number of the equipment together with a full description of what you think is abnormal about the equipment's behaviour.

# SPECIFICATIONS & DIMENSIONAL DRAWINGS

Power output (20 Hz – 20 kHz simultaneous drive of both channels)  
 ..... 90W x 2 (8Ω load)  
 ..... 140W x 2 (4Ω load)  
 Total harmonic distortion (20Hz – 20kHz simultaneous drive of both channels, 8Ω load) ..... 0.05%  
 Output band width (8Ω load, 0.05%) ..... 5Hz ~ 40kHz  
 Frequency response (CD, 1W, 8Ω load) ..... 5Hz ~ 100kHz  
 Dumping factor (8Ω load, 20Hz – 20kHz) ..... 100  
 Input sensitivity/Input impedance  
 PHONO (MC) ..... 300μV/100Ω  
 PHONO (MM) ..... 3.2mV/47kΩ  
 CD/LINE/RECORDER ..... 240mV/20kΩ  
 Output voltage/Output impedance  
 PRE OUT ..... 1.7 V/330Ω  
 Maximum allowed PHONO input (1kHz)  
 MC ..... 15mV  
 MM ..... 150mV  
 RIAA deviation (20Hz ~ 20kHz) ..... ±0.5dB  
 S/N (IHF-A, 1W, 8Ω load)  
 PHONO (MC) ..... 77dB (0.5mV input)  
 PHONO (MM) ..... 85dB (5mV input)  
 CD/LINE/RECORDER ..... 90dB (500mV input)

Tone control  
 Bass (50Hz) ..... ±10dB  
 Treble (20kHz) ..... ±10dB  
 Power requirement ..... AC 230V 50Hz  
 Power consumption  
 (EN60065) ..... 220W  
 (4Ω, 140W x 2 output) ..... 550W  
 Accessories  
 Remote controller ..... 1  
 AAA batteries ..... 2  
 Detachable AC power cable ..... 1  
 Maximum outer dimensions (Amp)  
 Width ..... 440mm  
 Height ..... 123mm  
 Depth ..... 444mm  
 Weight (Amp) ..... 18.0kg

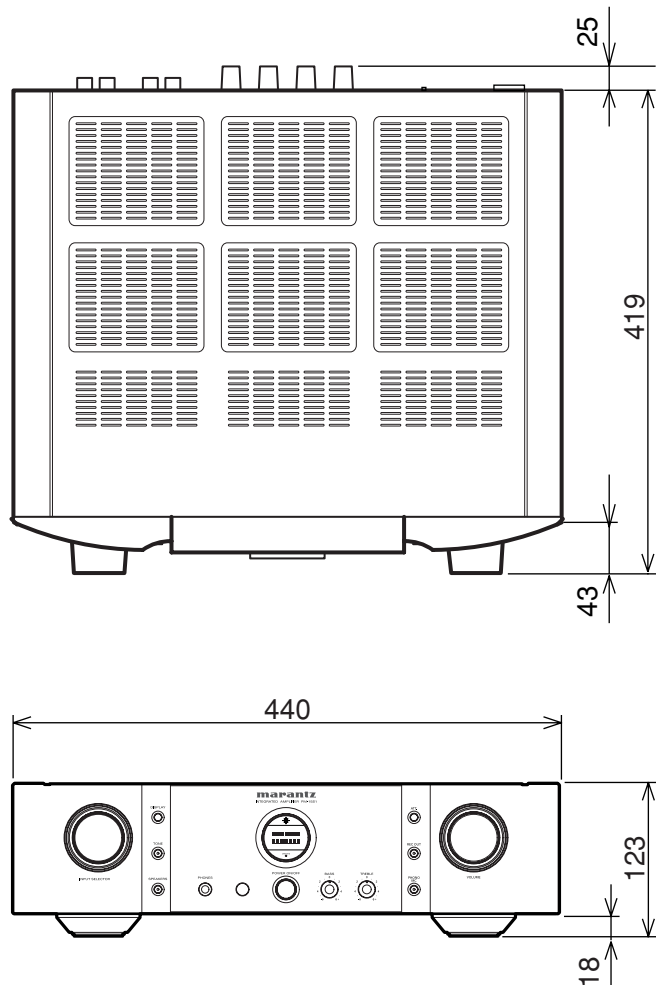

**www.marantz.com**

You can find your nearest authorized distributor or dealer on our website.

---

<b>JAPAN</b>	Marantz Japan, Inc.	35-1 Sagami Ohno 7-Chome, Sagamihara-shi, Kanagawa 228-8505, Japan
<b>U.S.A.</b>	Marantz America, Inc.	1100 Maplewood Drive, Itasca, IL 60143, U.S.A.
<b>EUROPE</b>	Marantz Europe B.V.	P.O. Box 8744, 5605 LS Eindhoven, The Netherlands

---

**marantz**<sup>®</sup> is a registered trademark.

