

ESPAÑOL

FRANÇAIS

ENGLISH



marantz®

CD Player
CD5004

User Guide

SAFETY PRECAUTIONS



CAUTION
RISK OF ELECTRIC SHOCK
DO NOT OPEN



CAUTION:
TO REDUCE THE RISK OF ELECTRIC SHOCK, DO NOT REMOVE COVER (OR BACK). NO USER-SERVICEABLE PARTS INSIDE. REFER SERVICING TO QUALIFIED SERVICE PERSONNEL.

The lightning flash with arrowhead symbol, within an equilateral triangle, is intended to alert the user to the presence of uninsulated "dangerous voltage" within the product's enclosure that may be of sufficient magnitude to constitute a risk of electric shock to persons.

The exclamation point within an equilateral triangle is intended to alert the user to the presence of important operating and maintenance (servicing) instructions in the literature accompanying the appliance.

WARNING:
TO REDUCE THE RISK OF FIRE OR ELECTRIC SHOCK, DO NOT EXPOSE THIS APPLIANCE TO RAIN OR MOISTURE.

CAUTION:
USE OF CONTROLS OR ADJUSTMENTS OR PERFORMANCE OF PROCEDURES OTHER THAN THOSE SPECIFIED HEREIN MAY RESULT IN HAZARDOUS RADIATION EXPOSURE. THIS PRODUCT SHOULD NOT BE ADJUSTED OR REPAIRED BY ANYONE EXCEPT PROPERLY QUALIFIED SERVICE PERSONNEL.

Laser Class (IEC 60825-1:2001)

CLASS 1 LASER PRODUCT
LUOKAN 1 LASERLAITE
KLASS 1 LASERAPPARAT

IMPORTANT SAFETY INSTRUCTIONS

1. Read these instructions.
2. Keep these instructions.
3. Heed all warnings.
4. Follow all instructions.
5. Do not use this apparatus near water.
6. Clean only with dry cloth.
7. Do not block any ventilation openings. Install in accordance with the manufacturer's instructions.
8. Do not install near any heat sources such as radiators, heat registers, stoves, or other apparatus (including amplifiers) that produce heat.
9. Do not defeat the safety purpose of the polarized or grounding-type plug. A polarized plug has two blades with one wider than the other. A grounding type plug has two blades and a third grounding prong. The wide blade or the third prong are provided for your safety. If the provided plug does not fit into your outlet, consult an electrician for replacement of the obsolete outlet.
10. Protect the power cord from being walked on or pinched particularly at plugs, convenience receptacles, and the point where they exit from the apparatus.
11. Only use attachments/accessories specified by the manufacturer.
12. Use only with the cart, stand, tripod, bracket, or table specified by the manufacturer, or sold with the apparatus. When a cart is used, use caution when moving the cart/apparatus combination to avoid injury from tip-over. 
13. Unplug this apparatus during lightning storms or when unused for long periods of time.
14. Refer all servicing to qualified service personnel. Servicing is required when the apparatus has been damaged in any way, such as power-supply cord or plug is damaged, liquid has been spilled or objects have fallen into the apparatus, the apparatus has been exposed to rain or moisture, does not operate normally, or has been dropped.
15. Batteries shall not be exposed to excessive heat such as sunshine, fire or the like.

CAUTION:

To completely disconnect this product from the mains, disconnect the plug from the wall socket outlet.

The mains plug is used to completely interrupt the power supply to the unit and must be within easy access by the user.

PRECAUTION:

Pour déconnecter complètement ce produit du courant secteur, débranchez la prise de la prise murale.

La prise secteur est utilisée pour couper complètement l'alimentation de l'appareil et l'utilisateur doit pouvoir y accéder facilement.

PRECAUCIÓN:

Para desconectar completamente este producto de la alimentación eléctrica, desconecte el enchufe del enchufe de la pared.

El enchufe de la alimentación eléctrica se utiliza para interrumpir por completo el suministro de alimentación eléctrica a la unidad y debe de encontrarse en un lugar al que el usuario tenga fácil acceso.

FCC INFORMATION (For US customers)

1. PRODUCT

This product complies with Part 15 of the FCC Rules. Operation is subject to the following two conditions: (1) this product may not cause harmful interference, and (2) this product must accept any interference received, including interference that may cause undesired operation.

2. IMPORTANT NOTICE: DO NOT MODIFY THIS PRODUCT

This product, when installed as indicated in the instructions contained in this manual, meets FCC requirements. Modification not expressly approved by Marantz may void your authority, granted by the FCC, to use the product.

3. NOTE

This product has been tested and found to comply with the limits for a Class B digital device, pursuant to Part 15 of the FCC Rules. These limits are designed to provide reasonable protection against harmful interference in a residential installation.

This product generates, uses and can radiate radio frequency energy and, if not installed and used in accordance with the instructions, may cause harmful interference to radio communications. However, there is no guarantee that interference will not occur in a particular installation. If this product does cause harmful interference to radio or television reception, which can be determined by turning the product OFF and ON, the user is encouraged to try to correct the interference by one or more of the following measures:

- Reorient or relocate the receiving antenna.
- Increase the separation between the equipment and receiver.
- Connect the product into an outlet on a circuit different from that to which the receiver is connected.
- Consult the local retailer authorized to distribute this type of product or an experienced radio/TV technician for help.

For Canadian customers:

This Class B digital apparatus complies with Canadian ICES-003.

Cet appareil numérique de la classe B est conforme à la norme NMB-003 du Canada.

☐ NOTES ON USE / OBSERVATIONS RELATIVES A L'UTILISATION / NOTAS SOBRE EL USO

WARNINGS	AVERTISSEMENTS	ADVERTENCIAS
<ul style="list-style-type: none"> • Avoid high temperatures. Allow for sufficient heat dispersion when installed in a rack. • Handle the power cord carefully. Hold the plug when unplugging the cord. • Keep the unit free from moisture, water, and dust. • Unplug the power cord when not using the unit for long periods of time. • Do not obstruct the ventilation holes. • Do not let foreign objects into the unit. • Do not let insecticides, benzene, and thinner come in contact with the unit. • Never disassemble or modify the unit in any way. • Ventilation should not be impeded by covering the ventilation openings with items, such as newspapers, tablecloths or curtains. • Naked flame sources such as lighted candles should not be placed on the unit. • Observe and follow local regulations regarding battery disposal. • Do not expose the unit to dripping or splashing fluids. • Do not place objects filled with liquids, such as vases, on the unit. • Do not handle the mains cord with wet hands. • When the switch is in the OFF position, the equipment is not completely switched off from MAINS. • The equipment shall be installed near the power supply so that the power supply is easily accessible. 	<ul style="list-style-type: none"> • Eviter des températures élevées. Tenir compte d'une dispersion de chaleur suffisante lors de l'installation sur une étagère. • Manipuler le cordon d'alimentation avec précaution. Tenir la prise lors du débranchement du cordon. • Protéger l'appareil contre l'humidité, l'eau et la poussière. • Débrancher le cordon d'alimentation lorsque l'appareil n'est pas utilisé pendant de longues périodes. • Ne pas obstruer les trous d'aération. • Ne pas laisser des objets étrangers dans l'appareil. • Ne pas mettre en contact des insecticides, du benzène et un diluant avec l'appareil. • Ne jamais placer de flamme nue sur l'appareil, notamment des bougies allumées. • Veillez à respecter les lois en vigueur lorsque vous jetez les piles usagées. • L'appareil ne doit pas être exposé à l'eau ou à l'humidité. • Ne pas poser d'objet contenant du liquide, par exemple un vase, sur l'appareil. • Ne pas manipuler le cordon d'alimentation avec les mains mouillées. • Lorsque l'interrupteur est sur la position OFF, l'appareil n'est pas complètement déconnecté du SECTEUR (MAINS). • L'appareil sera installé près de la source d'alimentation, de sorte que cette dernière soit facilement accessible. 	<ul style="list-style-type: none"> • Evite altas temperaturas. Permite la suficiente dispersión del calor cuando está instalado en la consola. • Maneje el cordón de energía con cuidado. Sostenga el enchufe cuando desconecte el cordón de energía. • Mantenga el equipo libre de humedad, agua y polvo. • Desconecte el cordón de energía cuando no utilice el equipo por mucho tiempo. • No obstruya los orificios de ventilación. • No deje objetos extraños dentro del equipo. • No permita el contacto de insecticidas, gasolina y diluyentes con el equipo. • Nunca desarme o modifique el equipo de ninguna manera. • La ventilación no debe quedar obstruida por haberse cubierto las aperturas con objetos como periódicos, manteles o cortinas. • No deberán colocarse sobre el aparato fuentes inflamables sin protección, como velas encendidas. • A la hora de deshacerse de las pilas, respete la normativa para el cuidado del medio ambiente. • No exponer el aparato al goteo o salpicaduras cuando se utilice. • No colocar sobre el aparato objetos llenos de líquido, como jarros. • No maneje el cable de alimentación con las manos mojadas. • Cuando el interruptor está en la posición OFF, el equipo no está completamente desconectado de la alimentación MAINS. • El equipo se instalará cerca de la fuente de alimentación de manera que resulte fácil acceder a ella.

☐ CAUTIONS ON INSTALLATION
PRÉCAUTIONS D'INSTALLATION
EMPLAZAMIENTO DE LA INSTALACIÓN

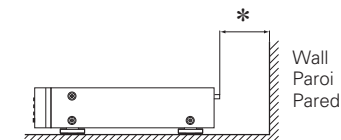
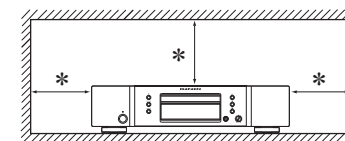

*** For proper heat dispersal, do not install this unit in a confined space, such as a bookcase or similar enclosure.**

- More than 0.1 m (4 in.) is recommended.
- Do not place any other equipment on this unit.

*** Pour permettre la dissipation de chaleur requise, n'installez pas cette unité dans un espace confiné tel qu'une bibliothèque ou un endroit similaire.**

- Une distance de plus de 0,1 m (4 po) est recommandée.
- Ne placez aucun matériel sur cet appareil.

*** Para la dispersión del calor adecuadamente, no instale este equipo en un lugar confinado tal como una librería o unidad similar.**

- Se recomienda dejar más de 0,1 m (4 pulg.) alrededor.
- No coloque ningún otro equipo sobre la unidad.

Getting started

Thank you for purchasing this Marantz product. To ensure proper operation, please read this owner's manual carefully before using the product. After reading the manual, be sure to keep it for future reference.

Contents

Getting started	1
Accessories	1
About this manual	1
Main features	2
Cautions on handling	3
Discs	3
Discs playable on this unit	3
Holding discs	3
Loading discs	3
Cautions on loading discs	3
Cautions on handling	4
Cautions on storing discs	4
Cleaning discs	4
About the remote control	4
Inserting the batteries	4
Operating range of the remote control	4
Part names and functions	5
Front panel	5
Display	5
Rear panel	6
Remote control	6
Basic connections	7
Preparations	7
Connecting cables	7
Analog connections	7
Connecting the power cord	7
Basic operation	8
Before use	8
Turning the power on	8
Turning the power standby	8
Playback CDs	8
Turning off display	9
To change time display	9
Displaying text	9
Listening with headphone	10
Playing repeatedly (Repeat Playback)	10
Repeat Playback Between Specified Points (A-B Repeat)	10
Playing in random order (Random playback)	11
Searching for a specific track (AMS play)	11

Advanced connections	12
Preparations	12
Connecting cables	12
Digital connections	12
Flasher input connector	12
Remote control connection	12

Advanced operations

Playing tracks in a specific order (Program playback)	13
Playback with unwanted tracks skipped (Delete program playback)	13
Playing back at different speeds (Pitch control function)	14
Setting higher quality sound (Audio EX function)	14
Performing menu settings	14
Peak (Peak level search)	15
Edit (Edit mode)	15
MP3/WMA Mode (File playback mode setting)	16
Digital Out (Digital audio output setting)	16
Quick Replay (Quick replay playback)	16
Auto Standby (Auto standby mode)	16
Playback of MP3 and WMA files	17
Playing MP3 and WMA files	18

Explanation of terms	20
Others	20

Troubleshooting

Specifications	22
-----------------------------	----

Index	22
--------------------	----

Accessories

Check that the following parts are supplied with the product.

① User guide	1
② AC power cord (Cord length: Approx. 4.9 ft / 1.5 m)	1
③ Audio connecting cable (Cord length: Approx. 3.3 ft / 1.0 m) ..	1
④ Remote control connecting cable	1
⑤ Remote controller (RC002CD)	1
⑥ AAA-size batteries	2
⑦ Warranty card (U.S.A.)	1
⑧ Warranty card (Canada)	1

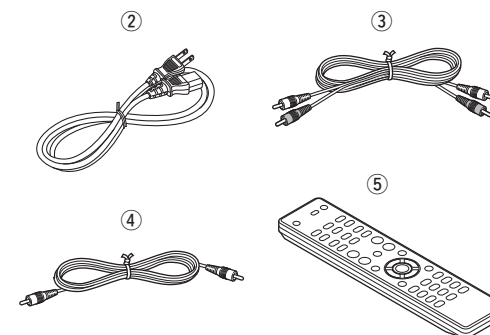

About this manual

Operation buttons

The operations described in this manual are based mainly on remote control operation.

Symbols



This symbol indicates a reference page on which related information is described.



This symbol indicates a supplementary information and tips for operations.

NOTE

This symbol indicates points to remember operations or function limitations.

Illustrations

Note that the illustrations in these instructions are for explanation purposes and may differ from the actual unit.

Main features

Using Marantz original HDAM®SA2

The unit uses an HDAM®SA2, whose quality has been proved in Super Audio CD players and high-end amplifiers, as a high-speed buffer amplifier.

You can enjoy the high speed and high-quality sound like that produced by high-end equipment.

Incorporates a Cirrus Logic advanced D/A converter, CS4392

The unit adopts CS4392 corresponding to Cirrus Logic 192 kHz/24 bit in a D/A converter, which is the important element for deciding sound quality, the same with the highly reputed Marantz Super Audio CD player. The Cirrus Logic converter is a high quality device that supports DVD-Audio content.

(This model is only suitable for reproduction of Audio CDs or MP3/WMA files)

Audio EX function

Audio EX mode, which allows setting of pitch control, digital output, and display function to OFF, is provided in order for you to enjoy higher quality sound (🔗 page 14).

High grade headphone circuit

The high-grade headphone circuit incorporates a high-speed buffer amplifier to enable headphone listening of high quality sound reproduction, late at night or in other such situations.

Supports MP3 and WMA file playback

MP3 and WMA files that have been recorded onto CD-R or CD-RW discs can be played back on this CD player (🔗 page 17).

Pitch control function (Audio CDs only)

The “pitch control” function enables the play speed (pitch) to be varied over a ± 12 step (🔗 page 14).

Quick replay function (Audio CDs only)

By a single-action operation, the “quick replay” function enables play to be moved back from the current play position for the time equivalent to the setting (setting range: 5 to 60 seconds) and play to be resumed.

This function makes it possible to return to a part of the track that was just played so it can be heard again (🔗 page 16).

Supports CD-Text display

CD-Text is an extension to the existing audio CD standard that enables text information, such as the name of the artist, album title and song titles to be stored on an audio CD.

CDs with the following logos support this function.



Text information is recorded on the parts that are not used in the conventional Audio CDs.

This CD player enables the text information stored on a CD-Text CD to be read (applies only to English alphanumeric text).

Cautions on handling

• Before turning the power switch on

Check once again that all connections are correct and that there are no problems with the connection cables.

- When leaving home for long periods of time, be sure to unplug the power cord from the power outlet.

• Proper ventilation

If the unit is left in a room full of the smoke from cigarettes, etc., for long periods of time, the surface of the optical pickup may get dirty, preventing it from receiving the signals properly.

• About condensation

If there is a major difference in temperature between the inside of the unit and its surroundings, condensation may form on parts inside the unit, causing the unit to fail to operate properly.

If this happens, let the unit sit for an hour or two with the power off and wait until there is little difference in temperature before using the unit.

• Cautions on using mobile phones

Using a mobile phone near this unit may result in noise. If that occurs, move the mobile phone away from the unit when it is in use.

• Moving the unit

Turn off the power and unplug the power cord from the power outlet. Next, disconnect the cables connected to other system units before moving the unit.

Discs

Discs playable on this unit

1 Music CDs

Discs marked with the logo at right can be played in this unit.



2 CD-R/CD-RW

NOTE

- Discs in special shapes (heart-shaped discs, octagonal discs, etc.) cannot be played. Do not attempt to play them, as doing so can damage the unit.
- Some discs and some recording formats cannot be played.
- Non-finalized discs cannot be played.



※ What is finalization?

Finalization is the process that makes recorded CD-R/CD-RW discs playable on compatible players.

Holding discs



Do not touch the signal surface.

Loading discs

- Place the disc in the tray, label side up.
- Make sure the disc tray is fully open when inserting the disc.
- Place the discs flat, 12 cm discs in the outer tray guide (Figure 1), 8 cm discs in the inner tray guide (Figure 2).

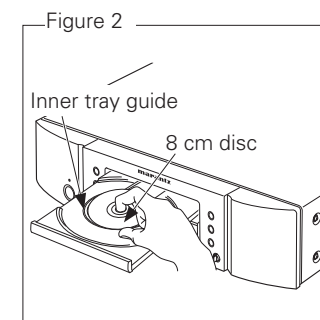
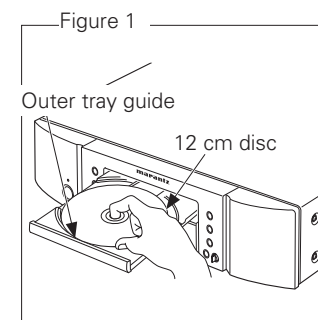

- Place 8 cm discs in the inner tray guide without using an adapter.

NOTE

- If you place a DVD or other disc that cannot be played by this unit in the disc tray, the tray does not open/close for about 1 minute. When that happens, press ▲ after "Error" is displayed.
- If you place a disc that contains other than MP3 or WMA files, "No File" is displayed.

Cautions on loading discs

- Only load one disc at a time. Loading two or more discs can damage the unit or scratch the discs.
- Do not use cracked or warped discs or discs that have been repaired with adhesive, etc.
- Do not use discs on which the sticky part of cellophane tape or labels is exposed or on which there are traces of where labels have been removed. Such discs can get caught inside the player and damage it.

Cautions on handling

- Do not get fingerprints, oil or dirt on discs.
- Take special care not to scratch discs when removing them from their cases.
- Do not bend or heat discs.
- Do not enlarge the hole in the center.
- Do not write on the labeled (printed) surface with ball-point pens, pencils, etc., or stick new labels on discs.
- Water droplets may form on discs if they are moved suddenly from a cold place (outdoors for example) to a warm place, but do not try to dry them off using a hairdryer, etc.

Cautions on storing discs

- Be sure to remove discs after using them.
- Be sure to store discs in their cases to protect them from dust, scratches, warping, etc.
- Do not store discs in the following places:
 1. Places exposed to direct sunlight for long periods of time
 2. Dusty or humid places
 3. Places exposed to heat from heaters, etc.

Cleaning discs

- If there are fingerprints or dirt on a disc, wipe them off before using the disc. Fingerprints and dirt can impair sound quality and cause interruptions in playback.
- Use a commercially available disc cleaning set or a soft cloth to clean discs.

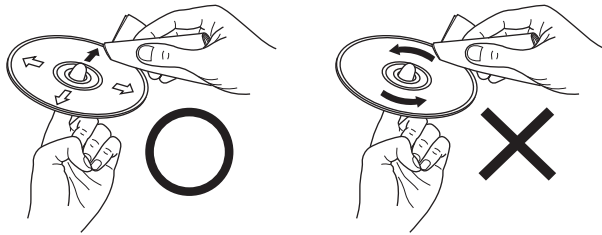

Gently wipe the disc from the inside towards the outside.

Do not wipe in a circular motion.

NOTE

Do not use record spray, antistatic agents, benzene, thinner or other solvents.

About the remote control

Inserting the batteries

- ① Remove the rear cover of the remote control.
- ② Set two R03/AAA batteries in the battery compartment in the indicated direction.

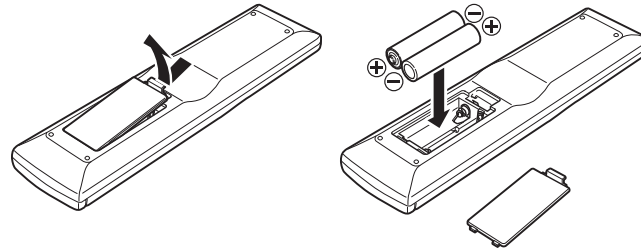

- ③ Put the rear cover back on.

NOTE

- Replace the batteries with new ones if the unit does not operate even when the remote control is operated close to the unit.
- The supplied batteries are only for verifying operation.
- Insert the batteries in the proper direction, following the “+” and “-” marks in the battery compartment.
- To prevent damage or leakage of battery fluid:
 - Do not use a new battery with an old one.
 - Do not use two different types of batteries.
 - Do not attempt to charge dry batteries.
 - Do not short-circuit, disassemble, heat or dispose of batteries in a fire.
 - Do not keep the battery in a place exposed to direct sunlight or in places with extremely high temperatures, such as near a heater.
- If the battery fluid leaks, carefully wipe the fluid off the inside of the battery compartment and insert new batteries.
- Remove the batteries from the remote control if it will not be used for a long time.
- Dispose of batteries in accordance with local regulations on battery disposal.

Operating range of the remote control

Operate the remote control while pointing it at the remote sensor.

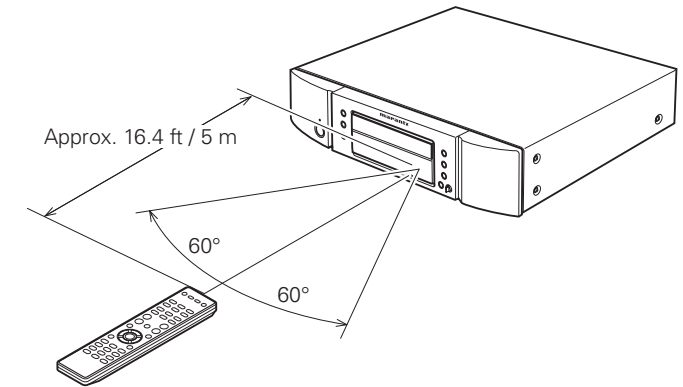

NOTE

The unit may function improperly or the remote control may not operate if the remote control sensor is exposed to direct sunlight or strong artificial light from a fluorescent or infrared light.

Part names and functions

For buttons not explained here, see the page indicated in parentheses ().

Front panel

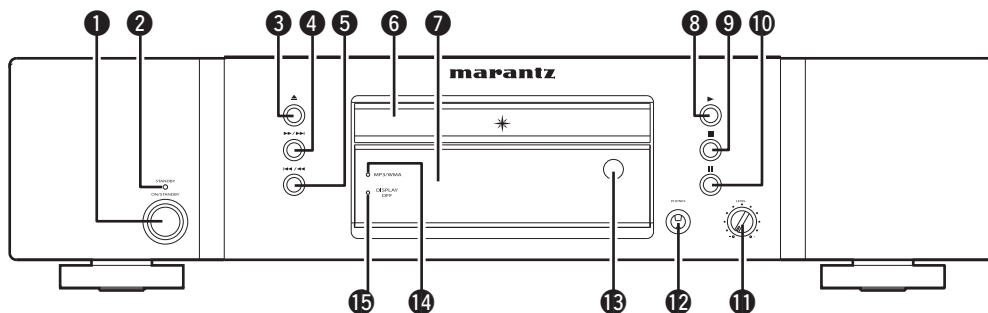

- 1 Power operation switch (ON/STANDBY)** (8)
- 2 Power indicator (STANDBY)** (8)
The two-colored light indicates the CD player operating status as follows:
• Power "ON" Turn off
• Standby Red
- 3 Disc tray open/close button (▲)** (8)
- 4 Fast forwarding/Forward-skip button (▶▶, ▶▶I)** (8)
- 5 Fast reversing/Reverse-skip button (I◀◀, ◀◀)** (8)
- 6 Disc tray** (8)
- 7 Display** (5)
- 8 Play button (▶)** (8)
- 9 Stop button (■)** (8)
- 10 Pause button (II)** (8)
- 11 Headphone volume control knob (LEVEL)** (10)
- 12 Headphones jack (PHONES)** (10)
- 13 Remote control sensor** (4)
- 14 MP3/WMA Indicator** (18)
- 15 DISPLAY OFF indicator** (9)

Display

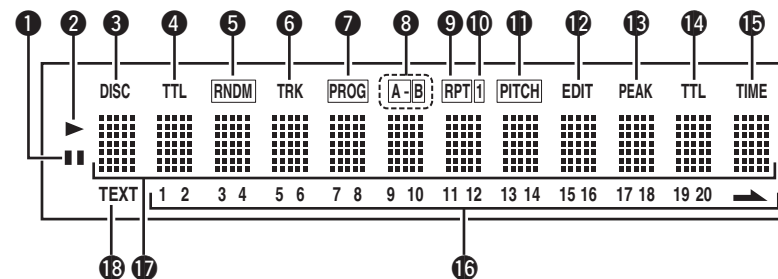

- 1 Pause indicator (II)**
This lights when play is temporarily suspended.
- 2 Play indicator (▶)**
This lights during play.
- 3 Disc indicator (DISC)**
This flashes during readout of the table of contents (TOC) information on the disc.
- 4 Total track indicator (TTL)**
Lights up when the total number of tracks recorded in the CD is displayed.
- 5 Random indicator (RNDM)**
This lights during random play.
- 6 Track indicator (TRK)**
Lights up when the track number of a track being played back is displayed.
- 7 Program indicator (PROG)**
This lights during program play.
- 8 A-B repeat indicator (A-B)**
This lights during A-B repeat play.
- 9 Repeat indicator (RPT)**
This lights during repeat play.
- 10 1-track repeat indicator (1)**
This lights during 1-track repeat play.
- 11 Pitch control indicator (PITCH)**
Lights up when the pitch control function is set and active.
- 12 Edit indicator (EDIT)**
This lights during edit mode.
- 13 Peak indicator (PEAK)**
This lights during peak search and playback of the peak.
- 14 Total time indicator (TTL)**
Lights up when the total remaining time or total program time is displayed.
- 15 Time indicator (TIME)**
This lights while the elapsed time or other such time is displayed.
- 16 Music calendar (1 - 20, ➡)**
This displays the track numbers recorded on the disc, the track numbers still to be played, and the track numbers programmed for program play. (Audio CD only)
- 17 Information display**
This displays the time information and text information of the disc played, the setting menus, etc.
- 18 Text indicator (TEXT)**
This lights when a disc supporting CD-TEXT has been loaded.

Rear panel

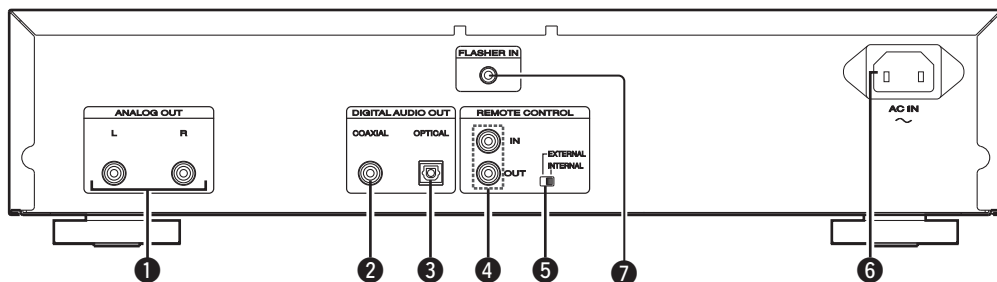

- 1 ANALOG OUT connectors (7)
- 2 DIGITAL OUT COAXIAL connector (12)
- 3 DIGITAL OUT OPTICAL connector (12)
- 4 REMOTE CONTROL IN / OUT connectors (12)
- 5 EXTERNAL/INTERNAL switch (12)
- 6 AC inlet (AC IN) (7)
- 7 Flasher input connector (12)

Remote control

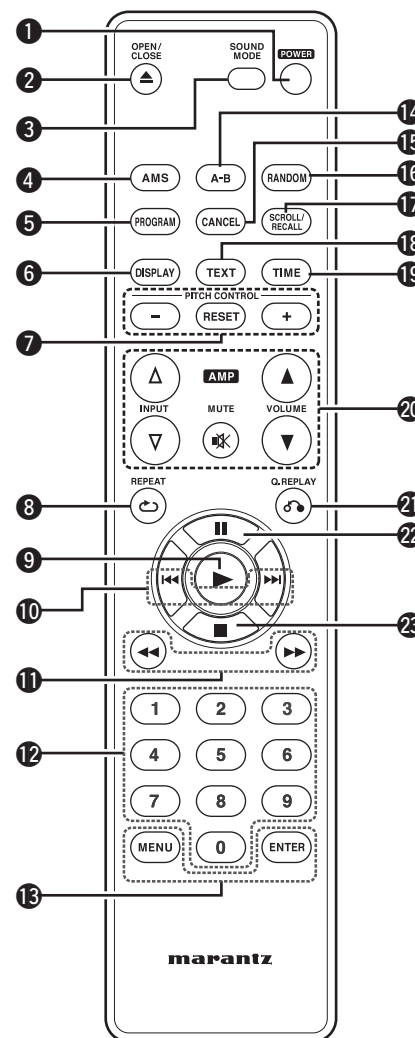

- 1 POWER button (8)
- 2 OPEN/CLOSE button (▲) (8)
- 3 SOUND MODE button (14)
- 4 Auto music scan button (AMS) (11, 19)
- 5 PROGRAM button (13)
- 6 DISPLAY button (9)
- 7 Pitch control down/reset/up buttons (-/RESET/+) (14)
- 8 REPEAT button (10, 18)
- 9 Play button (▶) (8)
- 10 Track skip buttons (◀◀, ▶▶) (8, 9)
- 11 Search buttons (◀◀, ▶▶) (8, 9)
- 12 Number buttons (0 - 9) (9)
- 13 MENU, ENTER button (14)
- 14 A-B repeat button (A-B) (10, 18)
- 15 CANCEL button (13)
- 16 RANDOM button (11, 19)
- 17 SCROLL/RECALL button (13)
- 18 TEXT button (9, 18)
- 19 TIME button (9)
- 20 Amplifier operation buttons
Volume button (▲, ▼)
Input button (▲, ▼)
MUTE button
- 21 Q. REPLAY button (16)
- 22 Pause button (⏸) (8)
- 23 Stop button (■) (8)



- The supplied remote control can operate Marantz amplifiers.
- When using it, also refer to the operating instructions of the other devices.

NOTE

The remote control may not operate some devices.

Basic connections

NOTE

- Do not plug in the power cord until all connections have been completed.
- When making connections, also refer to the owner's manual of the other components.
- Insert the plugs securely. Loose connections will result in the generation of noise.
- Be sure to connect the left and right channels properly (left with left, right with right).
- Do not bundle power cords together with connection cables. Doing so can result in humming or noise.
- Do not connect the unit to the PHONO input connectors on the amplifier.

Preparations

Connecting cables

Select the cables according to the equipment being connected.

Audio cables

Analog connections (stereo)



Audio cable (supplied)

Analog connections

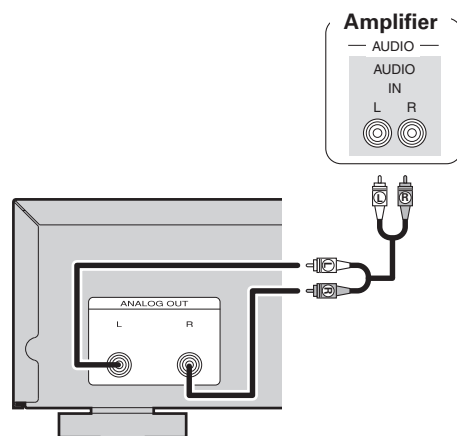

Connecting the power cord

Do not plug in the power cord until all connections have been completed.

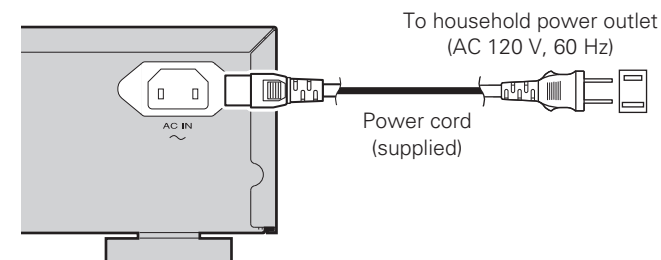

NOTE

- Insert the plugs securely. Loose connections will result in the generation of noise.
- Do not unplug the power cord while the unit is operating.
- Do not use a power cord other than the cord supplied with this unit.

Basic operation

Symbols used to indicate buttons in this manual

- Button located on both the main unit and the remote control → **BUTTON**
- Button only on the main unit → **<BUTTON>**
- Button only on the remote control → **[BUTTON]**

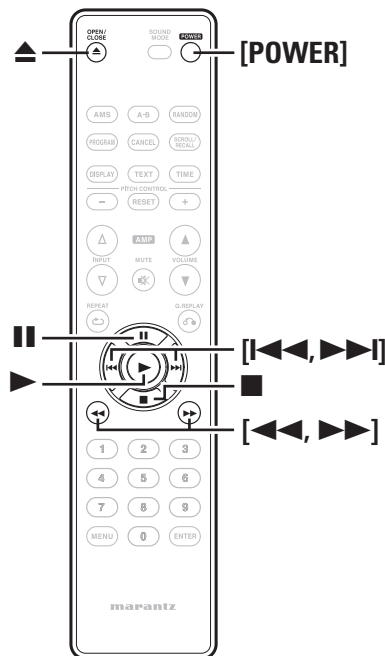
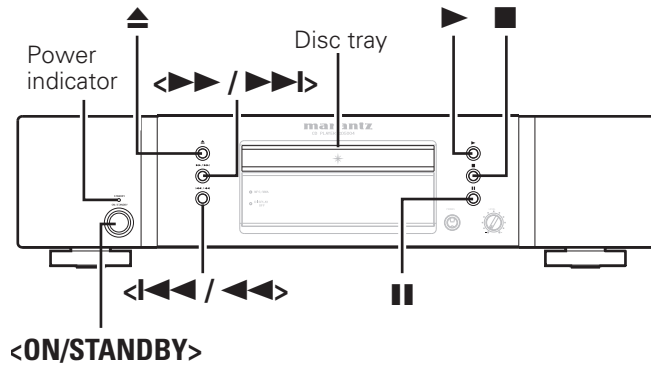

Before use

Turning the power on

Press **<ON/STANDBY>** or **[POWER]**.

Power is turned on and the power indicator goes off.

Turning the power standby

Press **<ON/STANDBY>** or **[POWER]**.

Power is set to standby and the power indicator lights.



Before setting power to standby, make sure the disc tray is completely closed.

NOTE

- Do not force the tray in by hand while power is set to standby. This could cause a trouble.
- Even when power is set to standby, electrical current passes through some circuits. If you do not intend to use the unit for an extended period of time, unplug the power cord from the household power outlet.

Playback CDs

1 Insert a disc.

- To open or close the disc tray, press **▲**.
- You can close the disc tray by pressing **▶**.

2 Press **▶**.

The "▶" indicator lights and the disc is played back.

- After playing all tracks recorded on the disc, the unit automatically stops playback.

Stopping Playback

Press **■**.

Stopping Playback temporarily

Press **||**.

- The "||" indicator lights.
- To restart playback, press **▶** or **||**.

Fast-Forwarding and Fast-Reversing (Searching)

[Using the buttons on the main unit]

During playback, press and hold in **<◀◀◀/◀◀◀>** or **<▶▶▶/▶▶▶>**.

- When you remove your finger from the button, normal playback is resumed.
- When normal playback is resumed after searching, the sound may be interrupted momentarily.

[Using the buttons on the remote control]

During playback, press and hold in **[◀◀◀]** or **[▶▶▶]**.

- When you remove your finger from the button, normal playback is resumed.
- When normal playback is resumed after searching, the sound may be interrupted momentarily.

Symbols used to indicate buttons in this manual

- Button located on both the main unit and the remote control → **BUTTON**
- Button only on the main unit → **<BUTTON>**
- Button only on the remote control → **[BUTTON]**

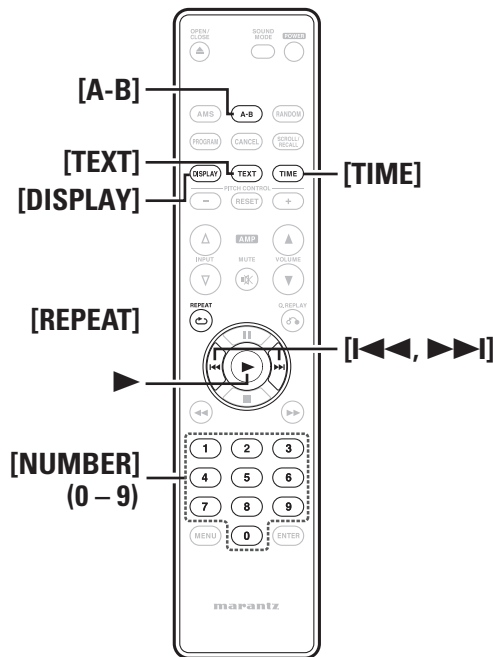
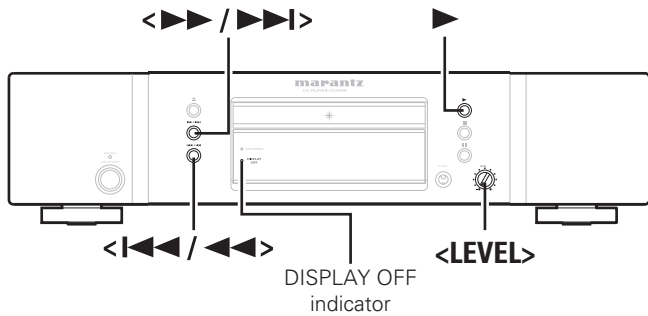

Playback CDs

Moving to the Beginning of Tracks (Skipping)

[Using the buttons on the main unit]

During playback, press <I-LL/LLI> or <I-LL/LLI>.

- The disc is skipped the number of tracks equal to the number of times the button is pressed.
- When you press <I-LL/LLI> once, playback restarts from the beginning of the current track.

[Using the buttons on the remote control]

During playback, press and hold in [I-LL] or [LLI].

- The disc is skipped the number of tracks equal to the number of times the button is pressed.
- When you press [I-LL] once, playback restarts from the beginning of the current track.

Playing a Specific Track (Direct searching)

Press [NUMBER] (0 – 9) to select the track.

[Example] : Track 4 : Press number [4] to select Track No. 4.

[Example] : Track 12 : Press numbers [1] and [2] consecutively to select Track No. 12.



The number you enter is set about 1.5 seconds after you press the number buttons. To enter a two-digit number, be sure to press the two number buttons, one immediately after the other.

Turning off display

Press [DISPLAY].

The DISPLAY OFF indicator lights and the display information goes off.

NOTE

During stop mode, the display information does not turn off. The information is turned off only during playback.

To change time display

Press [TIME].

- When [TIME] is pressed each time, the display shows differently in the following orders.

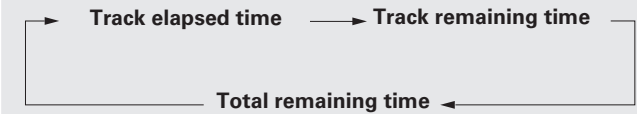

Displaying text

The "TEXT" indicator lights when a CD-Text disc is loaded.

- When you press [TEXT], the text information stored on a CD-Text disc is displayed.
- This unit can display up to 64 characters of text information.

[Display of player]

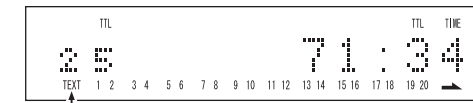

Text information

Displaying text

❑ During playback mode

When [TEXT] is pressed each time, the display switches text information in the following order.
 [Example] While the third track is being played back

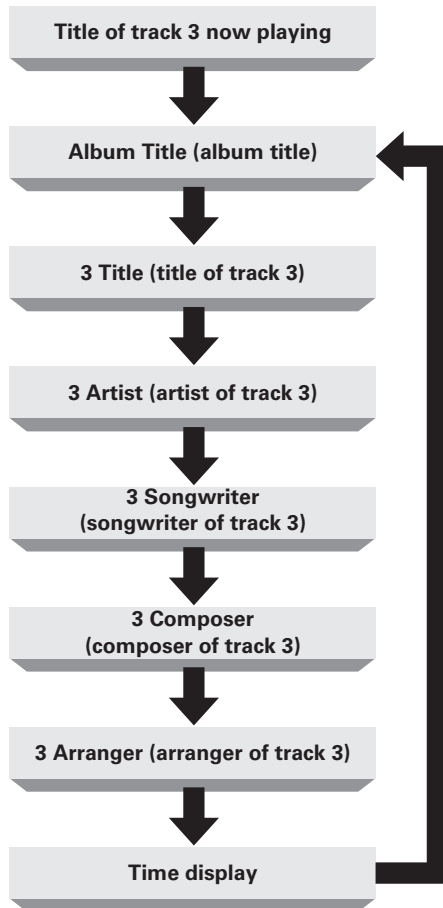

❑ During stop mode

When [TEXT] is pressed each time, the display switches text information in the following order.
 If you press ► while the title of a track is displayed, playback starts from the beginning of the current track.

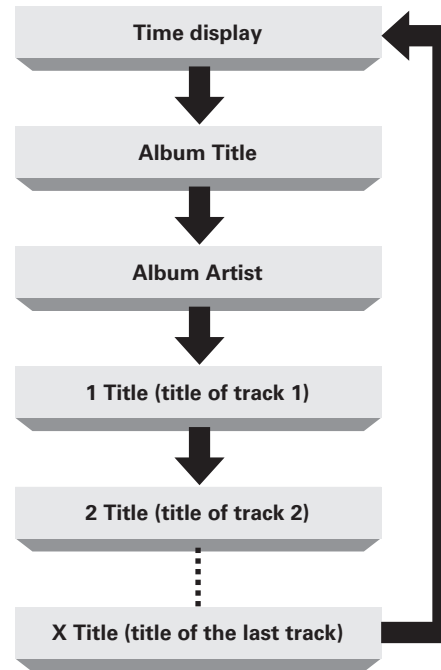

The type of text information stored in a CD-Text disc varies depending on the disc. No text information is displayed for the disc that does not contain information.

Listening with headphone

Plug the headphones into the headphone jack (PHONES).

Adjusting the Volume

Turn <LEVEL>.

NOTE

To prevent hearing loss, do not raise the volume level excessively when using headphones.

Playing repeatedly (Repeat Playback)

Press [REPEAT] to select repeat mode.

When [REPEAT] is pressed each time, the display switches repeat modes in the following order.



[Selectable items]

- All-track repeat "RPT" : All tracks are played repeatedly.
- 1-track repeat "RPT1" : Only 1 track is played repeatedly.
- Repeat off (Not Displayed) : Normal playback resumes.

Repeat Playback Between Specified Points (A-B Repeat)

- 1 During playback, press [A-B] at the desired starting point (A).
 The "A-" indicator on the display lights.
 - 2 Press the [A-B] again at the desired ending point (B).
 The "B" indicator on the display lights and the selected part (from point A to point B) is played repeatedly.
- To stop A-B repeat playback and resume normal playback, press [A-B] again. The "A-B" indicator goes off.



You cannot use the A-B repeat playback function during random playback.

Symbols used to indicate buttons in this manual

- Button located on both the main unit and the remote control → **BUTTON**
- Button only on the main unit → **<BUTTON>**
- Button only on the remote control → **[BUTTON]**

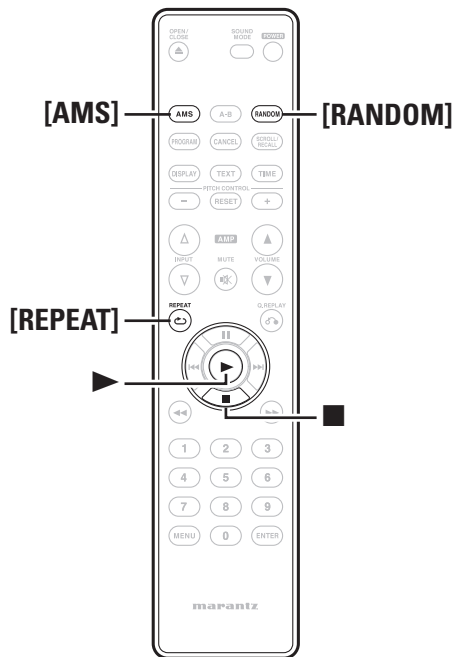
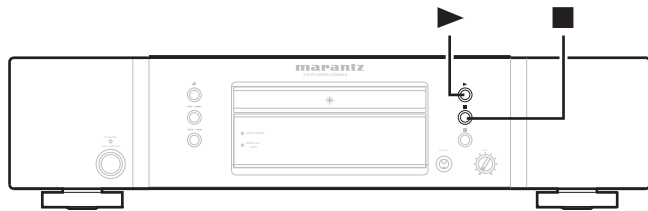

Playing in random order (Random playback)

During playback or stop mode, press [RANDOM].

The "RNDM" indicator on the display lights and random playback starts.

Stopping Random Playback

Press **■** or **[RANDOM]** during random playback. The "RNDM" indicator on the display goes off.



If you press **[REPEAT]** during random playback, playback is performed using the 1-track repeat or all-track repeat mode.

- All-track repeat: After the current session of random playback ends, another session is started using a different order for the tracks. This operation is repeated until you cancel the all-track repeat mode.
- 1-track repeat: The current track is played repeatedly.

NOTE

- Direct searching is not possible during random playback.
- The random playback mode is canceled if you set power to standby, turn off power, or open the disc tray.

Searching for a specific track (AMS play)

You can play back all track intros, from the first track onward, in sequence. This function is useful when you search for a specific track you want to listen to. (AMS playback: Auto Music Scan playback)

1 During playback or stop mode, press [AMS].

The Play indicator "▶" on the display flashes and AMS playback starts.

2 Press [AMS] to set the playback time.

- When **[AMS]** is pressed each time, the display switches AMS playback time in the following order.



3 When you find the track you want to listen to, press ▶.

The Play indicator "▶" lights and normal playback is resumed.

- If you press **[RANDOM]** during AMS playback, the AMS playback mode is canceled and random playback starts.

Advanced connections

Preparations

Connecting cables

Select the cables according to the equipment being connected.

Audio cables

Optical digital connections



Optical cable (sold separately)

Coaxial digital connections



Coaxial digital cable (sold separately)

Remote control connection



Remote connector cord (supplied)

Digital connections

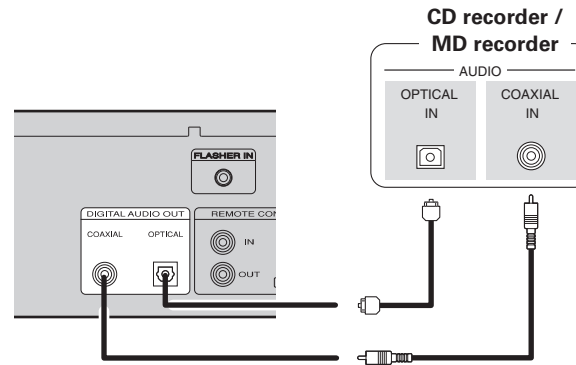

When connecting the optical digital output connector with an optical transmission cable (sold separately)

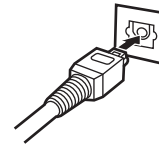

Match the shapes then insert firmly.

Flasher input connector

- This is used to control this unit using a keypad from another room. Set this switch to "EXT."
- If a flasher input connector is to be used, do not use the remote control input connector.

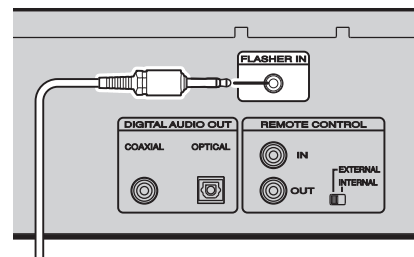

Remote control connection

When you use this unit connected to a Marantz amplifier, this unit receives operation signals sent from the amplifier and operates accordingly.

Connection

Use the supplied remote connection cable to connect the REMOTE CONTROL IN terminal of this unit to REMOTE CONTROL OUT terminal of the amplifier.

Setting

Set the remote control switch on the rear panel of this unit to "EXTERNAL" to use this feature.

- This setting will disable remote sensor reception of this unit.
- To operate the unit, point the remote control at the remote sensor of the amplifier.



To use this unit without connecting it to the amplifier, set the remote control switch to "INTERNAL".

The unit

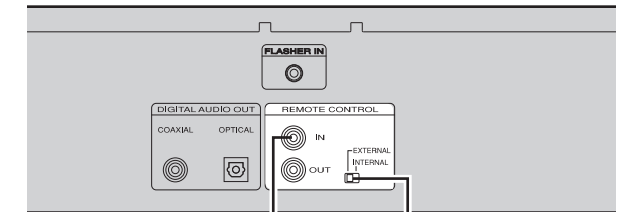

Set to "EXTERNAL."

Remote connector cord (supplied)

➔ : Signal flow

Amplifier

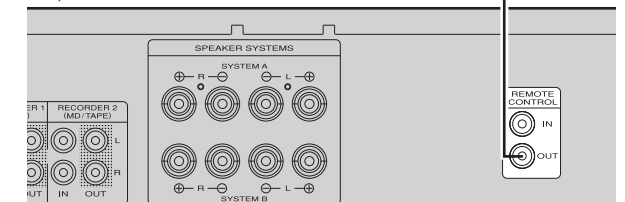

Advanced operations

Symbols used to indicate buttons in this manual

- Button located on both the main unit and the remote control → **BUTTON**
- Button only on the main unit → **<BUTTON>**
- Button only on the remote control → **[BUTTON]**

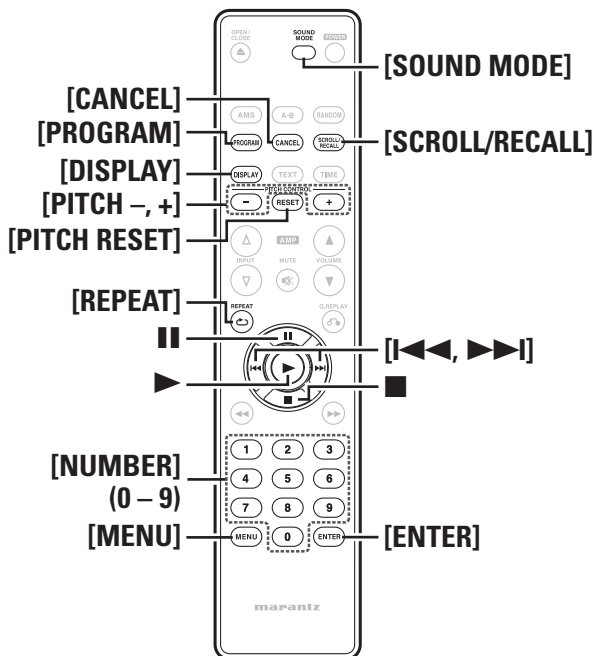

Playing tracks in a specific order (Program playback)

1 During stop mode, press **[PROGRAM]**.

- “Program” appears on the display and the program playback mode starts.
- The “PROG” indicator flashes.

2 Use **[NUMBER] (0 – 9)**, **[|◀◀, ▶▶|]** or **<|◀◀/▶▶|**, **▶▶/▶▶>** to select the tracks you want to program.

[Example]
To program tracks 3 and 12 to be played in that order, press **[3]**, **[1]**, and **[2]** one after the other.

3 Press **▶**.

Playback starts in the programmed order.



The number you enter is set about 1.5 seconds after you press the number buttons. To enter a two-digit number, be sure to press the two number buttons, one immediately after the other.

Playback with unwanted tracks skipped (Delete program playback)

1 After pressing **[PROGRAM]** during stop mode, press **[CANCEL]**.

- “Delete Prog.” appears on the display and delete program playback mode starts.
- “PROG” indicator flashes.

2 Use **[NUMBER] (0 – 9)**, **[|◀◀, ▶▶|]** or **<|◀◀/▶▶|**, **▶▶/▶▶>** to select the tracks you want to skip.

[Example]
To program tracks 3 and 12 to play in that order: Press **[3]**, **[1]** and **[2]**.

3 Press **▶**.

The selected tracks are skipped when the disc is played back.



The number you enter is set about 1.5 seconds after you press the number buttons. To enter a two-digit number, be sure to press the two number buttons, one immediately after the other.

Checking the order of the programmed tracks

- Press **[SCROLL/RECALL]**.
- During program playback: Displays the track numbers in the programmed order.
 - During delete program playback: Displays the deleted track numbers in the deleted order.

Adding tracks for program playback

- During playback or stop, press **[PROGRAM]**.
- When the “PROG” indicator flashes, select tracks that you want to add for program playback.

Canceling a track from program playback

- While stopped, press **[SCROLL/RECALL]**.
- Press **[SCROLL/RECALL]** to display the track that you want to delete and press **[CANCEL]**.

Clearing the all programmed track

- During program playback, press **■** twice.
- During stop mode, press **■** once.



- You can specify up to 30 tracks each for program playback and delete program playback.
- If you press **[REPEAT]** during program playback or delete program playback, programmed tracks are repeatedly played in the selected repeat mode (1-track repeat or all-track repeat).
- During 1-track repeat: The current track is played repeatedly.
- During all-track repeat: After the current session of program playback ends, the tracks are played repeatedly from the first programmed track. This operation is repeated until you cancel the all-track repeat mode.

NOTE

- Programmed playback is not possible with MP3 and WMA files.
- The program playback mode is canceled if you set power to standby, turn off power, or open the disc tray.

Playing back at different speeds (Pitch control function)

You can use the Pitch control function to play back music CDs (CD-DA) at a different speed (pitch) during playback.

Increasing the play speed

Press **[PITCH+]**.

- “PITCH” will light up and each time the button is pressed, the playback speed will increase (max +12).

Reducing the play speed

Press **[PITCH-]**.

- “PITCH” will light up and each time the button is pressed, the playback speed will decrease (min -12).

Returning play to the normal speed

Press **[PITCH RESET]**.

- The “PITCH” indicator on the display goes off and “Pitch: 0” appears on the main display.
- Press **[PITCH RESET]** again to restore the original playback speed setting.

NOTE

- The pitch control function is enabled only when Audio EX mode is set to “Audio EX OFF” (page 14).
- Pitch control playback is not possible with MP3 and WMA files.

Setting higher quality sound (Audio EX function)

You can use the Audio EX function to set higher quality sound.

During stop mode, press **[SOUND MODE]**.

- When **[SOUND MODE]** is pressed each time, the display switches sound modes in the following order.

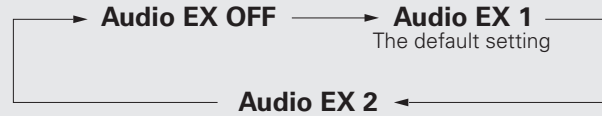

Sound mode	Pitch control	Digital output	Display
Audio EX OFF:	Enable	Available *1 *2	On
Audio EX 1: Plays with a higher quality sound than “Audio EX OFF” mode.	Disable	Available *2	On
Audio EX 2: Plays analog audio output using highest quality sound.	Disable	Not available	Off (during playback) *3

(*1) Digital signals are output only when the pitch control setting is “Pitch: 0”.

(*2) The “Digital Out” setting of the menu overrides the Audio EX setting (page 16).

(*3) When you press **[DISPLAY]**, the display turns on for about 3 seconds.

Performing menu settings

You can set the following functions. For further information, see the page indicated in parentheses ().

- Peak (Peak level search)** (page 15)
- Edit (Edit mode)** (page 15)
- MP3/WMA Mode (File playback mode setting)** (page 16)
- Digital Out (Digital audio output setting)** (page 16)
- Quick Replay (Quick replay playback)** (page 16)
- Auto Standby (Auto standby mode)** (page 16)

1 During stop mode, press **[MENU]**.

2 Press **■** or **||** to select the menu item you want to set.

3 Press **[ENTER]**.

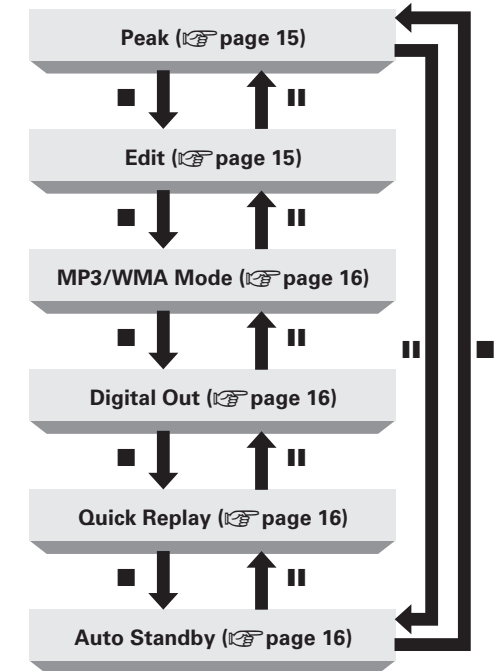

3 Press [ENTER] to end the setting operation.

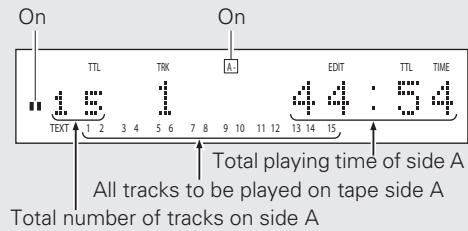

NOTE

- During edit playback, you can operate only <◀>, <▶>, and <ON/STANDBY> buttons on the main unit. (You cannot use the remote control for operation.) This prevents recording errors due to unintentional operation.
- During edit playback, no text information stored on a CD-Text disc is displayed. Only the time is displayed.
- With Auto Standby On, you can automatically set this unit to standby mode after the unit is in stop mode continuously for about 30 minutes, during setting in the Edit mode or edit playback.

□ Edit recording

1 After you finish settings in the edit mode, set the cassette deck to start recording.

2 Press ▶ or II to play back the tracks on side A.

Playback starts after about 4 seconds.

- When playback for recording tracks on side A ends, the recording stops temporarily at the beginning of the first track to be recorded on side B.

3 Change the cassette tape to side B and start recording.

4 Press ▶ or II to play back the tracks on side B.

Playback starts after about 4 seconds.

- When playback for recording tracks on side B ends, the recording stops and the settings in the edit mode are canceled.



You can perform edit recording during the program mode and delete program mode.

MP3/WMA Mode (File playback mode setting)

You can select the playback mode for MP3/WMA files.

1 Select “MP3/WMA Mode” and press [ENTER].

- The default setting is “Cont. mode”.

2 Press [◀◀, ▶▶] or <◀◀/◀◀, ▶▶/▶▶> to select the playback mode.

Cont. mode: All files on the disc are played.

Folder mode: All files in the selected folder are played.

- This unit can play MP3 and WMA files.

3 Press [ENTER].

The setting is saved.

Digital Out (Digital audio output setting)

You can prevent analog audio circuits from being affected by digital audio circuits by turning off the digital audio output. You can use higher quality sound to play back analog sounds.

1 Select “Digital Out” and press [ENTER].

The current settings appear on the display.

- Digital output is set to “On” at the factory.

2 Press [◀◀, ▶▶] or <◀◀/◀◀, ▶▶/▶▶> to select “On” or “Off”.

Off: Turns off digital audio output.

On: Turns on digital audio output.

3 Press [ENTER].

The setting is saved.

Quick Replay (Quick replay playback)

Using the quick replay function

When you press [Q.REPLAY] during playback, the play position will jump back from the current position for length of time that was set and playback is resumed.

NOTE

- You cannot cross over from one track to another when you perform the quick replay function.
- When you press [Q.REPLAY], if the total length of the track being played or the track elapsed playing time is shorter than the time set for quick replay, the play position will return to the beginning of the track and playback is resumed.

Setting the quick replay time

If a disc is set in the disc tray, remove the disc and then perform the setting.

1 Select “Quick Replay” and press [ENTER].

The quick replay time current setting appears on the display.

Q. Rep: 10Sec

- The quick replay time is set to 10 seconds at the factory.

2 Press [◀◀, ▶▶] or <◀◀/◀◀, ▶▶/▶▶> to set the desired time (5 – 60 seconds).

3 Press [ENTER].

The setting is saved.

Auto Standby (Auto standby mode)

With Auto Standby On, you can automatically set this unit to standby mode after the unit is in stop mode continuously for about 30 minutes (no operation).

1 Select “Auto Standby” and press [ENTER].

The Auto Standby mode current setting appears on the display.

- Auto Standby mode is set to “OFF” at the factory.

2 Press [◀◀, ▶▶] or <◀◀/◀◀, ▶▶/▶▶> to make the desired setting.

- ON: Enable Auto Standby mode.
- OFF: Disable Auto Standby mode.

3 Press [ENTER].

The setting is saved.

Symbols used to indicate buttons in this manual

- Button located on both the main unit and the remote control → **BUTTON**
- Button only on the main unit → **<BUTTON>**
- Button only on the remote control → **[BUTTON]**

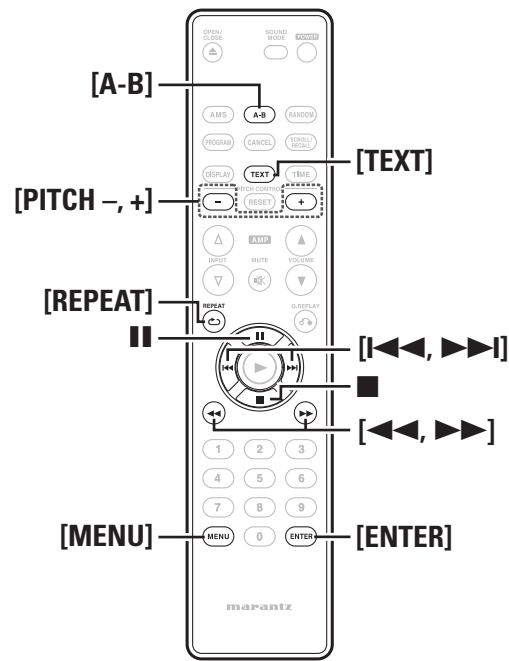
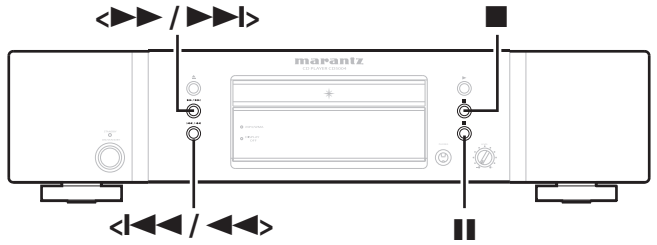

Playback of MP3 and WMA files

Playback order of MP3/WMA files

Example of MP3/WMA playback order

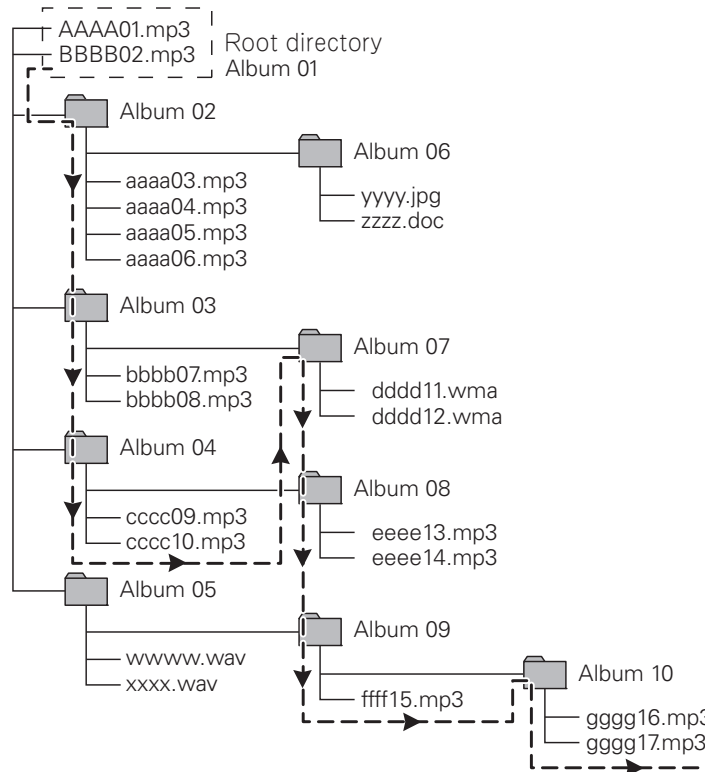

Playback order

- | | |
|--------------|---------------|
| 1 AAAA01.mp3 | 10 cccc10.mp3 |
| 2 BBBB02.mp3 | 11 dddd11.wma |
| 3 aaaa03.mp3 | 12 dddd12.wma |
| 4 aaaa04.mp3 | 13 eeee13.mp3 |
| 5 aaaa05.mp3 | 14 eeee14.mp3 |
| 6 aaaa06.mp3 | 15 ffff15.mp3 |
| 7 bbbb07.mp3 | 16 gggg16.mp3 |
| 8 bbbb08.mp3 | 17 gggg17.mp3 |
| 9 cccc09.mp3 | |

Display while the player is stopped



- The dotted lines with arrows indicate the playback order of files and folders.
- If there are any MP3/WMA files located immediately below the root directory, i.e. that are not in folders, they will be played before the folder files.
- The playback order will depend on the folder names and file names with the order of precedence being: numbers → alphabet upper case → alphabet lower case.
- The files in Albums 05 and 06 are not played back because they are not MP3/WMA files.
- It is possible that the playback order will be different than that of the order displayed on a personal computer. This order can also change according to the CD writing software used.

□ Displaying text information

When [TEXT] is pressed each time, the display switches text information in the following order.

During playback, mainly information about the currently playing file will be displayed.

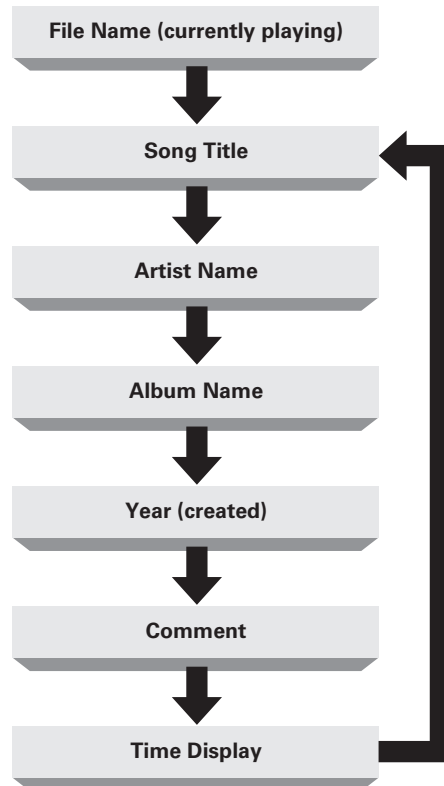

- Only alphanumeric characters can be displayed.
- The type of text information recorded in a file can be different depending on the method used to write a file and the CD writing software. Unrecorded text information is not displayed.
- When a CD is not playing, only the number of files on the disc that can be played is displayed.

NOTE

Depending on the MP3 or WMA file being played, text information may not be displayed.

Playing MP3 and WMA files

- 1 Set a CD-R/RW disc that contains MP3 or WMA format music files in the disc tray (☞ page 3).
- 2 Press [MENU] to select “MP3/WMA Mode”. Set “Cont. mode” or “Folder mode” (☞ page 16).

To Switch the Folder or File During Playback

[To change a folder]

Use [PITCH -, +] to select a folder and press [ENTER].

[To change a file]

Use [◀◀, ▶▶] or <◀◀/▶▶, ▶▶/▶▶> to select a file.



When you use a CD-R/RW disc, this unit automatically sets the playback order. For further information, refer to “Playback of MP3 and WMA files” (☞ page 17).

Stopping Playback

Press ■.

Stopping Playback temporarily

Press ■■.

The “■■” is displayed.

- To restart playback, press ■■ again.

Fast-Forwarding and Fast-Reversing (searching)

During playback, press and hold in [◀◀, ▶▶] or <◀◀/▶▶, ▶▶/▶▶>.

- When you remove your finger from the button, normal playback is resumed.
- When normal playback is resumed after searching, the sound may be interrupted momentarily.

□ Playing repeatedly (Repeat playback)

Press [REPEAT] to select repeat mode.

- When [REPEAT] is pressed each time, the display switches repeat modes in the following order.



[Selectable items]

- | | |
|-----------------------------|---|
| All-track repeat “RPT” | : All tracks are played repeatedly. |
| Folder repeat “RPT” flashes | : Tracks in a folder are played repeatedly. |
| 1-track repeat “RPT1” | : Only 1 track is played repeatedly. |
| Repeat off (Not Displayed) | : Normal playback resumes. |

□ Repeat Playback Between Specified Points (A-B Repeat)

- 1 During playback, press [A-B] at the desired starting point (A).
The “A-” indicator on the display lights.

- 2 Press the [A-B] again at the desired ending point (B).
The “B” indicator on the display lights and the selected part (from point A to point B) is played repeatedly.

- To stop A-B repeat playback and resume normal playback, press [A-B] again. The “A-B” indicator goes off.

NOTE

- The A-B repeat play function cannot be used during random play.
- There are cases in which difficulties will be experienced, when setting the B point, if the file’s bit rate is low.

Symbols used to indicate buttons in this manual

- Button located on both the main unit and the remote control → **BUTTON**
- Button only on the main unit → **<BUTTON>**
- Button only on the remote control → **[BUTTON]**

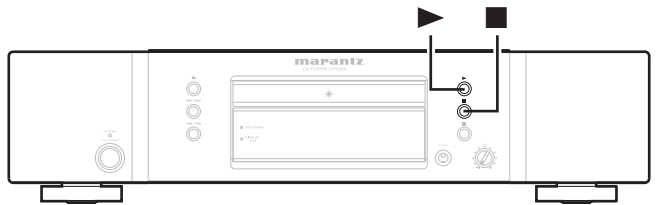

Playing in random order (Random playback)

During playback or stop mode, press [RANDOM].
 The "RNDM" indicator on the display lights and random playback starts.

Stopping Random Playback

Press **■** or **[RANDOM]** during random playback. The "RNDM" indicator on the display goes off.



If you press **[REPEAT]** during random playback, playback is performed using the 1-track repeat or all-track repeat mode.

- All-track repeat: After the current session of random playback ends, another session is started using a different order for the tracks. This operation is repeated until you cancel the all-track repeat mode.
- 1-track repeat: The current track is played repeatedly.

NOTE

The random playback mode is canceled if you set power to standby, turn off power, or open the disc tray.

Searching for a specific track (AMS play)

You can play back all track intros, from the first track onward, in sequence. This function is useful when you search for a specific track you want to listen to. (AMS playback: Auto Music Scan playback)

1 During playback or stop mode, press [AMS].
 The play indicator "▶" on the display flashes and AMS playback starts.

2 Press [AMS] to set the playback time.

- When **[AMS]** is pressed each time, the display switches AMS playback time in the following order.

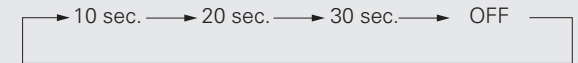

3 When you find the track you want to listen to, press ▶.

The Play indicator "▶" lights and normal playback is resumed.

- If you press **[RANDOM]** during AMS playback, the AMS playback mode is canceled and random playback starts.

NOTE

AMS playback allows you to play back the files set in the "MP3/WMA Mode" menu (page 16).

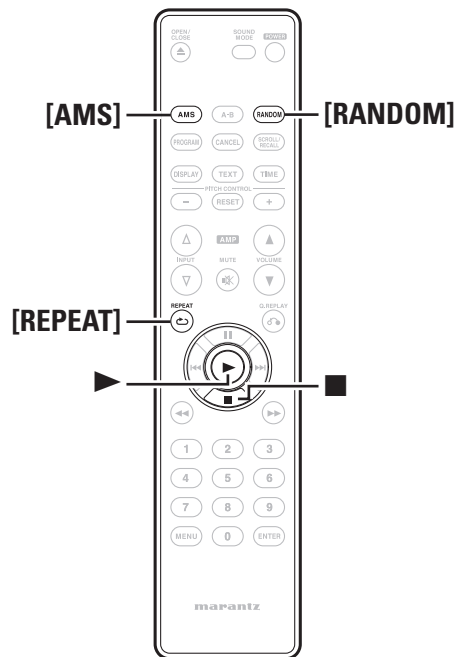

Explanation of terms

B

Bit rate

This expresses the read amount per 1 second of video/audio data recorded in a disc.

M

MP3 (MPEG Audio Layer-3)

This is an internationally standardized audio data compression scheme, using the "MPEG-1" video compression standard. It compresses the data volume to about one eleventh its original size while maintaining sound quality equivalent to a music CD.

S

Sampling frequency

Sampling involves taking a reading of a sound wave (analog signal) at regular intervals and expressing the height of the wave at each reading in digitized format (producing a digital signal).

The number of readings taken in one second is called the "sampling frequency". The larger the value, the closer the reproduced sound is to the original.

W

WMA (Windows Media Audio)

This is audio compression technology developed by Microsoft Corporation.

WMA data can be encoded using Windows Media® Player Ver. 7, 7.1, Windows Media® Player for Windows® XP and Windows Media® Player 9 Series.

To encode WMA files, only use applications authorized by Microsoft Corporation. If you use an unauthorized application, the file may not work properly.

Others

❑ Playing CD-R/CD-RW discs



This unit can play back the CD-RW (ReWritable) discs as well as ordinary Audio CD and CD-R (Recordable) discs.

- This unit can play back Audio CD format and CD-R/CD-RW discs which contain MP3/WMA music data. However, some discs may have problems such as unable to play, noise or sound distortion. For details, please read the instruction manual provided with a CD recorder.
- The CD-R and CD-RW discs should contain properly-recorded TOC information so that they can be played back. In CD recorders, the task of writing TOC information is referred to as finalizing the disc. Discs that are not finalized cannot be properly recognized as an Audio CD and played back by regular CD players and Super Audio CD players. For details, please read the instruction manual provided with a CD recorder.
 - *TOC stands for Table Of Contents and contains information such as the total number of tracks and total playing time of the disc.
- This player can only be used to play Audio CD-DA format discs or discs on which MP3 or WMA audio data have been recorded. Do not attempt to play a disc containing other data, such as a CD-ROM for PCs, on this unit.
- As the playback of a CD-RW disc necessitates partial change of the player setup, it may take longer time for reading the TOC information than when an Audio CD or CD-R disc is played.

❑ Playing MP3 or WMA files

This CD player can be used to play CD-R or CD-RW discs on which MP3 (MPEG Audio Layer-3) or WMA (Windows Media Audio) format audio files have been recorded.

Support for MP3 ID3 tags enables display of ID3 information, such as artist names, album titles, track titles and the like, if this information has been recorded with the tracks.

- Windows Media and the Windows are the registered trademark and trademark of Microsoft Corporation in the United States and other countries.
- Music that you have recorded that is subject to copyright laws is for personal use only, and cannot be used otherwise without the permission of the copyright holder.

NOTE

- The sound file specification supported by this CD player is "MPEG-1 Audio Layer-3" (sampling frequency fs 32 kHz, 44.1 kHz, 48 kHz). Other specifications, such as MPEG-2 Audio Layer-3, MPEG-2.5 Audio Layer-3, MP1 or MP2 are not supported.
- Generally the higher the bit rate, the higher the sound quality. MP3 bit rates are between 32 - 320 kb/s and for WMA between 64 - 160 kb/s. It is recommended that MP3/WMA recordings with a bit rate of at least 128 kb/s be used.
- Ensure that MP3/WMA files have the extension ".mp3" or ".wma." Files with other file extensions or without any extension at all cannot be played on this player.
- Playlists are not supported.
- The maximum number of files supported on a single disc is 255 and the maximum number of folders is also 255.
- File and folder names up to a length of 32 characters can be displayed.
- This player supports MP3 ID3 tags.
- The text information, such as ID3 tag information and file names that are displayed during playback of MP3s, support English alphanumeric characters only.
- When playing variable bit rate files, it is possible that the playing time may not be displayed accurately.
- When writing onto CD-R or CD-RW discs, please use either ISO9660 mode 1 or ISO9660 mode 2-disc format. Multi-session recording is also supported enabling the playing of data that have been added to a disc.
- MP3/WMA files that have been recorded by "packet writing" cannot be played back.
- Depending on the condition of the recorded data, it may take some time to read song information.
- In the case of an Enhanced or Mixed Mode CD having combined audio format CD-DA along with MP3/WMA files, only the CD-DA audio portion will be played.
- The playback of WMA DRM (Digital Rights Management) files is not supported by this player.

Troubleshooting

If a problem occurs, first check the following:

1. Are the connections correct?

2. Is the unit being operated as described in the owner's manual?

If this unit does not operate properly, check the items listed in the table below. If the problem persists there may be a malfunction.

In this case, disconnect the power immediately and contact the retail outlet.

Symptom	Cause	Countermeasure	Page
The disc does not rotate.	• The power cable is not plugged in.	• Plug the power cable into a household power outlet.	7
	• Power of this unit is not turned on.	• Turn on power to the unit.	8
	• The disc is not set correctly.	• Set the disc correctly.	3
	• The disc is placed upside-down. (The label of the disc is facing down.)	• Set the disc correctly.	3
	• The disc is dirty.	• Clean the recording surface of the disc.	4
	• The disc is scratched.	• A disc with many scratches may not be playable.	-
	• The disc is warped.	• A warped disc may not be playable.	-
The disc rotates but there is no sound output.	• The amplifier or speakers are not connected correctly.	• Connect the cables correctly. (Refer to User Guide supplied with the amplifier.)	-
	• Power to the amplifier is not turned on.	• Turn on power to the amplifier. (Refer to User Guide supplied with the amplifier.)	-
	• The function or input source selector switch of the amplifier is not set to "CD" or "AUX" (amplifier terminal to which this unit is connected).	• Set the function or input source selector switch of the amplifier to "CD" or "AUX" (amplifier terminal to which this unit is connected). (Refer to User Guide supplied with the amplifier.)	-
	• The amplifier volume is set to minimum.	• Adjust the amplifier volume. (Refer to User Guide supplied with the amplifier.)	-
The display does not light during playback.	• The Audio EX function ([SOUND MODE]) is set to "Audio EX2".	• Set the Audio EX function ([SOUND MODE]) to "Audio EX OFF" or "Audio EX1".	14

Symptom	Cause	Countermeasure	Page
The disc stops rotating.	• The disc is dirty.	• Clean the recording surface of the disc.	4
	• The disc is scratched.	• A disc with many scratches may not be playable.	-
	• The disc is warped.	• A warped disc may not be playable.	-
	• The disc being played is not a music CD. Or MP3/WMA files are not recorded on the disc.	• A CD-ROM meant for a personal computer cannot be played.	17
The remote control does not operate.	• The distance between the unit and remote control is too great.	• Use the remote control closer to the unit, within operational range.	4
	• There is some object between the unit and remote control.	• Remove the object.	4
	• The batteries in the remote control are expended.	• Replace all batteries with new batteries.	4
	• The remote sensor of the unit is exposed to strong light.	• Avoid exposing the remote sensor to strong light.	4
	• The EXTERNAL/INTERNAL switch of the unit is set to "EXTERNAL".	• To use this unit without an amplifier, set the remote control switch to "INTERNAL".	12
	CD-R/CD-RW disc cannot be played.	• The disc is placed upside-down. (The label of the disc is facing down.)	• Set the disc correctly.
• The recorded data is not written in an audio (CD-DA) format. Or the MP3/WMA files are not recorded correctly.		• Record data that is applicable to this unit.	17
Pitch control operation cannot be performed.	• The Audio EX function ([SOUND MODE]) is not set to "Audio EX OFF".	• Set the Audio EX function ([SOUND MODE]) to "Audio EX OFF".	14
Digital audio signals are not output.	• The "Digital Out" setting is set to "Off".	• Set the "Digital Out" setting to "On".	16
	• The Audio EX function ([SOUND MODE]) is set to "Audio EX2".	• Set the Audio EX function ([SOUND MODE]) to "Audio EX1".	14
	• The Audio EX function ([SOUND MODE]) is set to "Audio EX OFF" and pitch control is used.	• Set the pitch control "Pitch: 0". • Or, set the Audio EX function ([SOUND MODE]) to "Audio EX1".	14

Specifications

Audio characteristics

- **Channels:** 2 channels
- **Frequency response:** 2 Hz to 20 kHz
- **Dynamic range:** 100 dB
- **Signal-to-noise ratio:** 110 dB
- **Channel separation:** 110 dB (1 kHz)
- **Harmonic distortion:** 0.002% (1 kHz)
- **Wow & flutter:** Precision of quartz
- **Audio output:** 2.25 V rms, stereo
- **Headphone output:** 18 mW/32 ohms (variable maximum)
- **Digital output**
- **Coaxial output (pin jack):** 0.5 Vp-p, 75 ohms
- **Optical output (square optical connector):** -19 dBm

Optical readout system

- **Laser:** AlGaAs semiconductor
- **Wavelength:** 780 nm

Signal system

- **Sampling frequency:** 44.1 kHz
- **Quantization:** 16-bit linear PCM

Power supply

- **N version:** AC 120 V 60 Hz
- **Power consumption:** 14 W
- **Standby power consumption:** 0.4 W

Cabinet, etc.

- **Accessories**
- **Remote controller:** 1
- **AAA batteries:** 2
- **AC power cord:** 1
- **Audio connecting cord:** 1
- **Remote control connecting cord:** 1
- **Maximum outer dimensions**
- **Width:** 17-3/8 inches (440mm)
- **Height:** 4-3/16 inches (105mm)
- **Depth:** 13-7/16 inches (340mm)
- **Weight:** 5.1kg
- **Allowable operating temperature:** +5 to +35°C
- **Allowable operating humidity:** 5 to 90% (no condensation)

For purposes of improvement, specifications and design are subject to change without notice.

Index

☞ Numerics

1-track repeat 10, 18

☞ A

A-B Repeat 10, 18
 All-track repeat 10, 18
 AMS play 11, 19
 Analog connections 7
 Audio cable 7
 Auto standby mode 16

☞ B

Batteries 4

☞ C

CD-R/CD-RW 3
 CD-Text 9
 Coaxial digital cable 12
 Connections

- Analog connections 7
- Coaxial digital connections 12
- Connecting cables 7, 12
- Connecting the power cord 7
- Digital connections 12
- Optical digital connections 12

Cont. mode 16

☞ D

Delete program playback 13
 Digital audio output setting 16
 Display 5

☞ E

Edit 15
 EXTERNAL 12

☞ F

Fast-forwarding 8, 18
 Fast-reversing 8, 18
 File playback mode setting 16
 Finalise 3
 Folder mode 16

☞ I

INTERNAL 12

☞ M

MP3 18
 Music CDs 3

☞ O

Optical cable 12

☞ P

Peak level search 15
 Pitch control function 14
 Playback

- Playback CDs 8
- Program playback 13
- Random playback 11, 19
- Repeat playback 10, 18
- Stopping playback 8, 18
- Stopping playback temporarily 8, 18

Power cord 7
 Program playback 13

☞ Q

Quick replay playback 16

☞ R

Random playback 11, 19
 Remote control 6

- Inserting the batteries 4
- Remote control connection 12
- Repeat playback 10, 18

☞ S

Searching 8, 18
 Skipping 9
 Stopping playback 8, 18

☞ T

Text information 9, 18

☞ W

WMA 18



• CD5004 (unit: inch(mm))

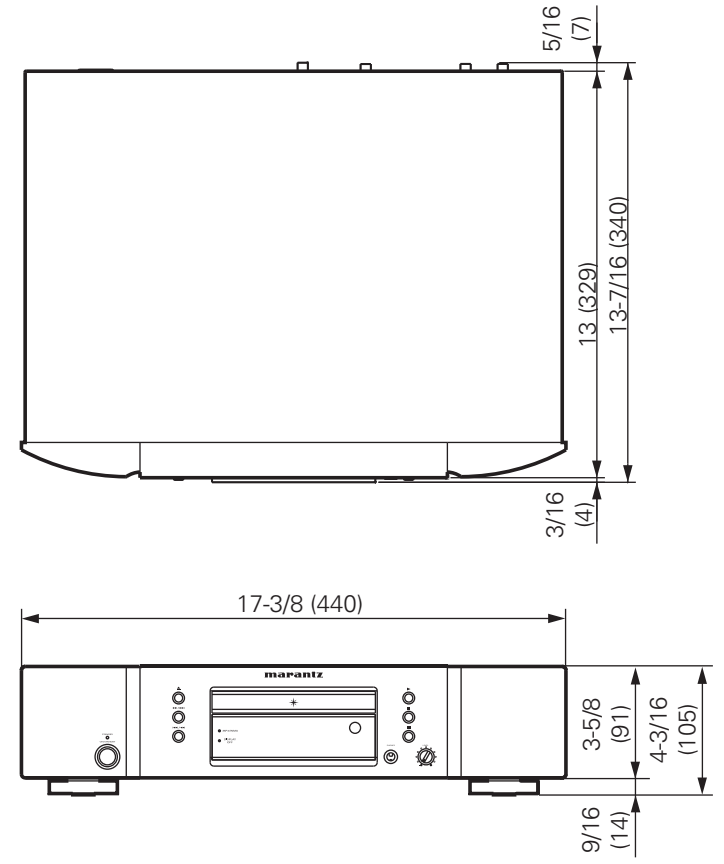

www.marantz.com

You can find your nearest authorized distributor or dealer on our website.

marantz[®] is a registered trademark.