

# marantz®

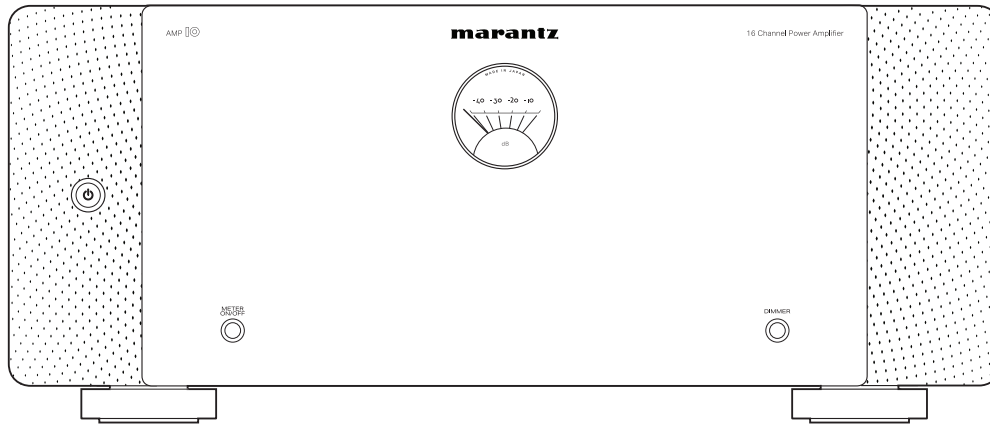

AMP |  | Power Amplifier

Owner's Manual

<b>Accessories</b>	<b>5</b>
<b>Features</b>	<b>6</b>
High quality sound	6
High performance	6
<b>Part names and functions</b>	<b>7</b>
Front panel	7
Rear panel	9

## Connections

<b>Preparations</b>	<b>13</b>
Speakers	13
Preamplifier	15
<b>Example connection variation</b>	<b>16</b>
<b>Connecting a Preamplifier</b>	<b>17</b>
Example of connections to Marantz AV 10 Preamplifier	17
Bi-amp connection	19
BTL connection	20
<b>Connecting an external control device</b>	<b>21</b>
AMP CONTROL jacks	21
REMOTE CONTROL jacks	22
FLASHER IN jack	23
DC CONTROL jacks	24
<b>Setting the auto standby function</b>	<b>26</b>
<b>Connecting the power cord</b>	<b>27</b>



## Playback

<b>Basic operation</b>	<b>29</b>
Turning the power on	29
Turning the power standby	29
<b>Turning the level meter display on or off</b>	<b>30</b>
<b>Changing the brightness of the illumination</b>	<b>31</b>

## Tips

<b>Troubleshooting</b>	<b>32</b>
Power does not turn on / Power is turned off	33
No sound comes out	34



<a href="#">Resetting to the default values</a>	<a href="#">35</a>
---	--------------------

## Appendix

---

<a href="#">Explanation of terms</a>	<a href="#">36</a>
--------------------------------------	--------------------

## Specifications

---

<a href="#">Specifications</a>	<a href="#">37</a>
--------------------------------	--------------------

<a href="#">Index</a>	<a href="#">39</a>
-----------------------	--------------------





Thank you for purchasing this Marantz product.

To ensure proper operation, please read this owner's manual carefully before using the product.

After reading this manual, be sure to keep it for future reference.

## Accessories

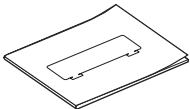
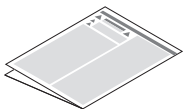
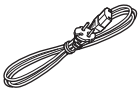
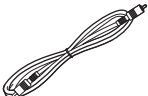
Check that the following parts are supplied with the product.

 <p>Quick Start Guide</p>	 <p>Safety Instructions</p>	 <p>Power cord</p>	 <p>Remote control connector cable</p>	 <p>AMP control connector cable</p>
 <p>Speaker terminal wrench</p>				



# Features

## High quality sound

- **16-channel switching power amplifier module**

A switching power amplifier is used to achieve a high output of 200W per channel (8Ω, 1kHz, T.H.D.: 0.05%, 2-channel operation). To ensure excellent performance, minimal distortion occurs across all frequencies. Additionally, there is little change in frequency characteristics due to speaker impedance. This system is combined with a high-speed preamplifier circuit with an HDAM for accurate reproduction of the fine nuances of DSD and high-resolution audio sources.

- **Current feedback amplifier**

This unit has a high-speed current feedback amplifier circuit for accurate amplification of signals from HD audio devices such as Blu-ray disc players. The high-speed current feedback amplifier also achieves natural sound field reproduction.

- **High audio quality parts**

Each part of the circuit is designed to ensure high audio quality, including high audio quality MELF resistance and an electrolytic capacitor.

- **Double-layered chassis**

- **High-end machined brass speaker jacks**

## High performance

- **Switch between UNBALANCED RCA and BALANCED XLR**

You can choose between two input channels: UNBALANCED RCA input or BALANCED XLR input.

- **BI-AMP/BTL connection setting function**

You can set a bi-amp connection and BTL connection for the power amplifier of each of the two channels without needing to connect an additional cable from the preamplifier.

The BI-AMP connection prevents interference from counter-electromotive force as the woofer and tweeter are powered by separate power amplifiers. The BTL (Bridge) connection achieves a high drive performance as the positive and negative terminals of the speakers are directly powered according to the output levels of the power amplifier. Additionally, the drive current of the speakers does not directly enter the ground circuit. This stabilizes the ground potential that the amplitude is based on, reducing noise and interference between circuits to achieve an accurate amplitude.

- **AMP CONTROL function**

By connecting this unit to a Marantz AV 10 Preamplifier with an AMP CONTROL jack using the included cable, you can control operation of both units simultaneously, such as controlling the power or the illumination display settings. The connection to the AV 10 is a ground floating connection that does not create an earth loop, minimizing adverse impacts on audio quality.

- **Other Functions**

Equipped with IR flash input that supports custom installations, and DC trigger input and output terminals.



## Part names and functions

### Front panel

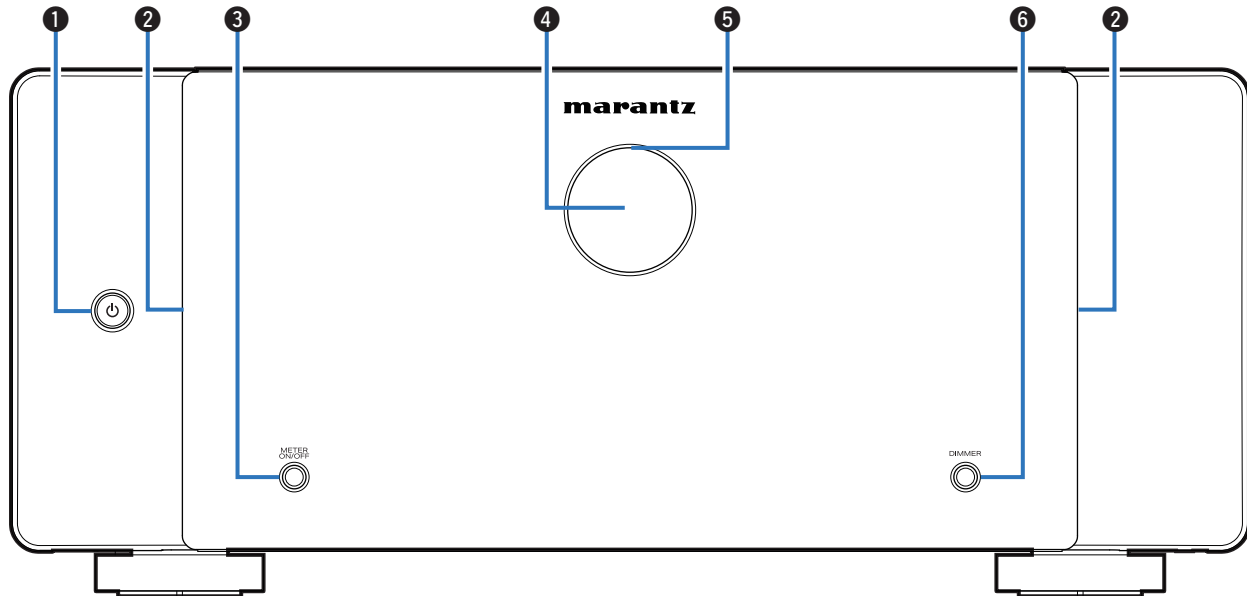

For details, see the next page.

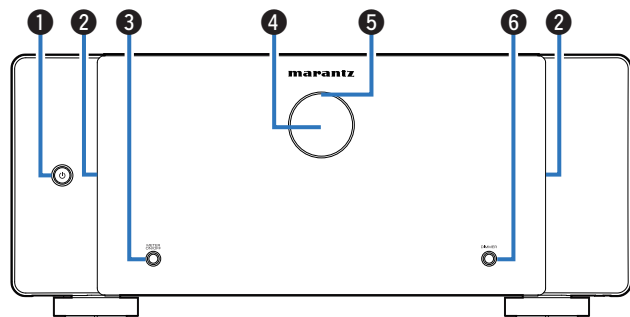

**1 Power operation button (⏻)**

Used to turn the power on/off (standby). (👉 p. 29)

**2 Illumination**

Lit when the power is turned on. The brightness of the illumination can be changed by pressing DIMMER.

**3 METER ON/OFF button**

Turns the level meter display and meter lighting on or off. (👉 p. 30)

**4 Level meter**

Displays the level of the signal input through channel 1. This can be turned off by pressing METER ON/OFF.

**5 Protection circuit indicator**

This blinks when the protection circuit has operated. (👉 p. 33)

**6 DIMMER button**

Press this button to change the brightness of the illumination. (👉 p. 31)





## Rear panel

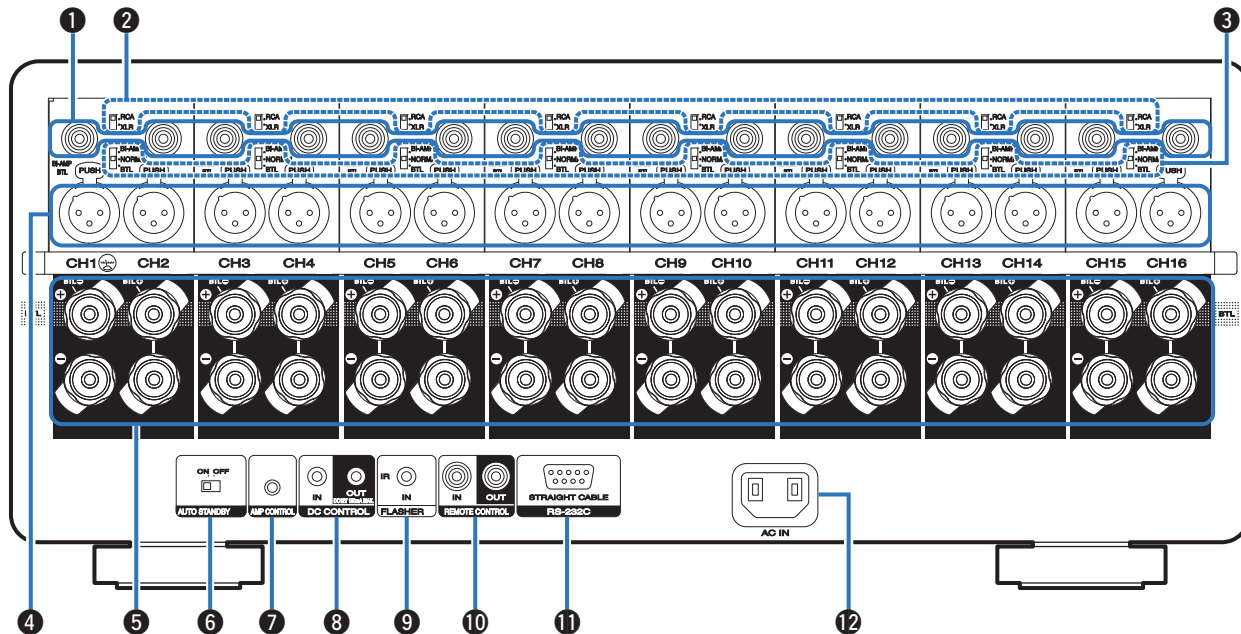

For details, see the next page.



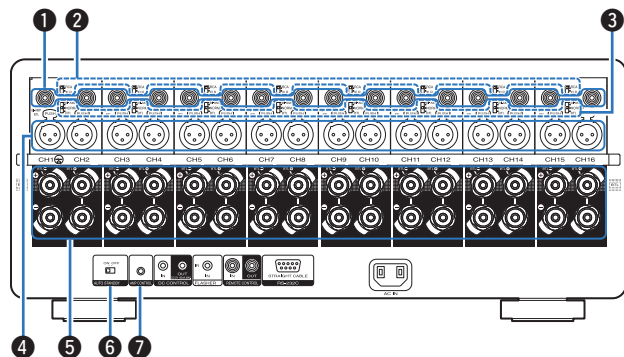

**1 UNBALANCED RCA INPUT connectors**

Used to connect a preamplifier with UNBALANCED RCA output connectors.

**2 RCA/XLR INPUT selector**

Switches according to the jack used for connecting to the preamplifier (UNBALANCED RCA or BALANCED XLR).

**3 NORMAL/BI-AMP/BTL selector**

You can set a bi-amp connection and BTL connection for the power amplifier of each of the two channels.

**4 BALANCED XLR INPUT connectors**

Used to connect a preamplifier with BALANCED XLR output connectors.

**5 Speaker terminals (SPEAKERS)**

Used to connect speakers. (👉 p. 17)

**6 AUTO STANDBY selector**

When the auto standby function is set to “ON”, the power of this unit automatically enters standby after 15 minutes of no input signal and no operations. (👉 p. 26)

**7 AMP CONTROL jacks**

Use these to connect to a Marantz preamplifier with AMP CONTROL jacks. This enables operations to be performed simultaneously on this unit and the preamplifier, such as turning the power on or placing it on standby and adjusting the brightness of the illumination. (👉 p. 21)



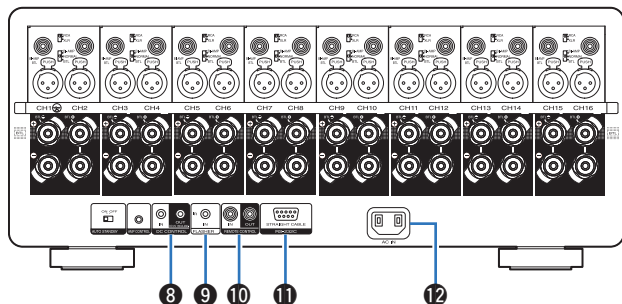

### 8 DC CONTROL jacks

Used to connect devices equipped with the trigger function. (☞ p. 24)

### 9 FLASHER IN jack

Used to connect commercially available (sold separately) IR repeaters. (☞ p. 23)

### 10 REMOTE CONTROL jacks

Used to connect a Marantz product that is equipped with REMOTE CONTROL terminals. Use this when you want to control this unit with a remote control. (☞ p. 22)

### 11 RS-232C connector

Used to connect home automation controller devices fitted with RS-232C connectors. Consult the owner's manual of the home automation controller for more information about serial control of this unit.

Perform the operation below beforehand.

- ① Turn on the power of this unit.
- ② Turn off the power of this unit from the external controller.
- ③ Check that the unit is in the standby mode.

### 12 AC inlet (AC IN)

Used to connect the power cord. (☞ p. 27)

#### NOTE

- Do not touch the inner pins of the connectors on the rear panel. Electrostatic discharge may cause permanent damage to the unit.



## ■ Contents

Preparations	13
Example connection variation	16
Connecting a Preamplifier	17
Connecting an external control device	21
Setting the auto standby function	26
Connecting the power cord	27

### NOTE

- Do not plug in the power cord until all connections have been completed.
- Do not bundle power cords together with connection cables. Doing so can result in noise.

## ■ Cables used for connections

Provide necessary cables according to the devices you want to connect.

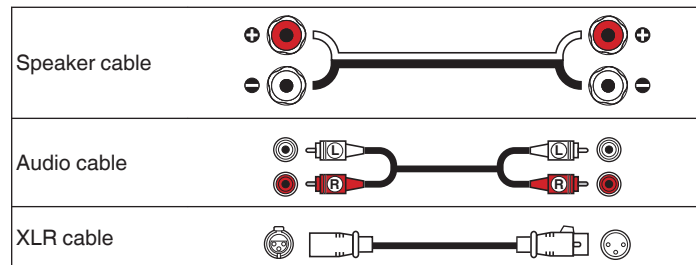

# Preparations

## Speakers

This section explains how to connect them using typical examples.

### NOTE

- Disconnect this unit's power plug from the power outlet before connecting the speakers.
- Connect so that the speaker cable core wires do not protrude from the speaker terminal. The protection circuit may be activated if the core wires touch the rear panel or if the + and - sides touch each other. ("Protection circuit" (☞ p. 36))
- Never touch the speaker terminals while the power supply is connected. Doing so could result in electric shock.
- Use speakers with an impedance of 4 – 16  $\Omega$ /ohms.

### ■ Connecting the speaker cables

Carefully check the left (L) and right (R) channels and + (red) and – (black) polarities on the speakers being connected to this unit, and be sure to connect the channels and polarities correctly.

- 1 Peel off about 15 mm of sheathing from the tip of the speaker cable, then either twist the core wire tightly or terminate it.**



- 2 Attach the included speaker terminal wrench to the speaker terminal.**

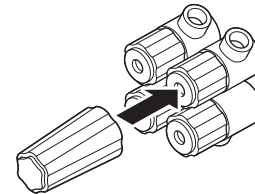

**3** Turn the speaker terminal counterclockwise to loosen it.

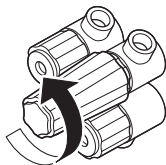

**4** Insert the speaker cable's core wire to the hilt into the speaker terminal.

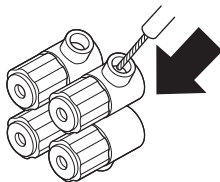

**5** Turn the speaker terminal clockwise to tighten it.

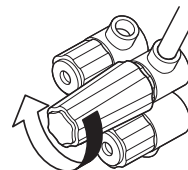

- The speaker terminal wrench contains a built-in magnet that enables it to be attached to the rear panel. After connecting speakers, store it in the included accessory box or in another safe place.

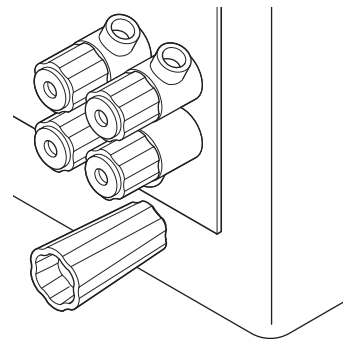

## Preamplifier

- Connect one end of the cable to the input terminals of this unit and the other end to the output terminals of the preamplifier (sold separately).
- This unit has UNBALANCED RCA connectors and BALANCED XLR connectors. Select the appropriate connectors for the preamplifier you will use and change the setting of the RCA or XLR selector on this unit. If the preamplifier has both types of connectors, either type can be used.

### [XLR connector PIN arrangement]

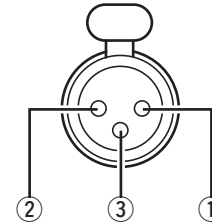

- ① GND (Ground)
- ② HOT (Hot)
- ③ COLD (Cold)

The PIN arrangement in this unit uses the European method.

In the USA method, ② is COLD, and ③ is HOT.

When connecting a device that utilizes the USA type of PIN arrangement, replace the ② and ③ plugs on one side of the balanced cable.

#### NOTE

- Do not short the HOT and GND or COLD and GND for use.
- Remove the power plug of this unit from the outlet before connecting the preamplifier. Turn off the power of the device being connected as well.



# Example connection variation

[Example 1] AV10

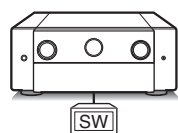

This unit

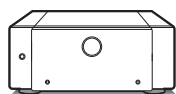

FL C FR SL SR SBL SBR



7.1ch connection

[Example 2] AV10

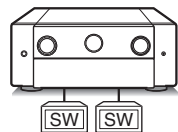

This unit

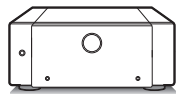

FL C FR SL SR SBL SBR  
FWL FWR FHL FHR RHL RHR TML TMR



15.2ch connection

[Example 3] AV10

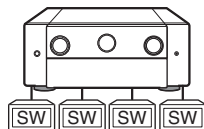

This unit

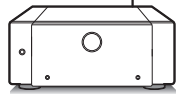

This unit

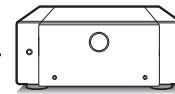

FL C FR SL SR SBL SBR  
FWL FWR FHL FHR RHL RHR TML TMR  
CH TS  
Z2L Z2R Z3L Z3R



17.4ch connection  
+  
ZONE2 connection  
or  
ZONE3 connection

**FL** Front speaker (L)

**FR** Front speaker (R)

**C** Center speaker

**SL** Surround speaker (L)

**SR** Surround speaker (R)

**SW** Subwoofer

**SBL** Surround back speaker (L)

**SBR** Surround back speaker (R)

**FWL** Front wide speaker (L)

**FWR** Front wide speaker (R)

**FHL** Front height speaker (L)

**FHR** Front height speaker (R)

**RHL** Rear height speaker (L)

**RHR** Rear height speaker (R)

**TML** Top middle speaker (L)

**TMR** Top middle speaker (R)

**CH** Center height speaker

**TS** Top surround speaker

**Z2L** ZONE2 speaker (L)

**Z2R** ZONE2 speaker (R)

**Z3L** ZONE3 speaker (L)

**Z3R** ZONE3 speaker (R)





# Connecting a Preamplifier

## Example of connections to Marantz AV 10 Preamplifier

### ■ Connecting the UNBALANCED RCA PRE OUT connector

If using the UNBALANCED RCA connectors, switch the RCA/XLR INPUT selector setting to "RCA". Set the NORMAL/BI-AMP/BTL selector to "NORMAL".

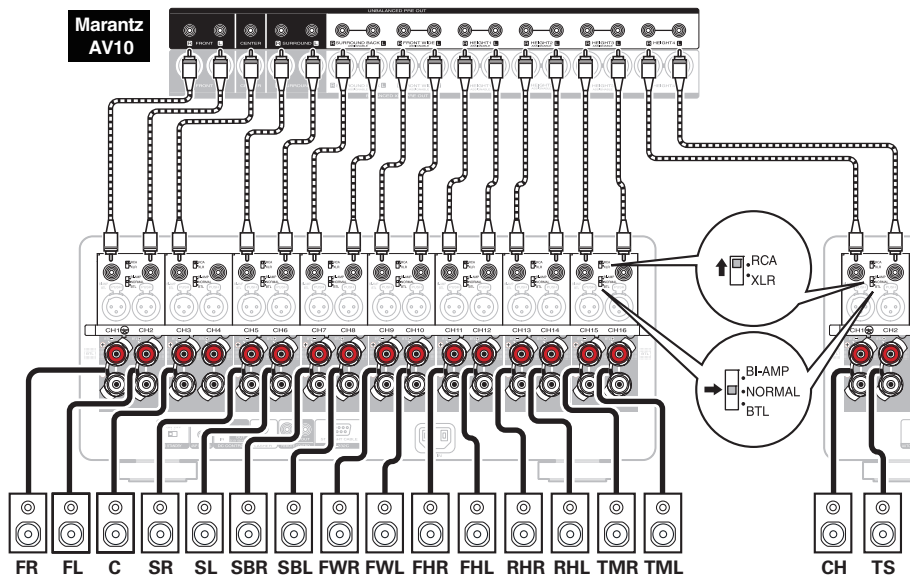

**NOTE**

- Be sure to configure the RCA/XLR INPUT selector and NORMAL/BI-AMP/BTL selector settings before turning the power on. If you try to change these settings after turning the power on, the settings will not change.



## ■ Connecting the BALANCED XLR PRE OUT connector

If using the BALANCED XLR connectors, switch the RCA/XLR INPUT selector setting of this unit to “XLR”. Set the NORMAL/BI-AMP/BTL selector to “NORMAL”.

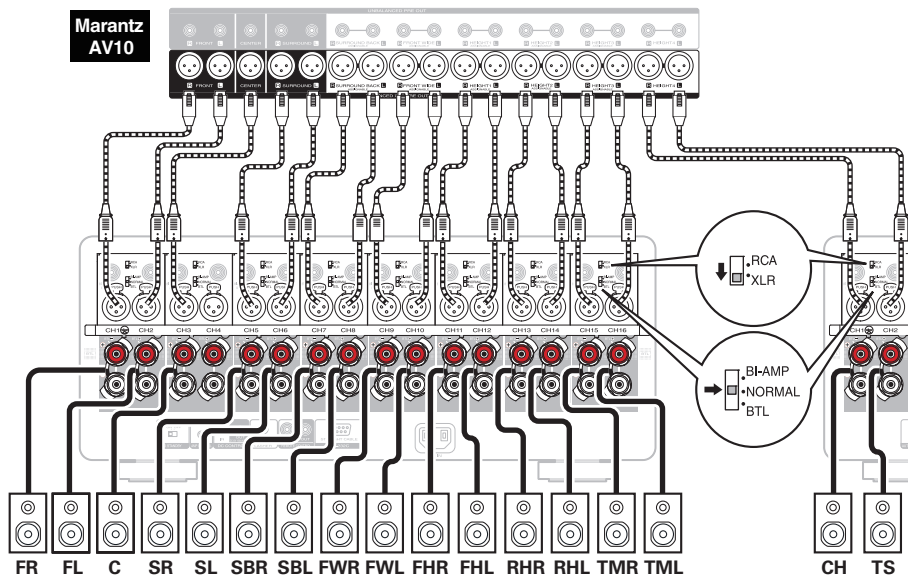

### NOTE

- Be sure to configure the RCA/XLR INPUT selector and NORMAL/BI-AMP/BTL selector settings before turning the power on. If you try to change these settings after turning the power on, the settings will not change.



## Bi-amp connection

Bi-amp connection is a method to connect separate amplifiers to the tweeter terminal and woofer terminal of a speaker that supports bi-amplification. This connection enables back EMF (power returned without being output) from the woofer to flow into the tweeter without affecting the sound quality, producing a higher sound quality.

### Example: Using channels 1 and 2 as a bi-amp

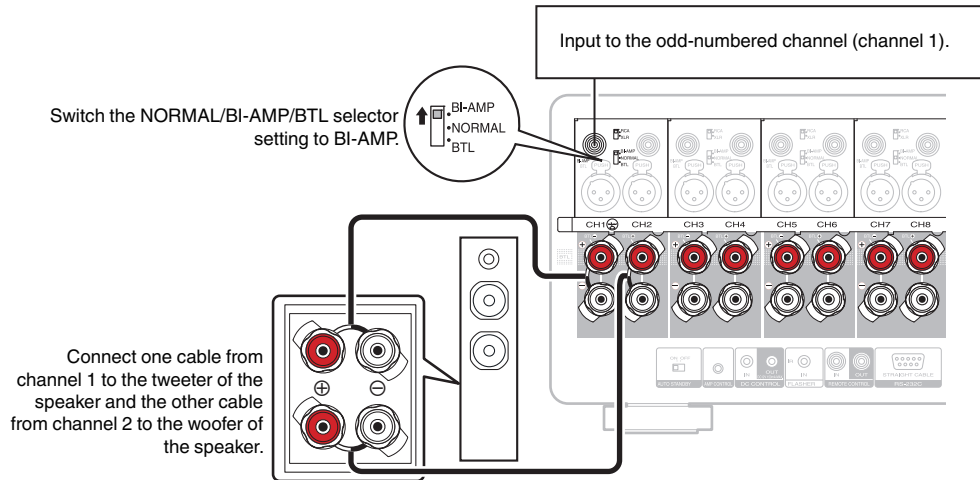

#### NOTE

- When making bi-amp connections, be sure to remove the short-circuiting plate or wire between the speaker's woofer and tweeter terminals.
- Be sure to configure the and NORMAL/BI-AMP/BTL selector setting before turning the power on. If you try to change these settings after turning the power on, the settings will not be applied.



## BTL connection

A BTL connection uses two channels to power one speaker. Two power amplifiers are used to output antiphase signals from one input signal, achieving powerful audio reproduction.

**Example: Using channels 1 and 2 for a BTL connection**

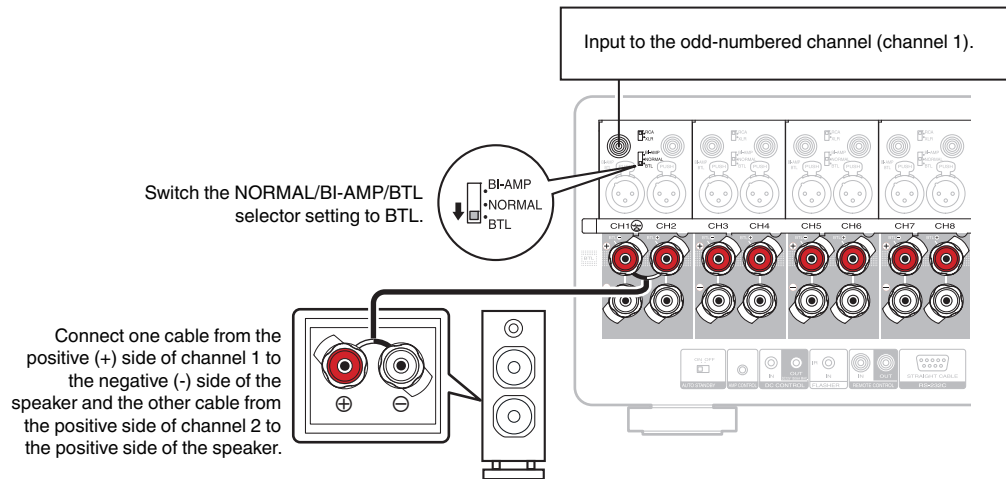

### NOTE

- Be sure to configure the and NORMAL/BI-AMP/BTL selector setting before turning the power on. If you try to change these settings after turning the power on, the settings will not be applied.



# Connecting an external control device

## AMP CONTROL jacks

You can connect this unit to a Marantz AV 10 Preamplifier with an AMP CONTROL jack using the included control cable and perform the following operations for both units simultaneously.

- When the power of the preamplifier is turned on or placed on standby, the power of this unit is turned on or placed on standby too.
- When the brightness of the preamplifier's display is adjusted, the same setting is applied to the illumination of this unit

[Example] AV10

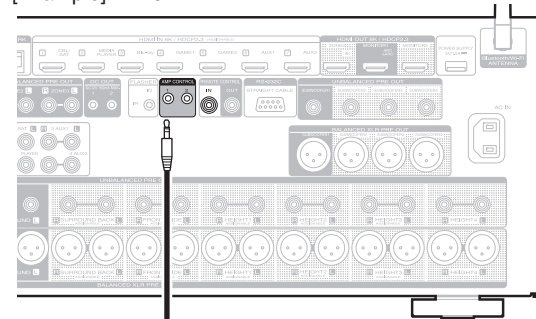

This unit

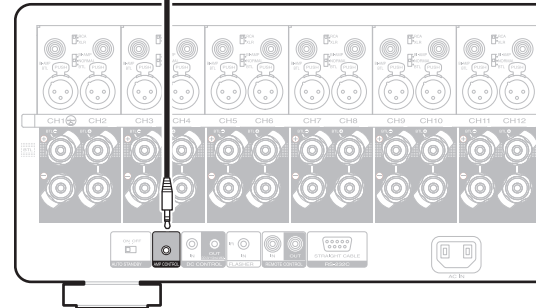

## REMOTE CONTROL jacks

When connecting a Marantz AV 10 Preamplifier, you can switch the power of this unit to ON/STANDBY together with the AV 10 power supply. For details, see the AV 10 owner's manual.

[Example] AV10

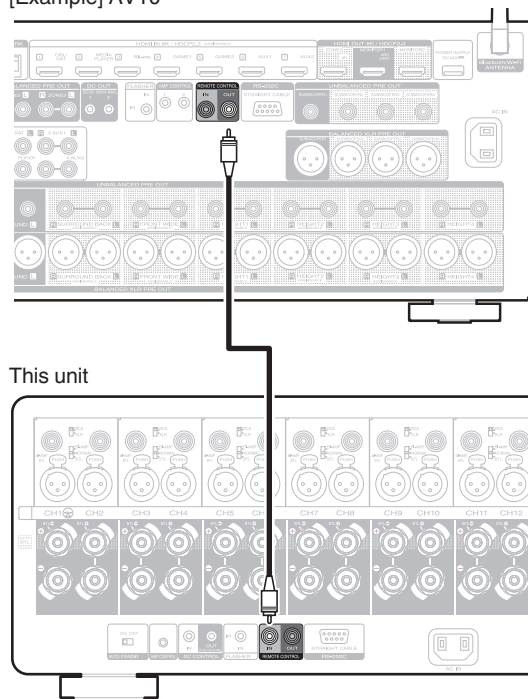

## FLASHER IN jack

If a commercially available (sold separately) IR repeater is connected to the FLASHER IN jack of this unit, remote control operations can be performed even if this unit is installed in a place where the remote control signal may not reach, such as in a cabinet.

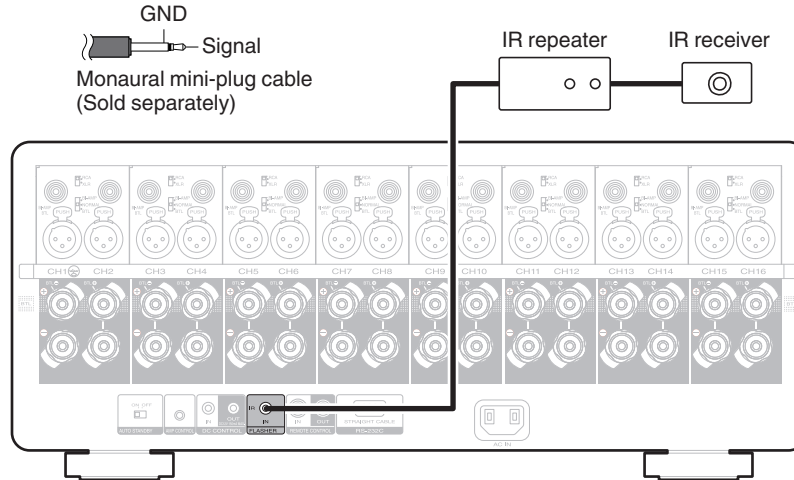

## DC CONTROL jacks

### ■ DC CONTROL OUT jack

When a device with DC CONTROL IN jack is connected, the connected device's power on/standby can be controlled through linked operation to this unit.

The DC CONTROL OUT jack outputs a maximum 12 V DC/150 mA electrical signal.

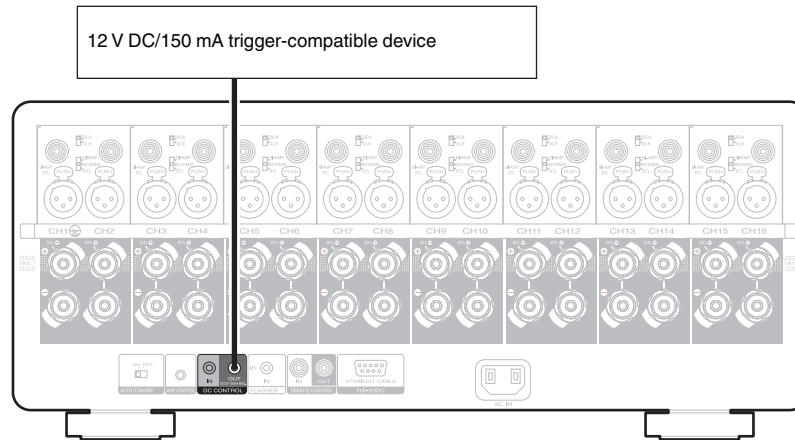

#### NOTE

- Use a monaural mini-plug cable for connecting the DC OUT jacks. Do not use a stereo mini-plug cable.
- If the permissible trigger input level for the connected device is larger than 12 V DC/150 mA, or has shorted, the DC OUT jack cannot be used. In this case, turn off the power to the unit, and disconnect it.





## ■ DC CONTROL IN jack

Used when connecting a unit that has a DC CONTROL OUT jack to this device, and linking the power ON/STANDBY of the connected device with the power ON/STANDBY of this unit.

For details, see the instruction manual of the connected device.

### NOTE

- When a 5 V – 15 V voltage is input to the DC CONTROL IN jack, the power of this unit switches ON. However, inputting voltage outside of this range will cause damage to this unit.

[Example] AV10

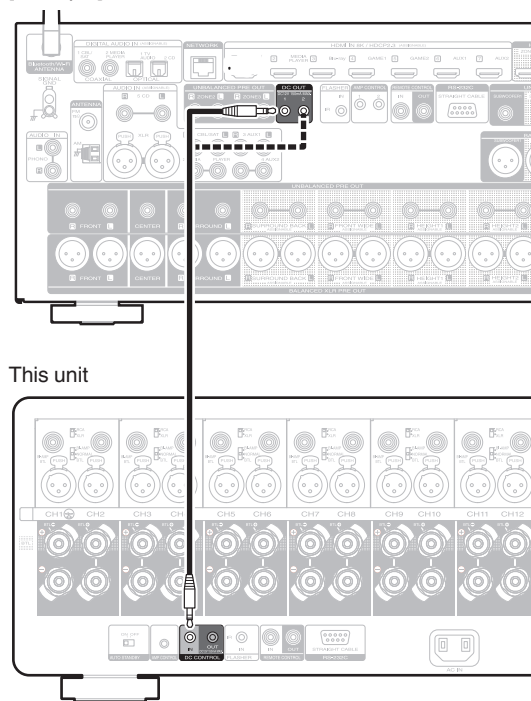

## Setting the auto standby function

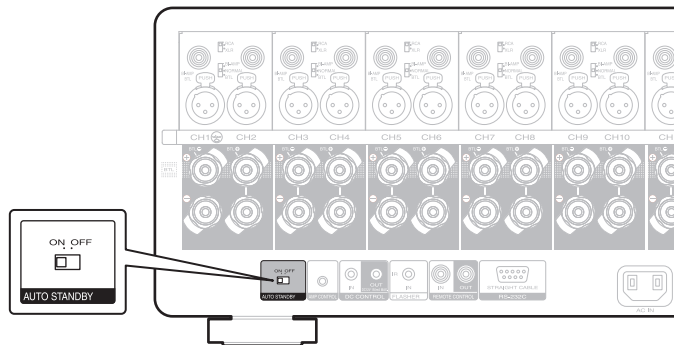

When the auto standby function is set to “ON”, the power of this unit automatically enters standby after 15 minutes of no input signal and no operations.

To use the auto standby function, set the AUTO STANDBY selector to “ON”.

The factory setting is “ON”.



## Connecting the power cord

After completing all the connections, insert the power plug into the power outlet.

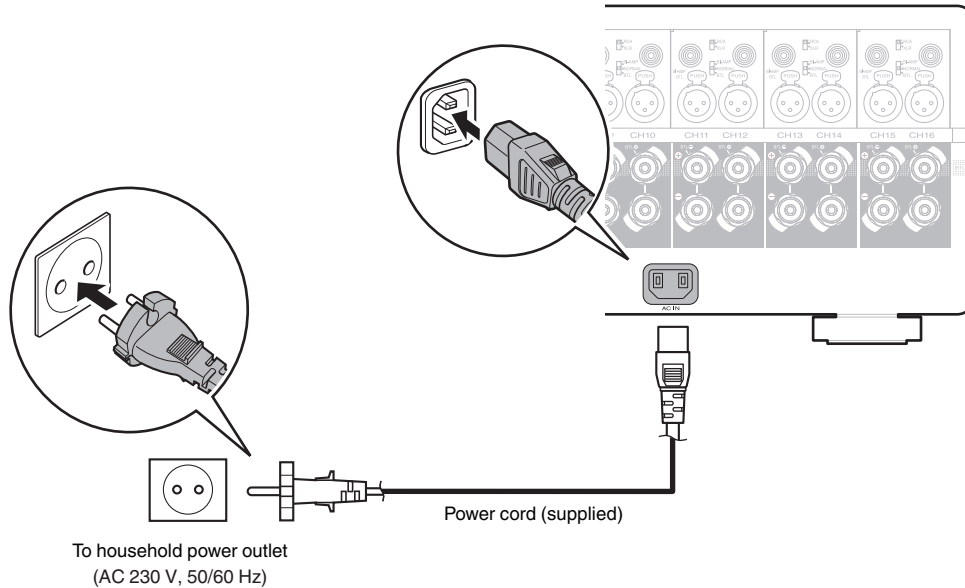

## ■ Contents

### Basic operation

---

Turning the power on	29
Turning the power standby	29

### Convenience functions

---

Turning the meter display off	30
Changing the brightness of the illumination	31



## Basic operation

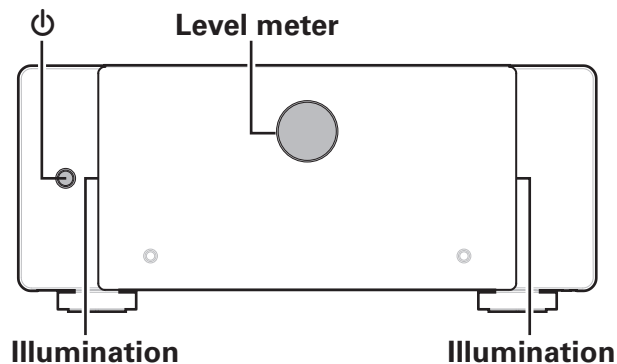

### Turning the power on

#### 1 Press to turn on power to the unit.

The level meter and illumination are lit.

#### NOTE

- When turning the power ON, turn the volume control of connected devices down to the minimum.

### Turning the power standby

#### 1 Press .

The unit switches to standby mode.

#### NOTE

- Even if the unit is switched to standby, some of the circuits are still active. If you will not be using this unit for a prolonged period (due to a holiday etc), remove the power plug from the wall socket. Furthermore, to prevent unexpected accidents, make sure the power plug is located where it can be removed at any time.



- You can connect this unit to a Marantz AV 10 Preamp with an AMP CONTROL jack using the included cable and perform operations for both units simultaneously, such as turning the power on or off. (☞ p. 21)



## Turning the level meter display on or off

When the power of this unit is on, the backlight is lit and the level is displayed according to the channel 1 signal input. The meter display can be turned off when you need darkness, such as when sleeping.

The factory setting is “On”.

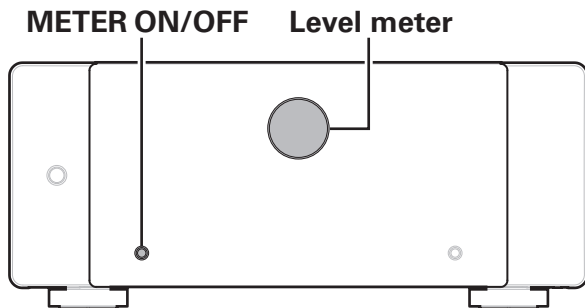

### 1 Press METER ON/OFF.

This button toggles the level meter display on and off.



## Changing the brightness of the illumination

The brightness of the illumination can be adjusted between four levels. Setting the illumination to off reduces noise that could affect playback, achieving high audio quality.

The factory setting is the brightest illumination level.

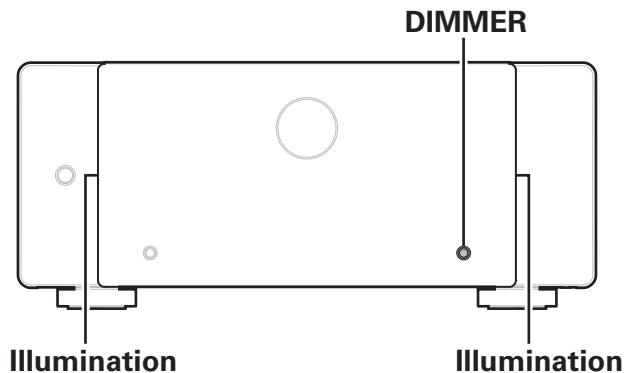

### 1 Press DIMMER.

- This button toggles through the illumination brightness levels.



## Troubleshooting

---

If a problem should arise, first check the following:

1. **Are the connections correct?**
2. **Is the set being operated as described in the owner's manual?**
3. **Are the other devices operating properly?**

If this unit does not operate properly, check the corresponding symptoms in this section.

If the symptoms do not match any of those described here, consult your dealer as it could be due to a fault in this unit. In this case, disconnect the power immediately and contact the store where you purchased this unit.





## Power does not turn on / Power is turned off

### Power does not turn on.

- Check whether the power plug is correctly inserted into the power outlet. (👉 p. 27)

### Power automatically turns off.

- The auto standby function is set to "ON". The unit enters standby after 15 minutes of no operation or input signal. To turn off the auto standby function, set the AUTO STANDBY selector to OFF. (👉 p. 26)

### The unit immediately turns off when the power is turned on.

- The protection circuit has been activated. Unplug the unit from the power outlet, leave it for at least 1 minute and then plug it back in. (👉 p. 36)

### The power turns off and the protection circuit indicator shows one long blink and four short blinks in orange.

- The protection circuit has been activated due to a rise in temperature within this unit. Turn the power off, wait about an hour until this unit cools down sufficiently, and then turn the power on again. (👉 p. 36)
- Please re-install this unit in a place having good ventilation.
- Use speakers that have the specified impedance. (👉 p. 13)
- Check the speaker connections. The protection circuit may have been activated because speaker cable core wires came in contact with each other or a core wire was disconnected from the connector and came in contact with the rear panel of this unit. After unplugging the power cord, take corrective action such as firmly re-twisting the core wire or taking care of the connector, and then reconnect the wire. (👉 p. 13)
- Turn the volume down on the amp connected to this unit, and insert the power plug again.

### The power turns off and the protection circuit indicator shows one long blink and five short blink in orange

- The protective circuit has operated. In this case, remove the power plug from the wall socket, re-examine the installation conditions of this unit, and check the speaker cable connections. If the same situation occurs when the power is switched on again, contact the Marantz Service Center.



## No sound comes out

### No sound comes out of speakers.

- Check the speaker connections and connections to the other devices. (👉 p. 17)
- Alter the input selector to match the input connector (BALANCED or UNBALANCED) of the connected device. (👉 p. 17)
- Insert connection cables all the way in.
- Check that input connectors and output connectors are not reversely connected.
- Check cables for damage.
- Check that speaker cables are properly connected. Check that cable core wires come in contact with the metal part on speaker terminals. (👉 p. 13)
- Securely tighten the speaker terminals. Check speaker terminals for looseness. (👉 p. 13)



## Resetting to the default values

If the unit cannot be operated, restarting the unit may improve the problem. We recommend restarting the unit before returning the settings to the default settings.

If the operations are not improved by restarting the unit, follow the steps below.

Various settings are reset to the factory default values. Make settings again.

### METER ON/OFF

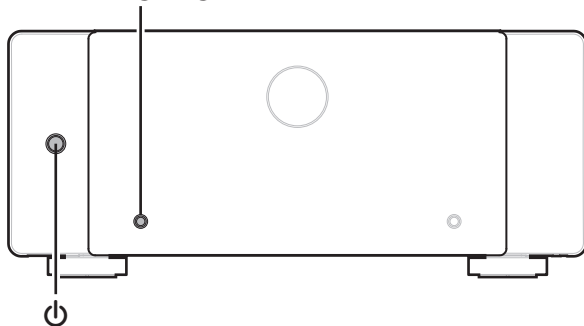

- 1 Turn off the power using  $\text{⏻}$ .**
- 2 Press  $\text{⏻}$  while pressing and holding METER ON/OFF.**  
The Illumination and LEDs continue to blink while the button is being held down.



## Explanation of terms

---

### **Speaker impedance**

This is certain-rated resistance of the speaker set to an alternating current and expressed in ohms.

The smaller the impedance, the greater the output.

However, load on the amplifier is increased. Use speakers whose impedance is supported by this unit.

### **Protection circuit**

This is a function to prevent damage to devices within the power supply when an abnormality such as an overload, excess voltage occurs or over temperature for any reason.



# Specifications

---

<b>Rated output:</b>	Normal, BI-AMP 200 W x 2 (8 $\Omega$ /ohms load, 1kHz, T.H.D. 0.05 %) 400 W x 2 (4 $\Omega$ /ohms load, 1kHz, T.H.D. 0.7 %) BTL 400 W x 2 (8 $\Omega$ /ohms load, 1kHz, T.H.D. 0.05 %)
<b>Output connectors:</b>	4 – 16 $\Omega$ /ohms (Normal, BI-AMP) 8 – 16 $\Omega$ /ohms (BTL)
<b>Frequency response</b> (1 W, 8 $\Omega$ ):	5 Hz – 70 kHz $\pm$ 3 dB
<b>Input sensitivity/impedance:</b>	1.4 V / 47 k $\Omega$ /kohms (UNBALANCED) 2.8 V / 100 k $\Omega$ /kohms (BALANCED)
<b>Signal-to-noise ratio</b> (IHF-A):	110 dB
<b>Voltage amplification level:</b>	29 dB
<b>Operating temperature:</b>	5 °C - 35 °C
<b>Power supply:</b>	AC 230 V, 50/60 Hz
<b>Power consumption:</b>	500 W
<b>Power consumption in standby mode:</b>	0.2 W

For purposes of improvement, specifications and design are subject to change without notice.



■ Dimensions (Unit : mm)

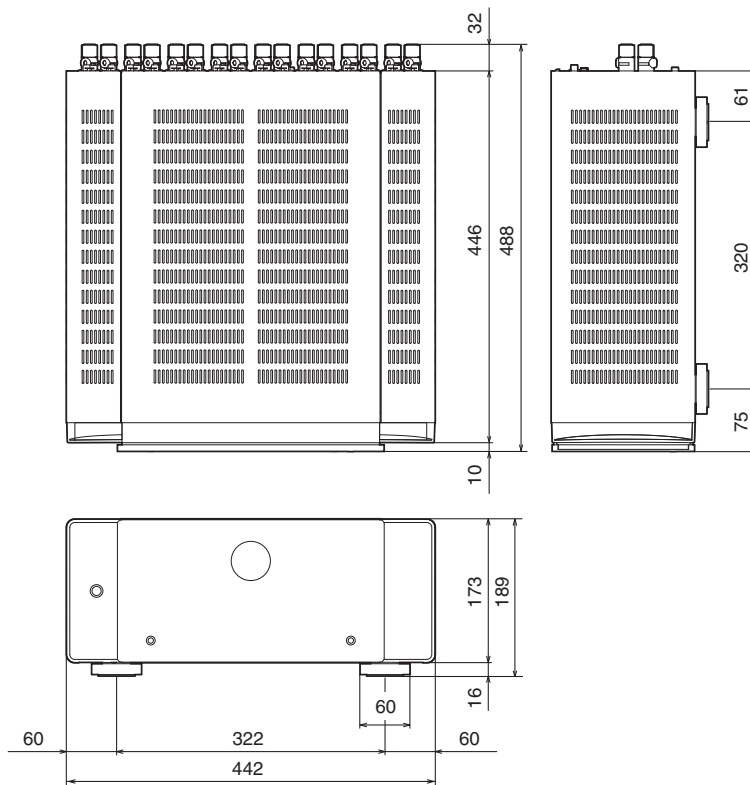

■ Weight : 19.8 kg



# Index

## Numerics

15.2-channel .....	16
17.4-channel .....	16
7.1-channel .....	16

## A

AMP CONTROL .....	21
Auto Standby .....	26

## B

Bi-amp .....	19
BTL .....	20

## F

Front panel .....	7
-------------------	---

## I

Illumination .....	31
--------------------	----

## L

Level meter .....	30
-------------------	----

## P

Protection circuit .....	36
--------------------------	----

## R

Rear panel .....	9
------------------	---

## T

Troubleshooting .....	32
-----------------------	----

## Z

ZONE2/ZONE3 .....	16
-------------------	----



**marantz®**

3520 10846 00AMA

©2022 Sound United. All Rights Reserved.