

marantz®

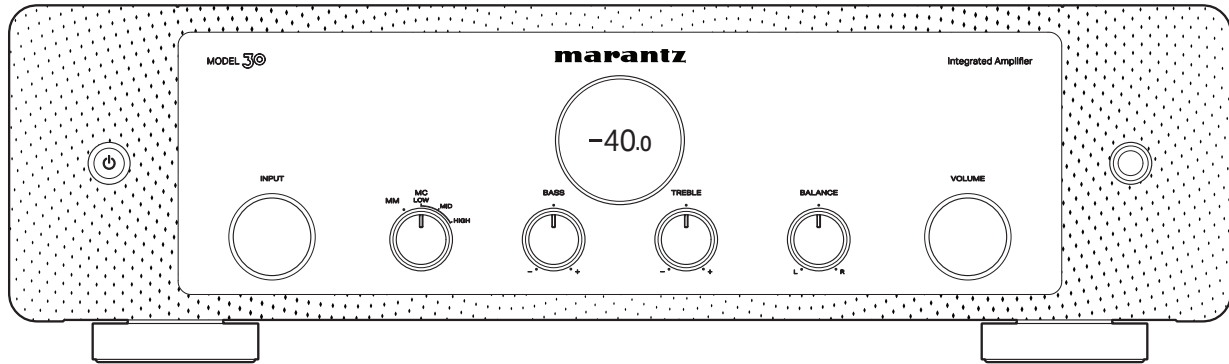

MODEL 30 | Integrated Amplifier

快速入门指南

欢迎

感谢您选购Marantz放大器。
本指南为您设置放大器提供逐步说明。

开始之前

包装盒中物品清单

快速入门指南

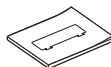

放大器



安全说明



电源线



保修卡



遥控器
(RC002PMND)

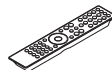

R03/AAA 电池



基本连接所需物品

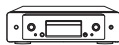

CD播放机



扬声器



扬声器电缆



请注意，本手册中的插图为示意图，可能与实物有差异。

设置步骤

设置过程包括五个步骤。

- 1 正在遥控器单元中安装电池
- 2 将扬声器连接到MODEL 30
- 3 将CD播放机连接到MODEL 30
- 4 将电源线插入电源插座
- 5 开始播放CD

1 正在遥控器单元中安装电池

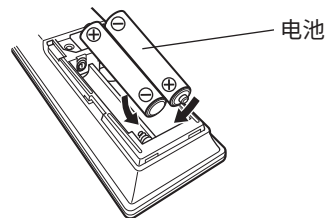
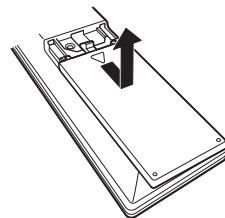

2 将扬声器连接到MODEL 30

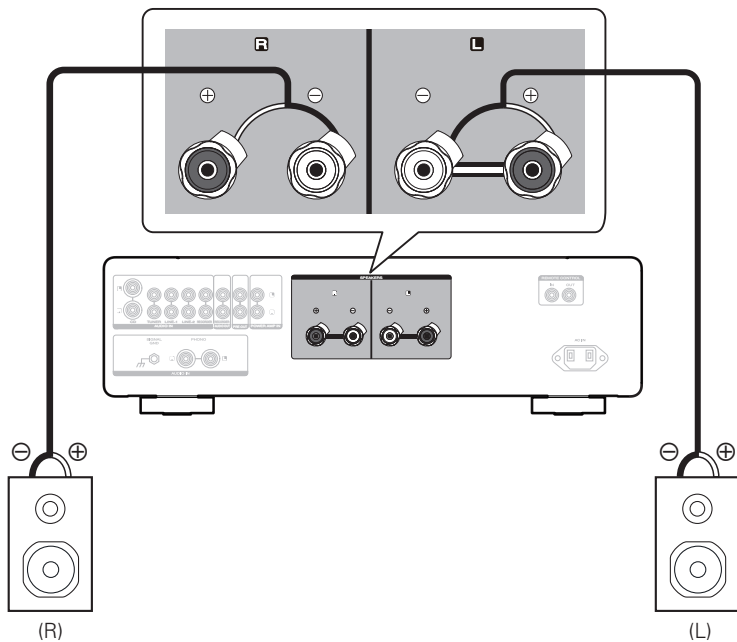

连接扬声器电缆

- ① 从扬声器电缆一端剥去约10毫米的铠装，然后搓捻或端接芯线。
- ② 逆时针转动扬声器端子进行松动。
- ③ 将扬声器电缆芯线完全插入扬声器端子。
- ④ 顺时针转动扬声器端子进行紧固。

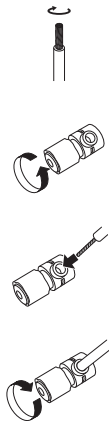

3 将CD播放机连接到MODEL 30

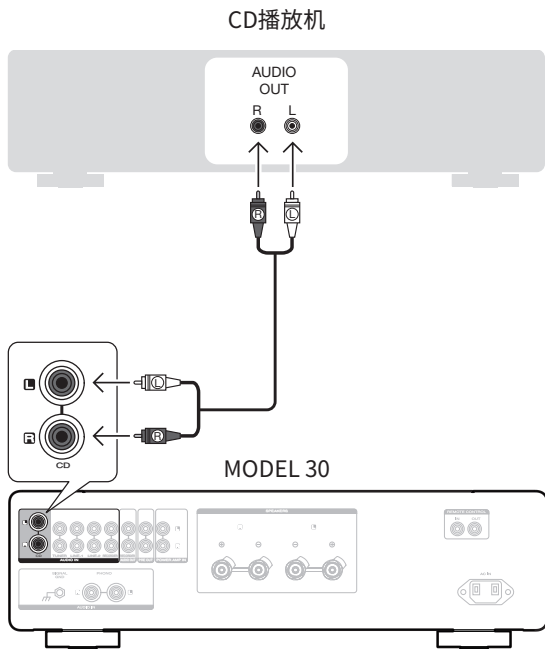

4 将电源线插入电源插座

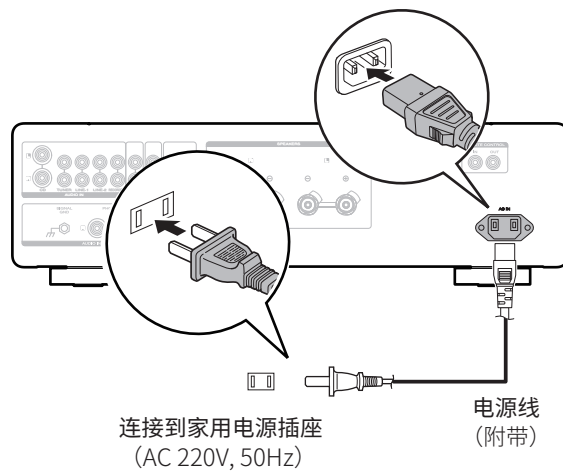

操作说明书

- 有关其他功能信息和操作步骤详情，请参阅在线手册。
manuals.marantz.com/Model30/AP/ZH/

5 开始播放CD

1 按电源操作键。



2 设置输入源为“CD”。



3 播放CD播放机。

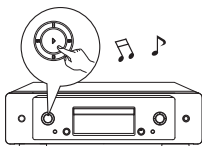

4 调节音量。



在线手册

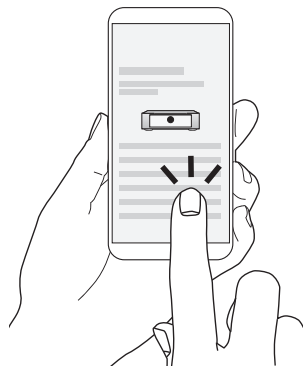

- 有关更多信息，请访问 www.marantz.com.cn



www.marantz.com.cn

您能在我们的网站上找到离您最近的授权分销商或经销商。

marantz[®] 是注册商标

D&M Holdings Inc.

日本天龙马兰士集团有限公司

Printed in Japan 5411 11845 10AM
© 2020 Sound United. All Rights Reserved.