

# marantz®

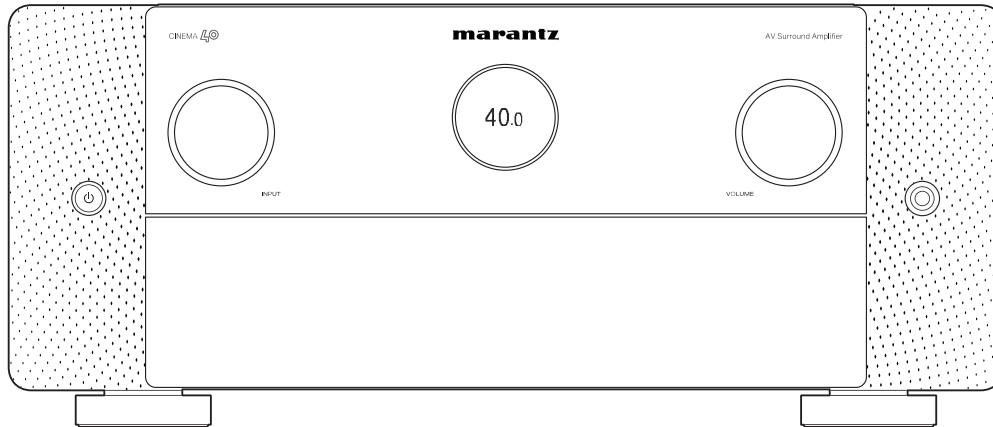

CINEMA 40 | AV Surround Amplifier

QUICK START GUIDE

# Welcome

Thank you for choosing a Marantz AVR.

Use the Setup Assistant function to help configure the settings for this unit when you first set it up.

Follow the guidance displayed on the TV screen connected to this unit to configure the settings.

This manual describes the procedure up until starting the Setup Assistant.

**Please do not return this unit to the store – call for assistance.**

**If you need help... :**

If you need additional help in solving problems, contact Marantz customer service in your area.

**[www.marantz.com](http://www.marantz.com)**

# Before you begin

## Required for setup

TV



HDMI® cable



Speakers

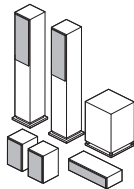

Speaker cables



Subwoofer cable



## Optional

LAN cable



or

Wi-Fi® router



- When connecting this unit to a device that is compatible with the Deep Color, 4K, ARC and eARC functions, use a "High Speed HDMI cable with Ethernet" that displays the HDMI logo.
- When connecting this unit to a device that is compatible with 8K and 4K 120Hz video, use a certified "Ultra High Speed HDMI cable". If you use a different HDMI cable, the video may not display or other problems may occur.

## What's in the box

Quick start guide

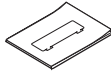

Cable labels



Sound calibration microphone stand

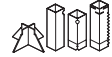

Safety instructions



AVR

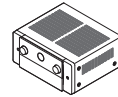

Remote control (RC048SR)

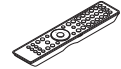

Cautions on using batteries

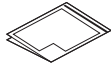

Power cord



2× R03/AAA batteries



Notes on radio

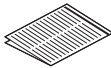

Sound calibration microphone



External antennas for Bluetooth®/wireless connectivity



- The included sound calibration microphone stand is convenient for performing speaker calibration. Using your own tripod or the supplied sound calibration microphone stand enables settings to be automatically configured to the optimum listening environment, providing exceptionally high performance.

## Attach the included cable labels

The supplied cable labels include labels for the speaker and HDMI cables.

Attach a cable label to each cable that matches the speakers and HDMI devices being connected, as shown below.

This makes it easy to identify and properly connect the cables between your components.

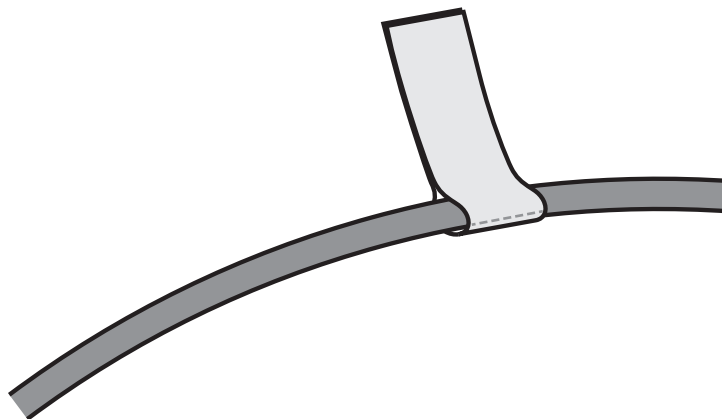

# Setup

## 1 Connect the antennas

- 1) Place the antenna evenly over the antenna terminal located at the upper left or right corner of the rear panel.
- 2) Turn the antenna clockwise until it is fully connected. Do not over tighten.
- 3) Rotate the antenna upwards for the best possible reception.

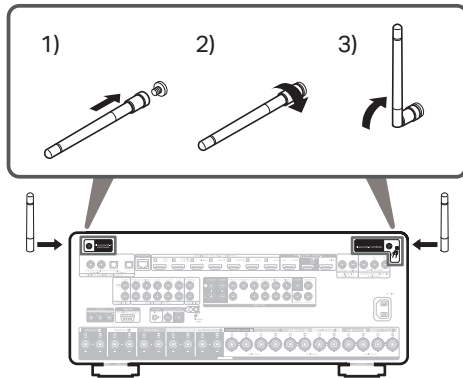

- The antennas are required for both Bluetooth and Wi-Fi functions.

## Optional

If you are connecting the AVR to a wired network, connect an Ethernet cable (not included) between the AVR and your router. Do not connect the Ethernet cable if you are connecting the AVR to a wireless network.

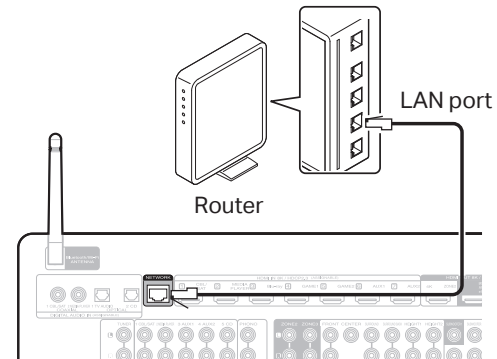

## 2 Connect the power cord

Place the AVR near your TV and connect the power cord.

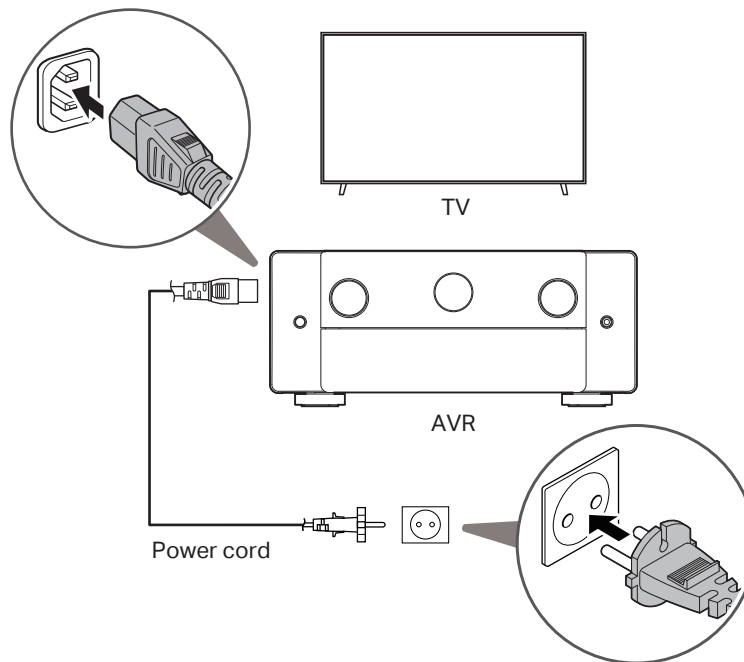

### 3 Connect the AVR to your TV

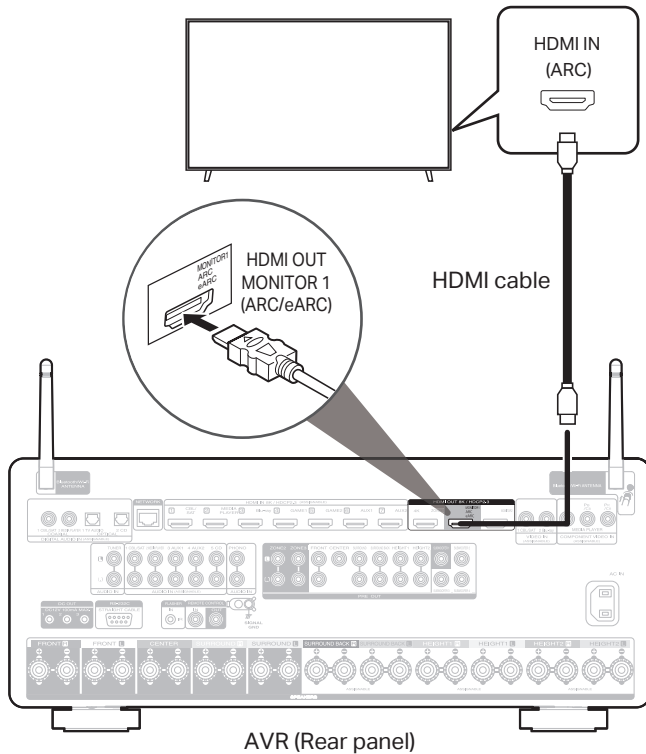

Using a high quality HDMI cable\*, connect one end to the HDMI port labeled "eARC" or "ARC" on your TV. Connect the other end to the HDMI OUT MONITOR 1 port on your AVR.

#### What is ARC and eARC?

Audio Return Channel or "ARC" sends audio back to the AVR using the same HDMI cable that sends video from your AVR to your TV. This allows your AVR to process the sound from your TV's built-in tuner and apps. TVs with an Enhanced Audio Return Channel or "eARC" port provide additional support for high bitrate multichannel audio (Dolby Atmos, Dolby TrueHD, DTS-HD and DTS:X). Please refer to your TV owner's manual for details about eARC support for your particular model.

\* For 4K TVs, we recommend using an HDMI cable labeled "High Speed" and "with Ethernet".

\* For 8K TVs, we recommend using an HDMI cable labeled "Ultra High Speed".



## 4 Turn on the TV

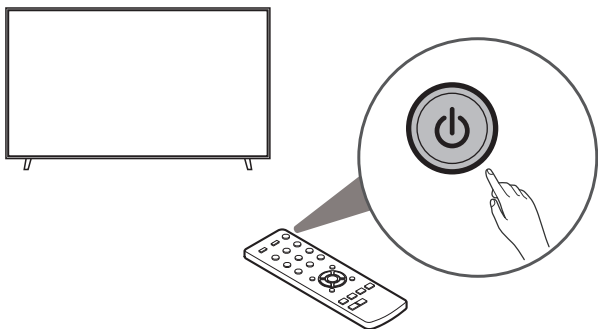

TV remote control

## 5 Select the appropriate HDMI input on your TV

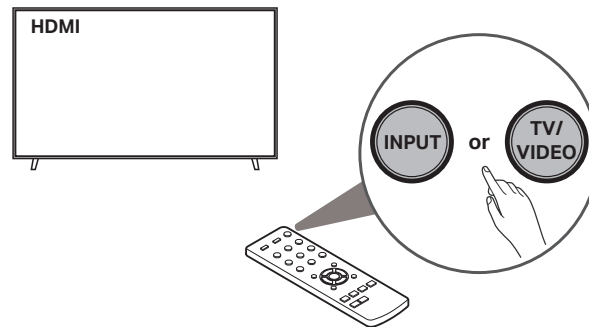

TV remote control

## 6 Install batteries in the AVR remote control

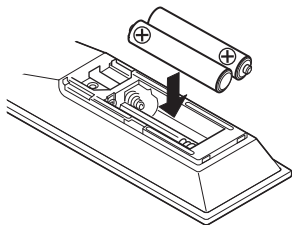
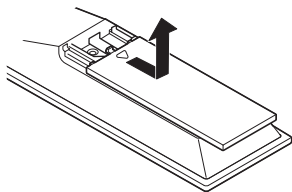

- Batteries can be taken out in reversed order.

## 7 Turn on the AVR

- Press  on the remote control.

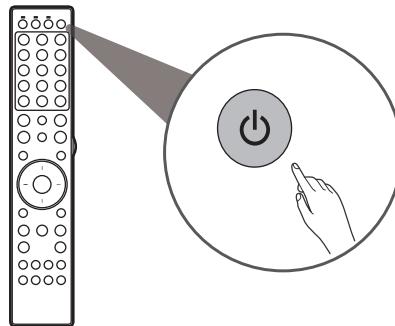
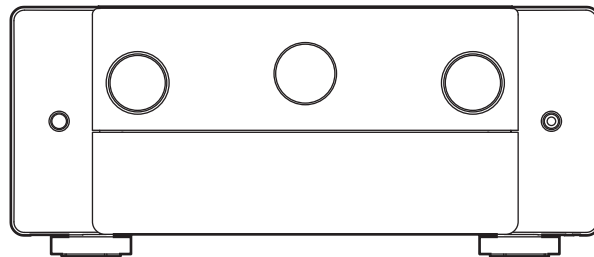

## 8 Verify the connection

- Verify that you can see this screen on your TV.

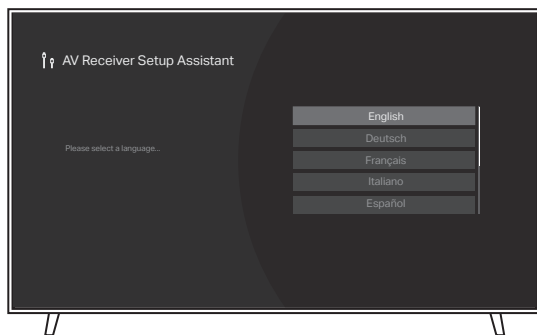

If this screen is not displayed, please go back and retry the steps again in the recommended sequence.



- In case the unit was already setup back in time the Setup Assistant won't start automatically and you only see the Marantz logo on screen. In such case you can access the Setup Assistant by pressing SETUP on the remote control and selecting Setup Assistant from the menu.

## 9 Follow the on-screen Setup Assistant

The TV is now connected to the AVR.

The Setup Assistant will walk you through connecting and configuring your speakers and components to your Marantz AVR. Use the remote control and follow the instructions on the TV screen to complete the AVR settings using the Setup Assistant.

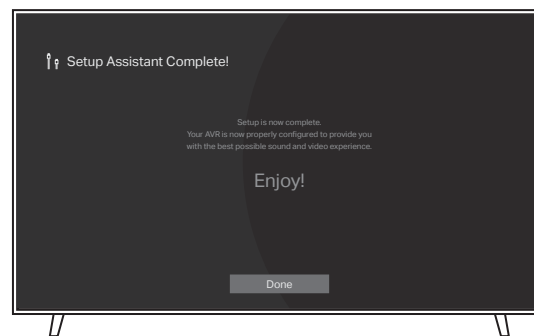

# Firmware update

If you see this screen after completing Setup Assistant, select Update Now to make sure your new AVR is up to date with the latest firmware and features.

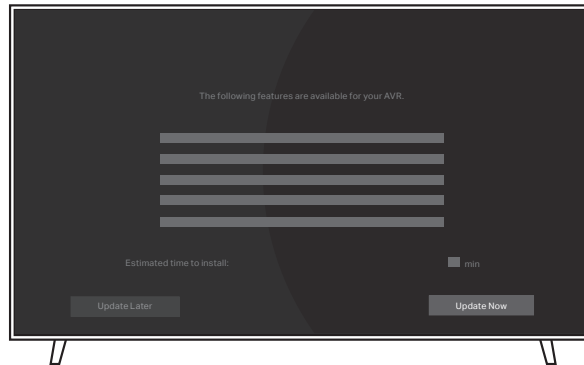

# Download the mobile apps

Download both the “HEOS” app and the “Marantz AVR Remote” app for the full home entertainment experience. The HEOS app is required to access online music through your AVR.



## HEOS app

The HEOS app allows you to explore, browse, and play music from many online streaming services or from your own music library.



## Marantz AVR Remote

Control your new AVR with the latest Marantz AVR Remote app.



# Owner's manual

Refer to the online manual for other functions, information, and operation procedure details.

**[manuals.marantz.com/CINEMA40/EU/EN/](http://manuals.marantz.com/CINEMA40/EU/EN/)**



Online manual

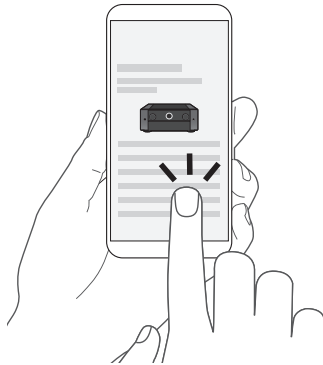

For more information, visit **[www.marantz.com](http://www.marantz.com)**



# Trademark information



The Bluetooth® word mark and logos are registered trademarks owned by the Bluetooth SIG, Inc. and any use of such marks by D&M Holdings Inc. is under license. Other trademarks and trade names are those of their respective owners.



The terms HDMI and HDMI High-Definition Multimedia Interface, and the HDMI Logo are trademarks or registered trademarks of HDMI Licensing, LLC in the United States and other countries.



Manufactured under license from Dolby Laboratories. Dolby, Dolby Atmos, Dolby Audio, Dolby Vision, and the double-D symbol are trademarks of Dolby Laboratories Licensing Corporation. Confidential unpublished works. Copyright © 1992-2022 Dolby Laboratories. All rights reserved.



App Store® is registered in the U.S. and other countries.



Google Play and the Google Play logo are trademarks of Google LLC.



For DTS patents, see <http://patents.dts.com>. Manufactured under license from DTS, Inc. DTS, DTS:X, and the DTS:X logo are registered trademarks or trademarks of DTS, Inc. in the United States and other countries. © 2021 DTS, Inc. ALL RIGHTS RESERVED.



The Wi-Fi CERTIFIED logo is a registered trademark of the Wi-Fi Alliance. Wi-Fi Certification provides assurance that the device has passed the interoperability test conducted by the Wi-Fi Alliance, a group that certifies interoperability among wireless LAN devices.





**marantz®**