



**marantz**

Integrated Amplifier  
**PM6007**

Front panel

Rear panel

Remote control  
unit

Index

Owner's Manual



<b>Accessories</b>	<b>4</b>
Inserting the batteries	5
Operating range of the remote control unit	5
<b>Part names and functions</b>	<b>6</b>
Front panel	6
Rear panel	8
Remote control unit	10

## Connections

<b>Connecting speakers</b>	<b>16</b>
Speaker A/B connection	17
Bi-wiring connection	18
Subwoofer connection	19
<b>Connecting a playback device</b>	<b>20</b>
<b>Connecting a recording device</b>	<b>21</b>
<b>Connecting to a device with digital audio output connectors</b>	<b>22</b>
<b>Connecting devices with remote control connectors</b>	<b>23</b>
Performing operations by RC on this unit without visual contact	23
Remotely connecting Marantz audio devices	23
<b>Connecting the power cord</b>	<b>24</b>

## Playback

Turning the power on	26
Switching the power to standby	26
Selecting the speakers for audio output	27
Selecting the input source	27
Adjusting the volume	27
Turning off the sound temporarily (Muting)	27
Adjusting the tone and balance	28
Playing CDs	28
Connecting and playing back from a digital device (Coaxial/ Optical)	29
Recording	30



## Settings

<b>Setting the Auto Standby mode</b>	<b>32</b>
<b>Setting the remote signal receiving function</b>	<b>33</b>
Disabling the remote signal receiving function of the remote control unit	33
Enabling the remote signal receiving function of the remote control unit	33
<b>Setting remote control codes</b>	<b>34</b>
Setting remote control codes for the remote control	35
Setting remote control codes for the main unit	35

## Tips

<b>Tips</b>	<b>37</b>
<b>Troubleshooting</b>	<b>38</b>
Power does not turn on / Power is turned off	39
Operations cannot be performed through the remote control unit	40
No sound comes out	41
Desired sound does not come out	41
Sound is interrupted or noise occurs	42
FILTER 1·2 indicator does not light	42

## Appendix

<b>D/A converter</b>	<b>43</b>
<b>Explanation of terms</b>	<b>43</b>
<b>Trademark information</b>	<b>44</b>
<b>Specifications</b>	<b>45</b>
<b>Index</b>	<b>48</b>







Thank you for purchasing this Marantz product.

To ensure proper operation, please read this owner's manual carefully before using the product.

After reading this manual, be sure to keep it for future reference.

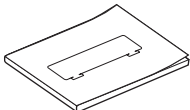
## Accessories

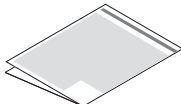
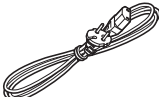
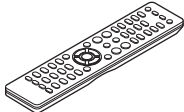
Check that the following parts are supplied with the product.

 Quick Start Guide	 CD-ROM (Owner's Manual)	 Safety Instructions	 Cautions on Using Batteries
 Power cord	 Remote control unit (RC004PMCD)	 R03/AAA batteries	



## Inserting the batteries

- 1 Remove the rear lid in the direction of the arrow and remove it.

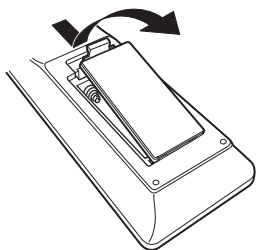

- 2 Insert two batteries correctly into the battery compartment as indicated.

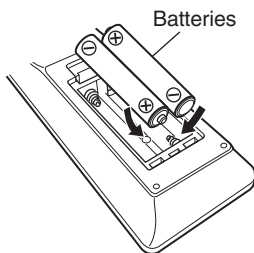

- 3 Put the rear lid back on.

### NOTE

- To prevent damage or leakage of battery fluid:
  - Do not use a new battery together with an old one.
  - Do not use two different types of batteries.
- Remove the batteries from the remote control unit if it will not be in use for long periods.
- If the battery fluid should leak, carefully wipe the fluid off the inside of the battery compartment and insert new batteries.

## Operating range of the remote control unit

Point the remote control unit at the remote sensor when operating it.

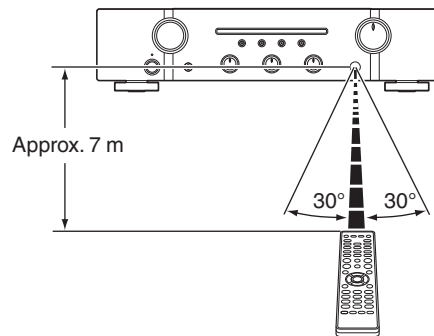

# Part names and functions

## Front panel

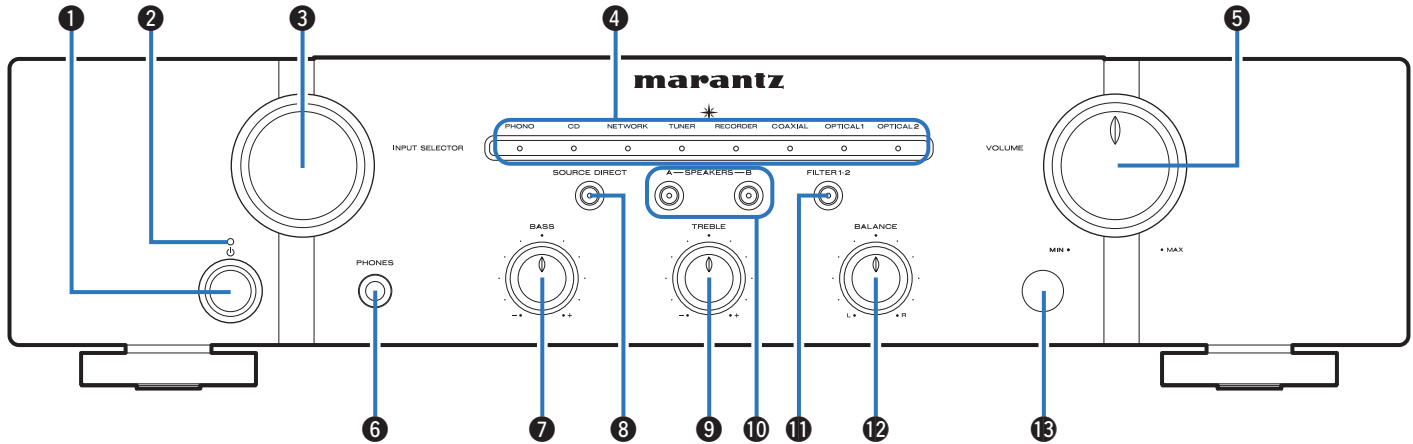

For details, see the next page.



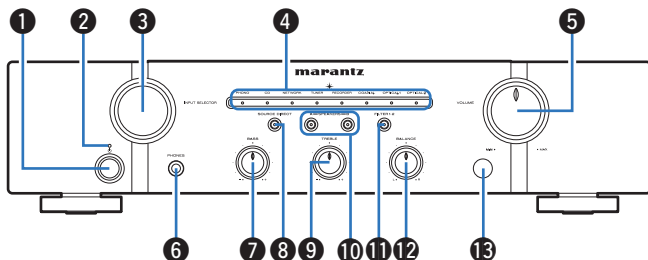

### ❶ Power operation button (⏻)

This turns the power on/off. (👉 p. 26)

### ❷ Power indicator

This is lit as follows according to the power status:

- Power on : Off
- Standby : Red
- Power off : Off

### ❸ INPUT SELECTOR knob

This selects the input source. (👉 p. 27)

### ❹ Input indicators (👉 p. 27)

### ❺ VOLUME knob

These adjust the volume level. (👉 p. 27)

### ❻ Headphones jack (PHONES)

Used to connect headphones.

Turn off speaker output when using headphones. (👉 p. 27)

#### NOTE

- To prevent hearing loss, do not raise the volume level excessively when using headphones.

### ❼ BASS control knob

This setting adjusts the volume level for the bass. (👉 p. 28)

### ❽ SOURCE DIRECT button/indicator

This turns source direct mode on/off. (👉 p. 28)

### ❾ TREBLE control knob

This setting adjusts the volume level for the treble. (👉 p. 28)

### ❿ Speaker switching buttons/indicators (SPEAKERS A/B)

These select the speaker for audio output. (👉 p. 27)

### ⓫ FILTER 1·2 button/indicator

Switches the filter characteristics when digital audio is input. (👉 p. 29)

### ⓬ BALANCE control knob

This adjusts the balance of the volume output from the left and right speakers. (👉 p. 28)

### ⓭ Remote control sensor

This receives signals from the remote control unit. (👉 p. 5)



- ❷, ❹ and ❿ can be adjusted when ❽ is off (Source direct mode is off).



## Rear panel

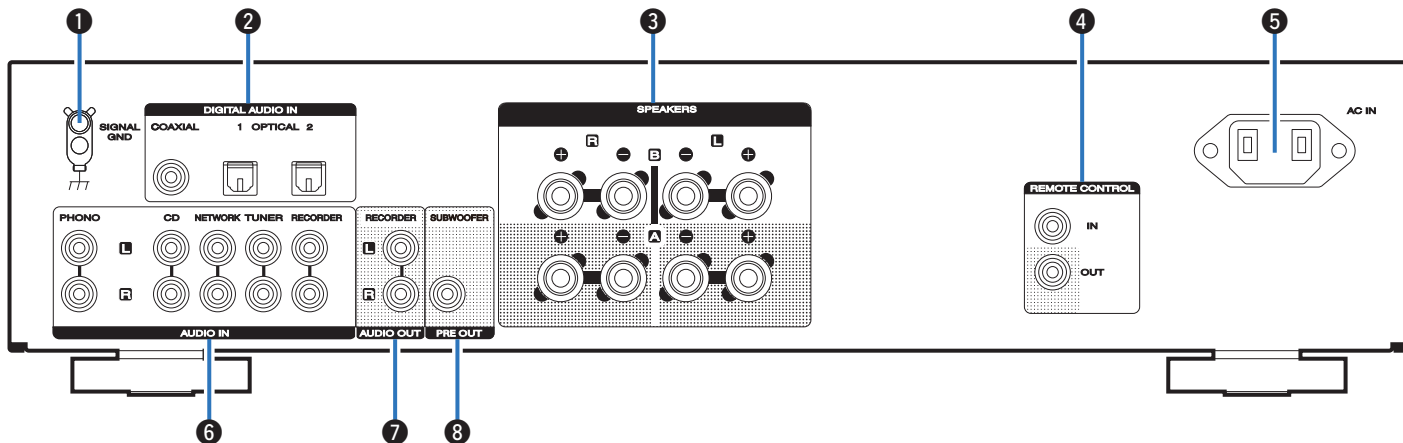

For details, see the next page.





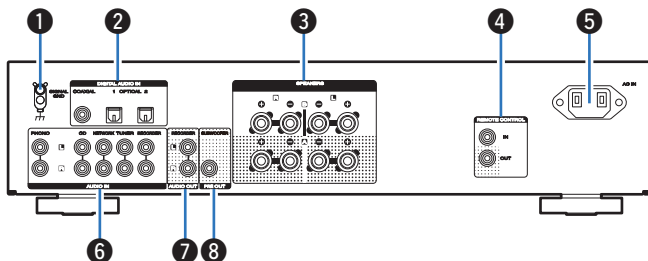

**1 SIGNAL GND terminal**

Used to connect a turntable. (☞ p. 20)

**2 Digital audio input connectors (DIGITAL AUDIO IN)**

Used to connect devices equipped with digital audio output connectors. (☞ p. 22)

**3 Speaker terminals (SPEAKERS)**

Used to connect speakers. (☞ p. 16)

**4 Remote control input/output connectors (REMOTE CONTROL)**

Used to connect to a Marantz audio device that is compatible with the remote control function. (☞ p. 23)

**5 AC inlet (AC IN)**

Used to connect the power cord. (☞ p. 24)

**6 Analog audio input connectors (AUDIO IN)**

Used to connect devices equipped with analog audio output connectors.

- “Connecting a playback device” (☞ p. 20)
- “Connecting a recording device” (☞ p. 21)

**7 AUDIO OUT connectors (RECORDER)**

Used to connect the input connector of a recorder. (☞ p. 21)

**8 PRE OUT connector (SUBWOOFER)**

Used to connect a subwoofer with a built-in amplifier. (☞ p. 19)



## Remote control unit

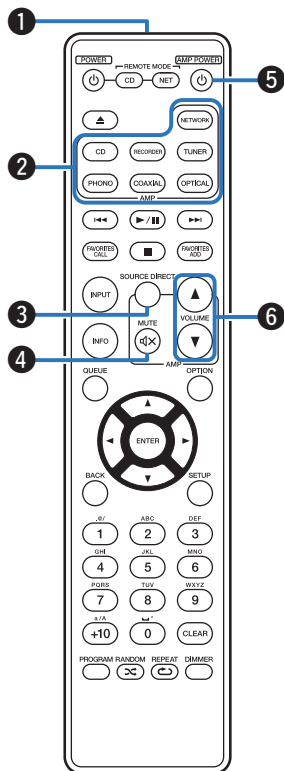

The remote control provided with this unit can control a network audio player in addition to a Marantz CD player.

- “CD player operations” (☞ p. 11)
- “Network audio player operations” (☞ p. 13)

### ■ Operating this unit

#### 1 Remote control signal transmitter

This transmits signals from the remote control unit. (☞ p. 5)

#### 2 Input source select buttons

This selects the input source. (☞ p. 27)

#### 3 SOURCE DIRECT button

This turns source direct mode on/off. (☞ p. 28)

#### 4 MUTE button (⏏)

This mutes the output audio. (☞ p. 27)

#### 5 Power operation button (AMP POWER ⏻)

This turns the power on/off (standby). (☞ p. 26)

#### 6 VOLUME buttons (▲▼)

These adjust the volume level. (☞ p. 27)



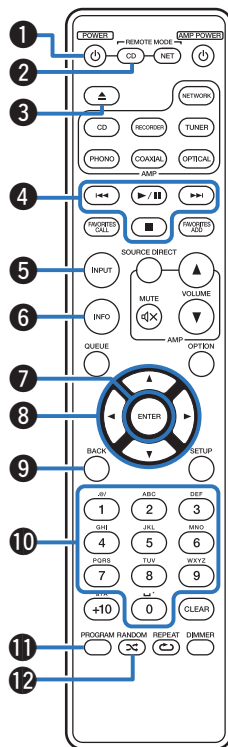

## CD player operations

You can operate a Marantz CD player. To operate a Marantz CD player, press the REMOTE MODE CD button to switch the remote control to the CD player operation mode.

- REMOTE MODE CD button lights for approximately two seconds.

- 1 Power operation button (POWER  $\phi$ )
- 2 Remote mode select button (REMOTE MODE CD)
- 3 Disc tray open/close button (▲)
- 4 System buttons
- 5 Media mode select button (INPUT)
- 6 Information button (INFO)
- 7 ENTER button
- 8 Cursor buttons (▲▼◀▶)
- 9 BACK button
- 10 Number buttons (0 – 9)
- 11 PROGRAM button
- 12 RANDOM button (∞)



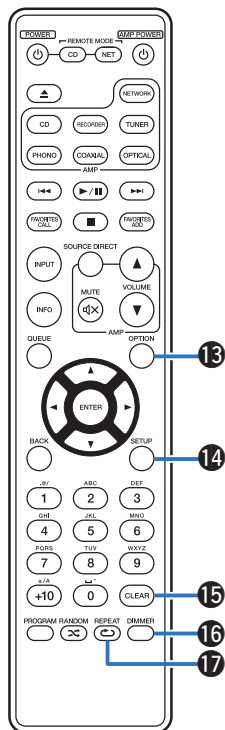

- 13 **OPTION** button
- 14 **SETUP** button
- 15 **CLEAR** button
- 16 **DIMMER** button
- 17 **REPEAT** button (↺)



- The remote control may not operate some products.
- The amp can be operated with the amp operation buttons even when the remote control operation mode is set to CD.



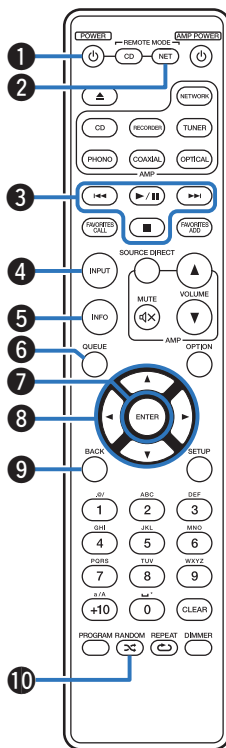

## Network audio player operations

You can operate a Marantz network audio player. To operate a Marantz network audio player, press the REMOTE MODE NET button to switch the remote control to the network audio player operation mode.

- REMOTE MODE NET button lights for approximately two seconds.

- 1 Power operation button (POWER  $\text{\textcircled{P}}$ )
- 2 Remote mode select button (REMOTE MODE NET)
- 3 System buttons
- 4 Input source select button (INPUT)
- 5 Information button (INFO)
- 6 QUEUE button
- 7 ENTER button
- 8 Cursor buttons ( $\Delta \nabla \triangleleft \triangleright$ )
- 9 BACK button
- 10 RANDOM button ( $\text{\textcircled{R}}$ )



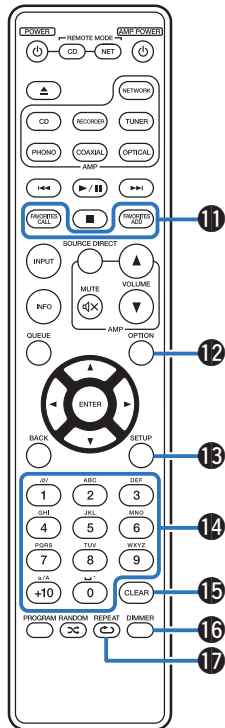

- 11 FAVORITES ADD / CALL buttons
- 12 OPTION button
- 13 SETUP button
- 14 Number/letter buttons (0 – 9, +10)
- 15 CLEAR button
- 16 DIMMER button
- 17 REPEAT button (↺)



- The remote control may not operate some products.
- The amp can be operated with the amp operation buttons even when the remote control mode is NET.



## ■ Contents

Connecting speakers	16
Connecting a playback device	20
Connecting a recording device	21
Connecting to a device with digital audio output connectors	22
Connecting devices with remote control connectors	23
Connecting the power cord	24

### NOTE

- Do not plug in the power cord until all connections have been completed.
- Do not bundle power cords together with connection cables. Doing so can result in humming or noise.

## ■ Cables used for connections

Provide necessary cables according to the devices you want to connect.

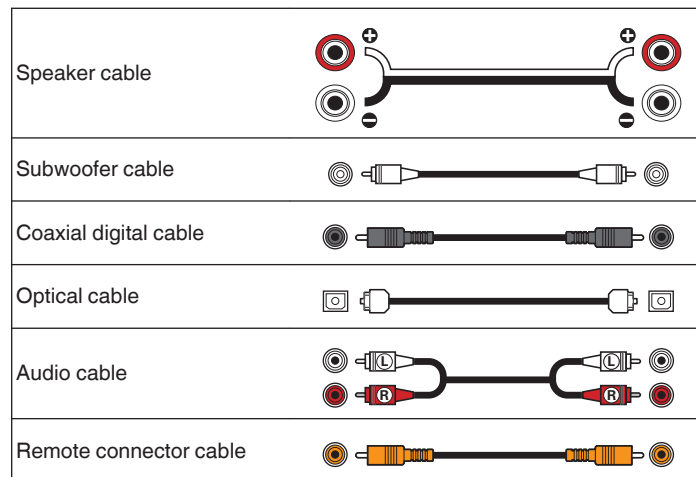

# Connecting speakers

## NOTE

- Disconnect this unit's power plug from the power outlet before connecting the speakers.
- Connect so that the speaker cable core wires do not protrude from the speaker terminal. The protection circuit may be activated if the core wires touch the rear panel or if the + and - sides touch each other. ("Protection circuit" (👉 p. 43))
- Never touch the speaker terminals while the power cord is connected. Doing so could result in electric shock.
- Use speakers with impedances within the ranges shown below to suit how they are used.

Speaker terminals used on this unit	No. of connected speakers	Speaker Impedance
<b>SPEAKERS A (Standard connection)</b>	2 (one set)	4 – 16 Ω/ohms
<b>SPEAKERS B</b>	2 (one set)	4 – 16 Ω/ohms
<b>SPEAKERS A and SPEAKERS B</b>	4 (two sets)	8 – 16 Ω/ohms
<b>SPEAKERS A and SPEAKERS B (Bi-wiring connection)</b>	2 (one set)	4 – 16 Ω/ohms

## ■ Connecting the speaker cables

Carefully check the left (L) and right (R) channels and + (red) and – (black) polarities on the speakers being connected to this unit, and be sure to connect the channels and polarities correctly.

- 1 Peel off about 10 mm of sheathing from the tip of the speaker cable, then either twist the core wire tightly or terminate it.**



- 2 Turn the speaker terminal counterclockwise to loosen it.**



- 3 Insert the speaker cable's core wire to the hilt into the speaker terminal.**



- 4 Turn the speaker terminal clockwise to tighten it.**





## Speaker A/B connection

This unit is equipped with two sets of speaker terminals (SPEAKER A and SPEAKER B). One set of speakers can be connected to each set of terminals, and a total of two sets of speakers can be connected.

The same signal is output from the SPEAKERS A and SPEAKERS B terminals.

When only one set of speakers is to be connected, use either the SPEAKERS A or SPEAKERS B terminals.

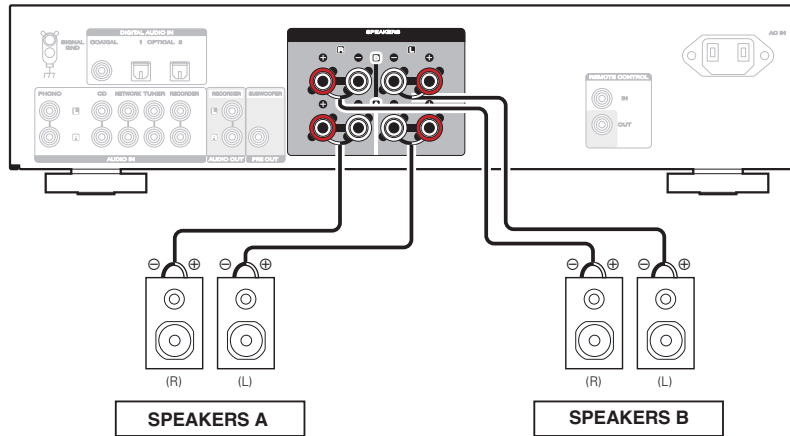

## Bi-wiring connection

This connection limits the effects of signal interference between the high range speakers (tweeters) and low range speakers (woofers), allowing you to enjoy high quality playback.

When bi-wiring with bi-wireable speakers, connect the mid and high range terminals to SPEAKERS B (or SPEAKERS A), the low range terminals to SPEAKERS A (or SPEAKERS B).

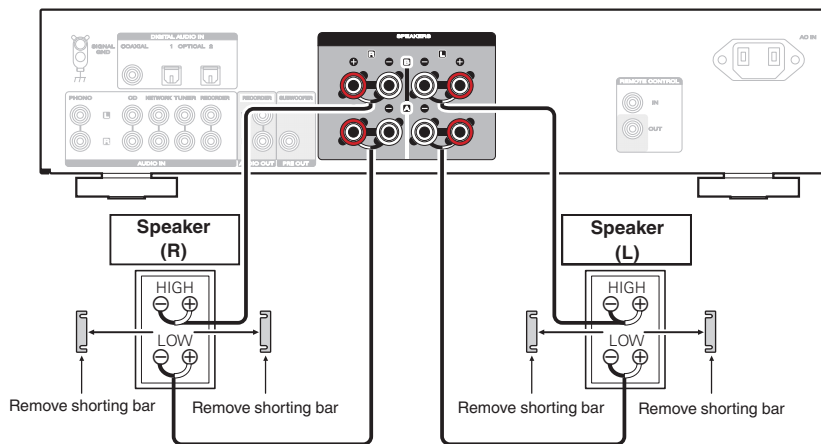

## Subwoofer connection

Use a subwoofer cable to connect the subwoofer.

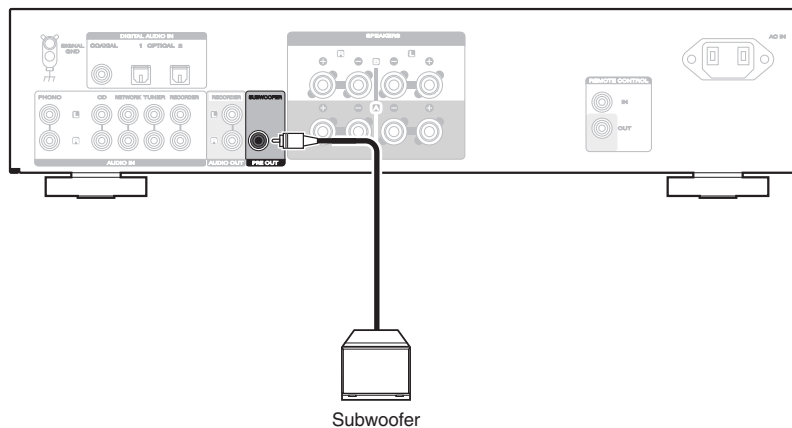

- The subwoofer volume is linked to the Speaker A volume.
- This unit does not output to the subwoofer when not set to output audio from the SPEAKERS A terminal. (p. 27)



## Connecting a playback device

You can connect turntables, CD players, network audio players and tuners to this unit.

This unit is compatible with turntables equipped with a moving magnet (MM) phono cartridge. When you connect to a turntable with a low output moving coil (MC) cartridge, use a commercially available MC head amp or a step-up transformer.

If you set this unit's input source to "PHONO" and you accidentally increase the volume without having a turntable connected, you may hear a hum noise from the speakers.

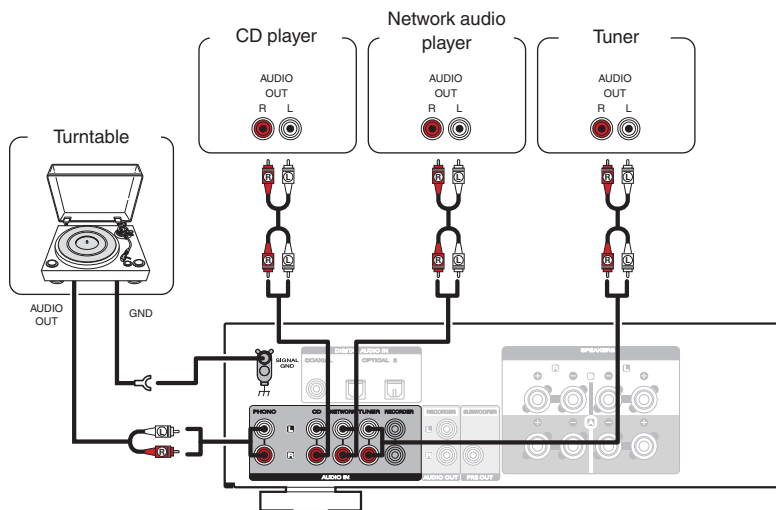

### NOTE

- The earth terminal (SIGNAL GND) of this unit is not for safety grounding purposes. If this terminal is connected when there is a lot of noise, the noise can be reduced. Note that depending on the turntable, connecting the ground line may have the reverse effect of increasing noise. In this case, it is not necessary to connect the ground line.



## Connecting a recording device

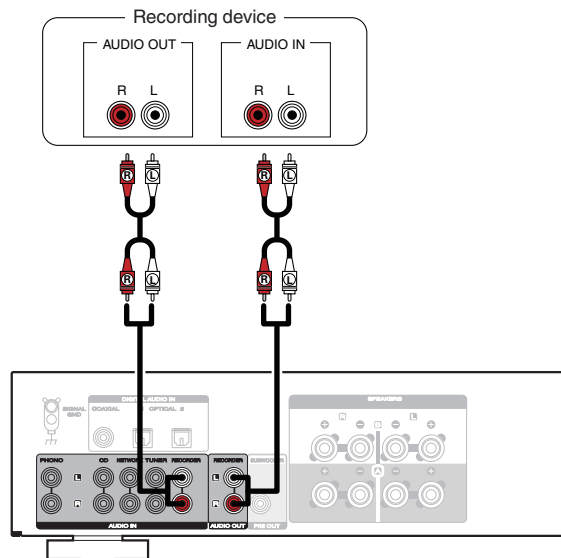

### NOTE

- Never insert the short-circuiting pin plug into the recording output connectors (AUDIO OUT RECORDER). Doing so could result in damage.



## Connecting to a device with digital audio output connectors

Use this connection to input digital audio signals to this unit, and convert the signals for playback using the D/A converter of this unit. (🔍 p. 29)

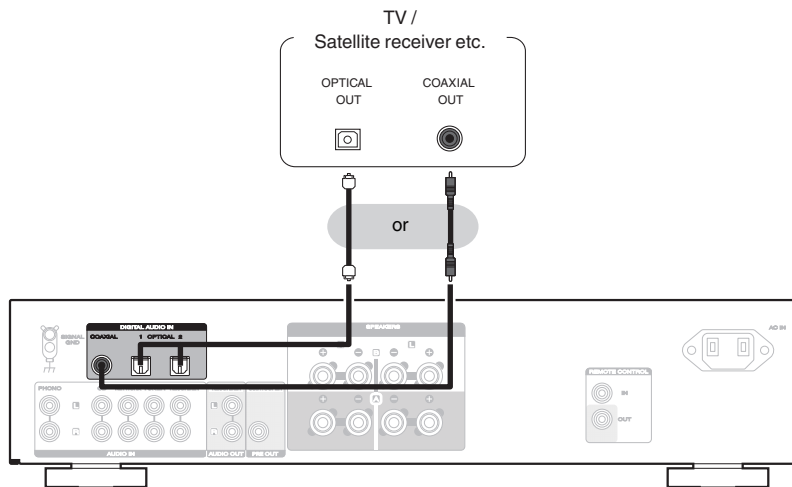

### NOTE

- Linear PCM signals with a sampling frequency of 32 kHz, 44.1 kHz, 48 kHz, 88.2 kHz, 96 kHz, 176.4 kHz, or 192 kHz can be input into this unit.
- Do not input non-PCM signals, such as Dolby Digital, DTS and AAC. This causes noise and could damage the speakers.



## Connecting devices with remote control connectors

### Performing operations by RC on this unit without visual contact

You can connect an external IR receiver to the REMOTE CONTROL connectors to perform operations on this unit with the supplied remote control unit without visual contact. This might be necessary if the unit is hidden in a cupboard or corner, so you can't directly point with the remote control unit to the device.

To do this, disable the remote control signal receiving function "Setting the remote signal receiving function" (☞ p. 33).

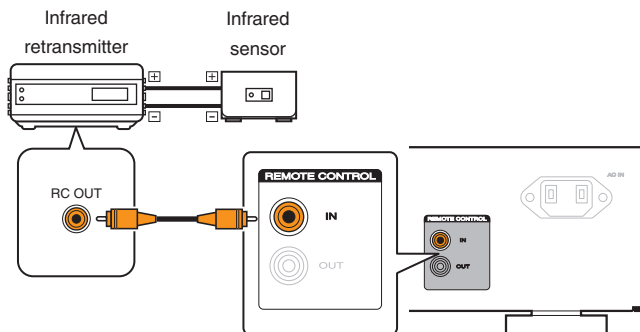

#### NOTE

- When a remote control receiver unit is not connected, be sure to enable the remote control signal receiving function. Operations cannot be performed with the remote control if this function is disabled.

### Remotely connecting Marantz audio devices

You can transmit remote control signals simply by connecting a Marantz audio device to the REMOTE CONTROL IN/OUT connectors using the remote connection cable provided with the device.

Set the remote control switch located on the rear panel of the connected audio component to "EXTERNAL" to use this feature.

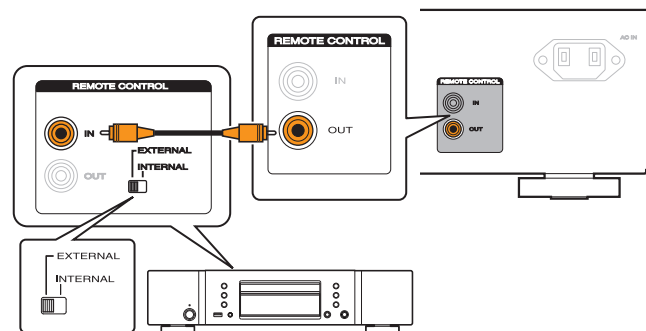

## Connecting the power cord

After completing all the connections, insert the power plug into the power outlet.

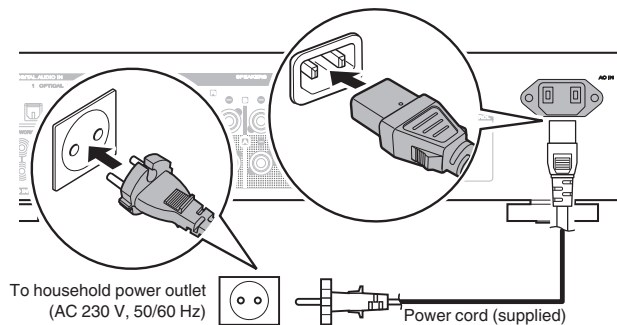



## ■ Contents

Turning the power on	26
Switching the power to standby	26
Selecting the speakers for audio output	27
Selecting the input source	27
Adjusting the volume	27
Turning off the sound temporarily (Muting)	27
Adjusting the tone and balance	28
Playing CDs	28
Connect and playback from a digital device (Coaxial/Optical)	29
Recording	30



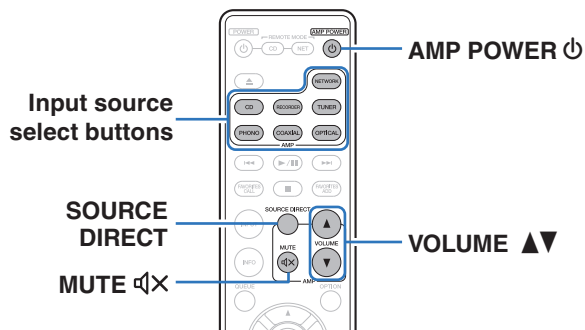

## Turning the power on

### 1 Press ⏻ on the main unit to turn the power on.

Input indicator for the selected source lights in blue.



- Press AMP POWER ⏻ on the remote control unit to turn on power from standby mode.
- You can also turn the INPUT SELECTOR on the main unit when the unit is in standby mode to turn on the power.

#### NOTE

- Turn VOLUME on the main unit to adjust the volume to the lowest level before turning on the power.

## Switching the power to standby

### 1 Press AMP POWER ⏻ on the remote control.

The power indicator lights in red.

#### NOTE

- Power continues to be supplied to some of the circuitry even when the power is in the standby mode. When leaving home for long periods of time or when going on vacation, either press ⏻ on the main unit to turn off the power, or unplug the power cord from the power outlet.

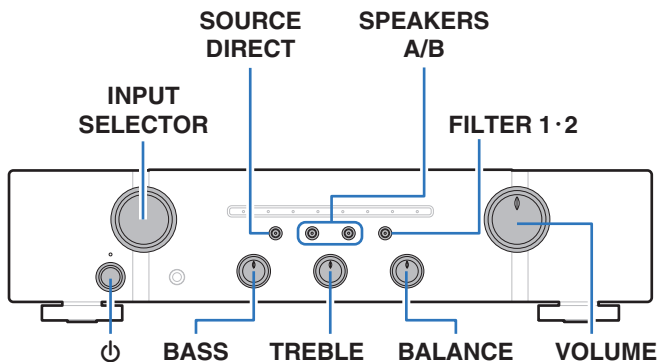

## Selecting the speakers for audio output

- 1 Use **SPEAKERS A/B** on the main unit to select the speaker system to be used for playback.

The indicator of the selected speakers lights.



- When using headphones, press **SPEAKERS A/B** to turn off all of the indicators and turn audio output from the speaker terminals off.

## Selecting the input source

- 1 Press the **input source select button** to be played back.

The indicator of the selected input source lights in blue.



- You can also select the input source by turning **INPUT SELECTOR** on the main unit.

## Adjusting the volume

- 1 Use **VOLUME ▲▼** to adjust the volume.



- You can also adjust the master volume by turning **VOLUME** on the main unit.

## Turning off the sound temporarily (Muting)

- 1 Press **MUTE** .

The indicator of the currently set input source lights in red.



- To cancel mute, press **MUTE**  again.





## Adjusting the tone and balance

- 1 Press SOURCE DIRECT to turn off source direct mode.**  
The SOURCE DIRECT indicator turns off.
- 2 Turn the BASS, TREBLE and BALANCE on the main unit to adjust the tone and balance.**

## Playing CDs

This section uses playback from a CD as an example.

- 1 Press  on the main unit to turn the power on.**
- 2 Press the input source select button (CD) to switch the input source to “CD”.**  
The “CD” input indicator lights in blue.
- 3 Playback the CD.**
- 4 Use VOLUME   to adjust the volume.**

### ■ Playback in source direct mode

The signal does not pass through the tone adjustment circuitry (BASS, TREBLE and BALANCE), resulting in playback of a higher sound quality.

- 1 Press SOURCE DIRECT to turn on source direct mode.**  
The SOURCE DIRECT indicator lights.



## Connecting and playing back from a digital device (Coaxial/Optical)

**1** Connect digital device to this unit. (🔧 p. 22)

**2** Press the input source select button (COAXIAL or OPTICAL) to switch the input source to COAXIAL, OPTICAL 1 or OPTICAL 2.

The indicator of the selected input source lights in blue.



- Pressing OPTICAL changes the input source to “OPTICAL 1” or “OPTICAL 2”.

**3** Start playback of the digital device connected to this unit.



- The “COAXIAL”, “OPTICAL 1” or “OPTICAL 2” input indicator flashes in blue if this unit cannot detect the sampling frequency of the input signal.

**4** Use VOLUME ▲▼ to adjust the volume.

## Switching the filter characteristics

This unit is equipped with a sound quality adjusting function which allows users to enjoy the desired playback sound quality. This function only works when a digital audio signal is input.

**1** Press FILTER 1·2.

This unit switches between Filter 1 and Filter 2 each time the button is pressed.

Filter Type	FILTER 1·2 indicator	Features
Filter 1 (Default)	Lights blue	Offers a short impulse response for both pre-echo and post-echo. Large amount of audio information clearly reproduces deep stereo imaging and the relative position of the sound source.
Filter 2	Lights purple	Both pre-echo and post-echo are slightly longer. The sound characteristics is edge and powerful.



- The FILTER 1·2 indicator lights only when the input source is “COAXIAL”, “OPTICAL 1” or “OPTICAL 2”.



## ■ Specifications of supported audio formats

See “D/A converter” (👉 p. 43).



- If the sampling frequency switches, the sound may be cut for 1–2 seconds.

### NOTE

- Do not input non-PCM signals, such as Dolby Digital, DTS and AAC. This causes noise and could damage the speakers.

## Recording

Audio signals input into this unit can be output to an external recording device. When recording audio from a playback device connected to this unit, audio can be recorded with the playback device still connected to this unit.

- 1 Press  on the main unit to turn the power on.**
- 2 Press the input source select button to switch to the input source from which you want to record.**  
The indicator of the selected input source lights in blue.
- 3 Recording starts.**
  - For information on operations, see the owner’s manual of the recording device.



## ■ Contents

Setting the Auto Standby mode	32
Setting the remote signal receiving function	33
Setting remote control codes	34



## Setting the Auto Standby mode

You can set the unit to automatically switch to standby mode if the unit is not operated for 30 minutes when there is no audio input (Auto Standby mode).

Auto Standby mode is set to on by default.

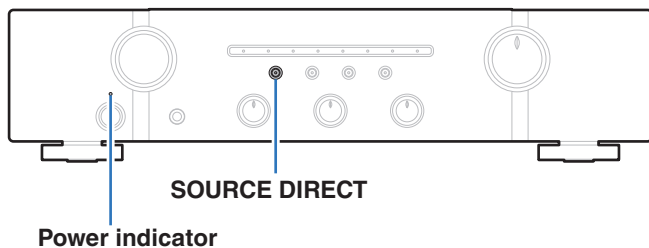

### 1 Press and hold SOURCE DIRECT for 5 seconds or more to switch it on and off.

The power indicator changes as follows each time it is switched on and off.

- When auto standby mode is on: The power indicator blinks in red three times.
- When auto standby mode is off: The power indicator blinks in red once.





## Setting the remote signal receiving function

When you connect a IR receiver (sold separately) to the REMOTE CONTROL IN connector of this unit, use the following procedure to disable the remote signal receiving function of this unit. When the function is enabled, you can not perform operations with the remote control unit.

By default, this function is enabled.

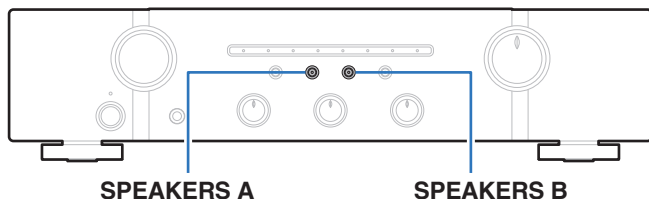

### Disabling the remote signal receiving function of the remote control unit

- 1 **Press SPEAKERS B for approximately 5 seconds to disable the remote control signal receiving function.**  
The indicator of the currently set input source flashes in red three times.

### Enabling the remote signal receiving function of the remote control unit

- 1 **Press SPEAKERS A for approximately 5 seconds to enable the remote control signal receiving function.**  
The indicator of the currently set input source flashes in blue three times.



## Setting remote control codes

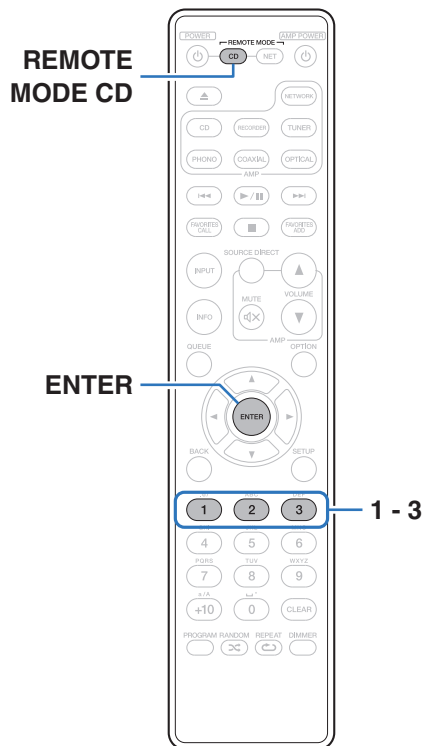

Remote control codes are set between this unit and the supplied remote control. You can select one of the three types of remote control codes, and the remote control can be used to control the unit when the same remote control code is used. If three of these units are used in the same location, all three units can be controlled simultaneously using one remote control in the default settings. By setting individual remote control codes between a unit and the remote control, the remote control can be used to control only the unit that has the same remote control code.

Be sure to check the operation of each unit after setting the remote control codes.

The default setting is “AMP1”.



- Set the remote control cord to “AMP 1” when controlling this unit from a Marantz network audio player or other device connected using a remote connection cable to this unit. (p. 23)



## Setting remote control codes for the remote control

### ■ To set the remote control codes to AMP1, AMP2 or AMP3

- 1 Hold down **REMOTE MODE CD** and one of the number **1, 2 or 3** buttons for more than 5 seconds.
  - Set the remote control code to AMP1, AMP2 or AMP3 according to the selected number button.

#### NOTE

- The remote control codes returns to the default settings when the batteries are removed. Set the remote control codes again after replacing the batteries.

## Setting remote control codes for the main unit

- 1 Point the remote control for which the remote control code was set at the main unit, and press **REMOTE MODE CD** and **ENTER**.

The input indicators on the main unit flash as shown below according to the set remote control code.

Remote control codes	Input indicator
AMP 1	PHONO indicator flashes in red three times
AMP 2	CD indicator flashes in red three times
AMP 3	NETWORK indicator flashes in red three times



## ■ Contents

### Tips

I want to play TV audio at higher quality	37
I want to adjust the tone myself	37
I want sound playback that is faithful to the original sound	37
I want to switch the filter to change the desired sound quality	37
I want to use bi-wiring compatible speakers	37
I want to operate a Marantz CD player or network audio player using the remote control of this unit	37
I want to use more than one unit in one location	37

### Troubleshooting

Power does not turn on / Power is turned off	39
Operations cannot be performed through the remote control unit	40
No sound comes out	41
Desired sound does not come out	41
Sound is interrupted or noise occurs	42
FILTER 1·2 indicator does not light	42



# Tips

---

## I want to play TV audio at higher quality

- Connect the digital audio output connector of the TV to the digital audio input connector (COAXIAL, OPTICAL 1 or OPTICAL 2) of this unit, and switch the input source to the connected (COAXIAL, OPTICAL 1 or OPTICAL 2) connector. (👉 p. 22)
- Only 2-channel linear PCM can be input as the digital audio signal to this unit.

## I want to adjust the tone myself

- Use the BASS, TREBLE and BALANCE knobs to adjust the sound as desired. (👉 p. 28)

## I want sound playback that is faithful to the original sound

- Set the source direct mode on. (👉 p. 28)

## I want to switch the filter to change the desired sound quality

- Switch the filter characteristics. (👉 p. 29)

## I want to use bi-wiring compatible speakers

- This unit is compatible with bi-wiring connections. Enjoy high quality playback by using bi-wiring connections. (👉 p. 18)

## I want to operate a Marantz CD player or network audio player using the remote control of this unit

- Switch the remote control operating mode. (“CD player operations” (👉 p. 11), “Network audio player operations” (👉 p. 13)) Also refer to the CD player or network audio player instruction manuals.

## I want to use more than one unit in one location

- Set individual remote control codes for each combination of devices and remote control. (👉 p. 35)



## Troubleshooting

---

If a problem should arise, first check the following:

1. **Are the connections correct?**
2. **Is the set being operated as described in the owner's manual?**
3. **Are the other devices operating properly?**

If this unit does not operate properly, check the corresponding symptoms in this section.

If the symptoms do not match any of those described here, consult your dealer as it could be due to a fault in this unit. In this case, disconnect the power immediately and contact the store where you purchased this unit.



## Power does not turn on / Power is turned off

### Power is not turned on.

- Check whether the power plug is correctly inserted into the power outlet. (🔍 p. 24)

### Power automatically turns off.

- The Auto Standby mode is on. When approx. 30 minutes pass with no audio input and no operations on the unit, this unit automatically enters the standby mode. To turn off the Auto Standby mode, press the SOURCE DIRECT button for 5 seconds or longer. (🔍 p. 32)

### The power turns off and the power indicator shows one long blink and two short blinks in red.

- This unit's amplifier circuit has failed. Unplug the power cord and contact our customer service center.

### The power turns off and the power indicator shows one long blink and three short blinks in red.

- This unit's power circuit has failed. Unplug the power cord and contact our customer service center.

### The power turns off and the power indicator shows one long blink and four short blinks in red.

- The protection circuit has been activated due to a rise in temperature within this unit. Turn the power off, wait about an hour until this unit cools down sufficiently, and then turn the power on again.
- Please re-install this unit in a place having good ventilation.
- Stop playback on the playback device, and then turn the power off and on again.

### The power turns off and the power indicator shows one long blink and five short blinks in red.

- Check the speaker connections. The protection circuit may have been activated because speaker cable core wires came in contact with each other or a core wire was disconnected from the connector and came in contact with the rear panel of this unit. After unplugging the power cord, take corrective action such as firmly re-twisting the core wire or taking care of the connector, and then reconnect the wire. (🔍 p. 16)
- Turn down the volume and turn on the power again.
- Stop playback on the playback device, and then turn the power off and on again.
- If the problem is not solved by turning the power off and on again, this unit's amplifier circuit or power circuit has failed. Unplug the power cord and contact our customer service center.



## Operations cannot be performed through the remote control unit

### Operations cannot be performed through the remote control unit.

- Batteries are worn out. Replace with new batteries. (👉 p. 5)
- Operate the remote control unit within a distance of about 7 m from this unit and at an angle of within 30°. (👉 p. 5)
- Remove any obstacle between this unit and the remote control unit.
- Insert the batteries in the proper direction, checking the ⊕ and ⊖ marks. (👉 p. 5)
- The set's remote control sensor is exposed to strong light (direct sunlight, inverter type fluorescent bulb light, etc.). Move the set to a place in which the remote control sensor will not be exposed to strong light.
- When using a 3D video device, the remote control unit of this unit may not function due to effects of infrared communications between units (such as TV and glasses for 3D viewing). In this case, adjust the direction of units with the 3D communications function and their distance to ensure they do not affect operations from the remote control unit of this unit.
- Enable the remote signal receiving function. (👉 p. 33)
- The remote control code between this unit and the remote control is different. Set this unit and the remote control to the same remote control code. (👉 p. 34)





## No sound comes out

### No sound comes out of speakers.

- Check the connections for all devices. (👉 p. 15)
- Insert connection cables all the way in.
- Check that input connectors and output connectors are not reversely connected.
- Check cables for damage.
- Check that speaker cables are properly connected. Check that cable core wires come in contact with the metal part on speaker terminals. (👉 p. 16)
- Securely tighten the speaker terminals. Check speaker terminals for looseness. (👉 p. 16)
- Check that the proper input source is selected. (👉 p. 27)
- The volume is set to the minimum level. Adjust the volume to a suitable level. (👉 p. 27)
- Cancel the muting mode. (👉 p. 27)
- Check the settings of the SPEAKERS A/B buttons. (👉 p. 27)

### The COAXIAL, OPTICAL 1 or OPTICAL 2 input indicator is flashing.

- Check the connection of the Coaxial digital cable or Optical cable. (👉 p. 22)
- Set the Digital Audio output signal of the connected device to 2 channel linear PCM. (👉 p. 43)

## Desired sound does not come out

### No sound comes out of a specific speaker.

- Check that speaker cables are properly connected. (👉 p. 16)
- Adjust the BALANCE control knob. (👉 p. 28)

### The left and right of stereo sound is reversed.

- Check whether the left and right speakers are connected to the correct speaker terminals. (👉 p. 17)



## Sound is interrupted or noise occurs

### When playing a record, the sound is distorted.

- Adjust to a proper needle pressure.
- Check the tip of the needle.
- Replace the cartridge.

### When playing a record, a humming noise comes out of the speakers.

- Check that the turntable is connected correctly. (🔗 p. 20)
- If there is a TV or AV device near the turntable, such devices may affect the playback sound. Install the turntable in a location as far away as possible from the TV or other AV devices.

### When playing a record, a humming noise comes out of the speakers when the volume is high. (Howling phenomenon)

- Install the turntable and speakers as far from each other as possible. (🔗 p. 20)
- The vibrations from the speakers are being transmitted to the player through the floor. Use cushions, etc., to absorb the speakers' vibrations.

## FILTER 1·2 indicator does not light

### FILTER 1·2 indicator does not light.

- The FILTER 1·2 indicator lights only when the input source is “COAXIAL”, “OPTICAL 1” or “OPTICAL 2”. Switch the input source to “COAXIAL”, “OPTICAL 1” or “OPTICAL 2”. (🔗 p. 29)



## D/A converter

### ■ Specifications of supported audio formats

#### □ Coaxial/Optical 1/Optical 2

	Sampling frequency	Bit length
Linear PCM (2-channel)	32/44.1/48/88.2/96/ 176.4/192 kHz	16/24 bits



- When a digital sound signal that has a sampling frequency that is not supported by this unit is input, the input indicator (COAXIAL, OPTICAL 1 or OPTICAL 2) flashes.

## Explanation of terms

### Sampling frequency

Sampling involves taking a reading of a sound wave (analog signal) at regular intervals and expressing the height of the wave at each reading in digitized format (producing a digital signal).

The number of readings taken in one second is called the “sampling frequency”. The larger the value, the closer the reproduced sound is to the original.

### Speaker impedance

This is an AC resistance value, indicated in  $\Omega$  (ohms). Greater power can be obtained when this value is smaller.

### Source direct

Playback with higher fidelity to the source becomes possible, as input audio signals are output by bypassing the audio quality-control circuits (BASS/TREBLE/BALANCE).

### Protection circuit

This is a function to prevent damage to devices within the power supply when an abnormality such as an overload, excess voltage occurs or over temperature for any reason.



## Trademark information



Adobe, the Adobe logo and Reader are either registered trademarks or trademarks of Adobe Systems Incorporated in the United States and/or other countries.



# Specifications

- **RMS Power output (20 Hz – 20 kHz simultaneous drive of both channels) :**
  - 45 W x 2 (8  $\Omega$ /ohms load)
  - 60 W x 2 (4  $\Omega$ /ohms load)
- **Total harmonic distortion (20 Hz – 20 kHz simultaneous drive of both channels, 8  $\Omega$ /ohms load) :** 0.08 %
- **Output band width (8  $\Omega$ /ohms load, 0.06 %) :** 10 Hz – 50 kHz
- **Frequency response (CD, 1 W, 8  $\Omega$ /ohms load) :** 10 Hz – 70 kHz +0 dB, –1 dB
- **Damping factor (8  $\Omega$ /ohms load, 40 Hz – 20 kHz) :** 100
- **Input sensitivity/Input impedance**
  - PHONO (MM) :** 2.2 mV/47 k $\Omega$ /kohms
  - CD, TUNER, NETWORK, RECORDER :** 200 mV/20 k $\Omega$ /kohms
- **Output voltage**
  - SUBWOOFER OUT :** 2.8 V (200 mV input, Volume MAX)
- **Maximum allowable PHONO input level (1 kHz) MM :** 100 mV
- **RIAA deviation (20 Hz – 20 kHz) :**  $\pm$ 1.0 dB
- **S/N (IHF-A, 8  $\Omega$ /ohms load)**
  - PHONO (MM) :** 83 dB (5 mV input, 1 W output)
  - CD, TUNER, NETWORK, RECORDER :** 102 dB (2 V input, Rated output)
- **Headphone output:** 50 mW/32  $\Omega$ /ohms



- **Tone Control**
  - BASS (50 Hz) :**  $\pm 10$  dB
  - TREBLE (15 kHz) :**  $\pm 10$  dB
- **Digital input**
  - Coaxial :** 0.5 Vp-p
  - Optical :** -27 dBm or later
- **Operating temperature:** +5 °C - +35 °C
- **Power supply :** AC 230 V, 50/60 Hz
- **Power consumption :** 155 W
- **Power consumption in standby mode :** 0.3 W

For the purpose of improvement, the specifications and design are subject to change without notice.



## ■ Dimensions (Unit : mm)

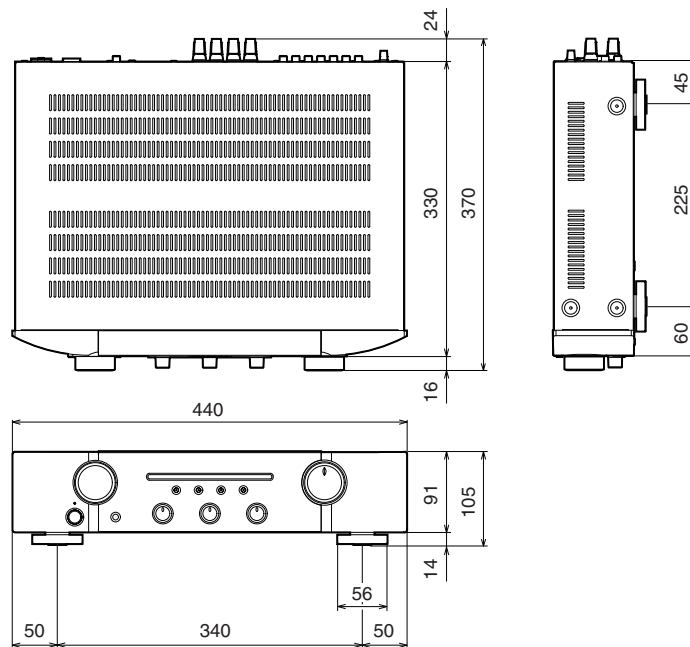

## ■ Weight : 7.8 kg



# Index

<b>A</b>		<b>M</b>		<b>S</b>	
Auto Standby mode .....	32	Muting .....	27	Source direct .....	28, 43
<b>B</b>		<b>N</b>		Speaker impedance .....	43
BALANCE .....	28	Network audio player .....	20	Speakers .....	16
BASS .....	28	<b>P</b>		Speaker (Bi-wiring) connection .....	18
<b>C</b>		Protection circuit .....	43	<b>T</b>	
CD player .....	20, 28	<b>R</b>		Tips .....	37
<b>I</b>		Recording device .....	21	Tone .....	28
Input source .....	27	Remote control .....	23	TREBLE .....	28
		Remote control codes settings .....	35	Troubleshooting .....	38
		Remote control unit .....	10	Tuner .....	20
				Turntable .....	20
				<b>V</b>	
				Volume .....	27





**[www.marantz.com](http://www.marantz.com)**

You can find your nearest authorized distributor or dealer on our website.

**marantz** is a registered trademark.

3520 10762 00AM

© 2020 Sound United. All Rights Reserved.