



marantz®

D/A CONVERTER HD-DAC1

You can print more than one page of a PDF onto a single sheet of paper.

Owner's Manual

[Front panel](#)[Display](#)[Rear panel](#)[Remote](#)[Index](#)

Accessories	4
About the remote control	5
Inserting the batteries	5
Operating range of the remote control unit	5
Main features	6
High quality sound	6
High performance	6
Part names and functions	8
Front panel	8
Display	10
Rear panel	11
Remote control unit	12

Connections

Connecting an amplifier	16
Connecting to a device with digital audio output connectors	17
Connecting a PC or Mac	18
Connecting a smartphone or portable player	19
Connecting an iPod or USB memory device to the USB port	20
REMOTE CONTROL jack	22
Connection	22
Setting	22
Connecting the power cord	23



Playback

Basic operation	25
Turning the power on	25
Selecting the input source	26
Adjusting the volume	26
Turning off the sound temporarily (Muting)	26
Switching the display's brightness	27
Using as a D/A converter	28
Connecting and playing back from a computer (USB-DAC)	29
Connect and playback from a digital device (COAX/OPT1/OPT2)	37
Playing back an iPod	38
Playing an iPod	39
Setting operation mode (Remote iPod mode)	40
Performing repeat playback	41
Performing random playback	41
Charging the iPod	41
Playing a USB memory device	42
Playing files stored on USB memory devices	43
Performing repeat playback	45
Performing random playback	45
Playing audio from devices connected to the AUX connector	46

Settings

Menu map	47
Menu operation	48
AMP Gain	49
Dimmer	49
iPodMode	49
AutoStby	50

Tips

Contents	51
Tips	52
Troubleshooting	53

Appendix

Playing back a USB memory devices	59
Playback order of files	60
About folders and files	61
How to handle media	61
D/A converter	62
Explanation of terms	63
Trademark information	65
Specifications	66
Index	69





Thank you for purchasing this Marantz product.

To ensure proper operation, please read this owner's manual carefully before using the product.

After reading this manual, be sure to keep it for future reference.

Accessories

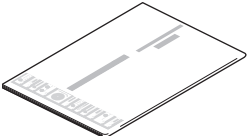
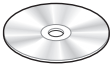
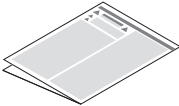
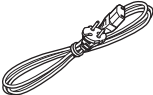
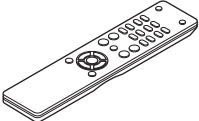
Check that the following parts are supplied with the product.

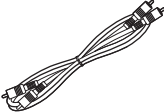
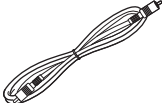
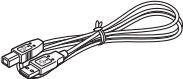
 <p>Quick Start Guide</p>	 <p>Owner's Manual (CD-ROM)</p>	 <p>Safety Instructions</p>	 <p>Power cord</p>
 <p>Remote control unit (RC001HD)</p>	 <p>R03/AAA batteries</p>	 <p>Audio cable</p>	 <p>Remote connector cable</p>
 <p>USB cable</p>			



About the remote control

Inserting the batteries

- 1 Remove the rear lid in the direction of the arrow and remove it.

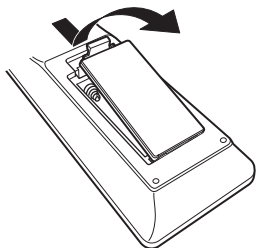

- 2 Insert two batteries correctly into the battery compartment as indicated.

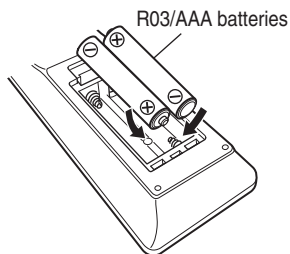

- 3 Put the rear cover back on.

NOTE

- To prevent damage or leakage of battery fluid:
 - Do not use a new battery together with an old one.
 - Do not use two different types of batteries.
- If the battery fluid should leak, carefully wipe the fluid off the inside of the battery compartment and insert new batteries.

Operating range of the remote control unit

Point the remote control unit at the remote sensor when operating it.

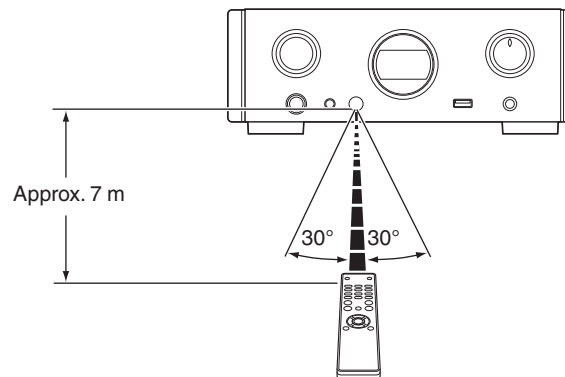

Main features

High quality sound

- **Large-capacitance block capacitor**
A large capacitance 3,300 μF capacitor carefully selected for its acoustic characteristics is incorporated into the power supply circuit.
- **Audiophile-grade film capacitors and electrolytic capacitors**
The unit's features the same audiophile-grade film capacitors and electrolytic capacitors specifically used in top-range models.
- **Low noise amp due differential input HDAM, and equipped with a low distortion filter circuit due to high speed HDAM[®]SA2 delivery amp**
- **Double-layered chassis**
- **High-grade machined analog audio output connectors**
- **High grade headphone circuit**
This unit has a two-amplifier structure based on the design concept of luxury models, comprising a current feedback voltage amplifier using the HDAM[®]SA2 and a feedbackless Darlington power buffer. This allows higher speeds without creating dynamic strain in response to impedance changes in the headphones.

High performance

- **Equipped with a USB-DAC function to support playback of high-resolution sound sources**
This unit supports the playback of high resolution audio formats such as DSD (2.8/5.6 MHz) and PCM files up to 192 kHz/24 bits. It provides high quality playback of high resolution files.
- **DIGITAL AUDIO IN connectors (COAXIAL/OPTICAL)**
You can play back PCM signals up to 192 kHz/24 bits by inputting digital audio signals from an external device into this unit.
- **Plays USB memory devices (MP3/WMA/AAC/WAV) and iPod[®]/iPhone[®]**
You can play back audio files stored on a USB memory device or iPod/iPhone by connecting the USB memory device or iPod/iPhone to the USB port.



- **Peripheral circuitry off function minimizes audio output signal interference**

In order to minimize noise from peripheral circuitry which could interfere with the analog audio signal, this unit is equipped with a peripheral circuitry off function which turns off the display.

- **Equipped with variable audio output connectors**

In addition to the normal fixed audio output connectors, this unit is equipped with variable audio output connectors that cooperate with the volume of this unit. These can be connected to the Power Amplifier to adjust the volume.

- **iPod® auto detect charges your device even after the unit switches to standby mode (☞ p. 20)**

- **Equipped with auto standby mode function that reduces power consumption**



Part names and functions

For buttons not explained here, see the page indicated in parentheses ().

Front panel

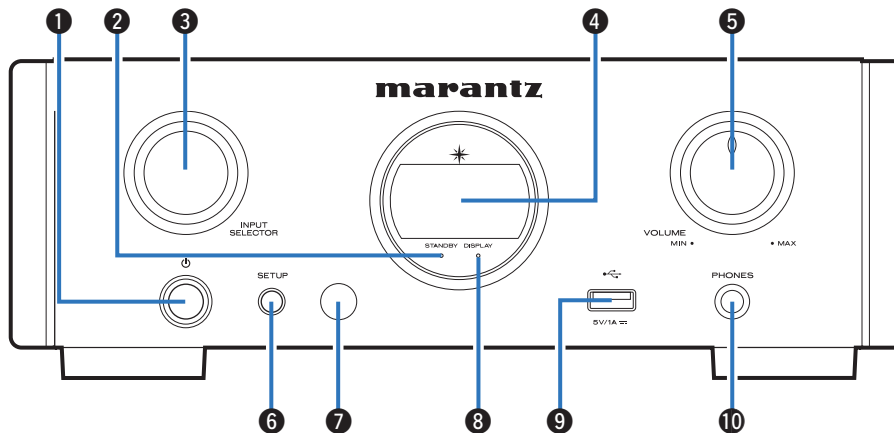

❶ Power operation button (⏻)

This turns the power on/off (standby). (📖 p. 25)

❷ Power indicator (STANDBY)

The standby indicator changes as shown below according to the status of the unit.

- Power on : Off
- Normal standby : Red
- iPod charge standby : Orange

❸ Input source select knob (INPUT SELECTOR)

These select the input source. (📖 p. 26)

❹ Display

Information such as the playback status and input source is displayed here.

❺ VOLUME knob

Adjusts the volume of the headphones and audio output connectors (VARIABLE). (📖 p. 26)



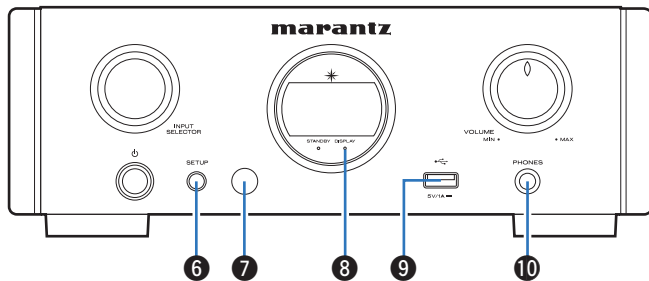

6 SETUP button

Used to set up this unit.

7 Remote control sensor

This receives signals from the remote control unit.

8 DISPLAY OFF indicator

This indicator lights up when the display is off. (👉 p. 27)

9 USB port

Used to connect iPod or USB memory devices. (👉 p. 20)

10 Headphones jack (PHONES)

Used to connect headphones.

NOTE

To prevent hearing loss, do not raise the volume level excessively when using headphones.



Display

The input source name, sampling frequency, setting values and other information are displayed here.

■ D/A converter display

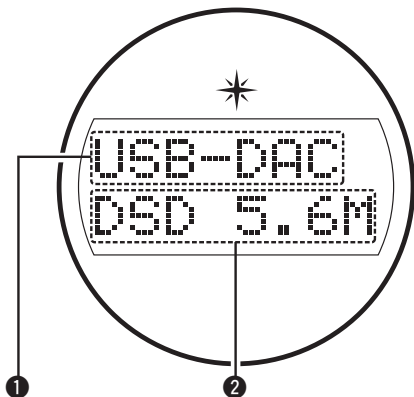

① Input source indicator

This indicator displays the selected input source (USB-DAC/COAX/OPT1/OPT2).

② Sampling frequency display

This indicator displays the sampling frequency of the input audio signal.

■ iPod/USB playback indicator

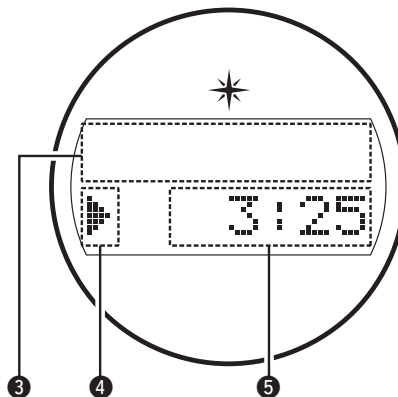

③ Information display

This indicator displays the track information, etc.

④ Playback mode indicators

▶: Displayed during playback.

▬: Displayed during pause.

⑤ Time indicator

This indicator displays the elapsed time of the current track.



Rear panel

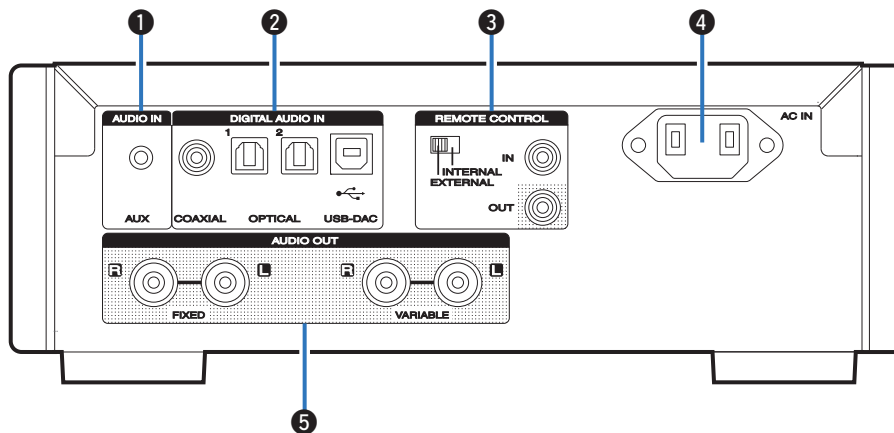

1 AUX INPUT connector

Used to connect a smartphone or portable player with an analog output. (👉 p. 16)

2 DIGITAL AUDIO IN connectors

Used to connect a computer or devices equipped with digital audio output connectors. (👉 p. 17)

3 Remote control input/output connectors (REMOTE CONTROL IN/OUT)

Used to connect to a Marantz amplifier that is compatible with the remote control function. (👉 p. 22)

4 AC inlet (AC IN)

Used to connect the power cord. (👉 p. 23)

5 AUDIO OUT connectors

Used to connect devices equipped with analog audio inputs connectors or an external power amplifier. (👉 p. 16)



Remote control unit

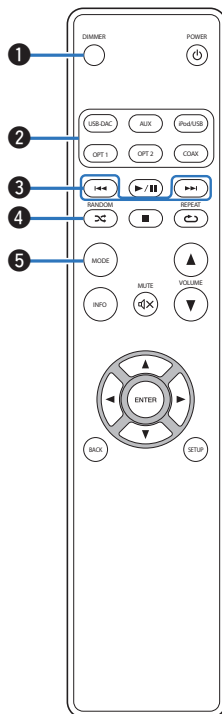

1 DIMMER button

Adjust the display brightness of this unit. (☞ p. 27)

2 Input source select buttons

These select the input source. (☞ p. 26)

3 Skip buttons (⏮, ⏪, ⏩, ⏭)

This skips to the start of the track. Press and hold to fast-forward/fast reverse. (☞ p. 39, 44)

4 RANDOM button (⌘)

Switches the random playback. (☞ p. 41, 45)

5 MODE button

This switches the playback mode. (☞ p. 40, 43)



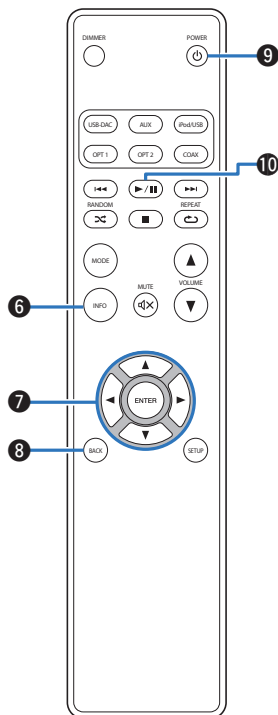

6 Information button (INFO)

This switches display items such as the album name and title name in the playback screen. (☞ p. 39, 44)

7 Cursor buttons (Δ▽◀▶)

These select items. (☞ p. 39, 48)

8 BACK button

Returns to the previous item. (☞ p. 48)

9 POWER button (⏻)

This turns the power on/off (standby). (☞ p. 25)

10 Play/pause button (▶/⏸)

Plays back or pauses a track. (☞ p. 39, 44)



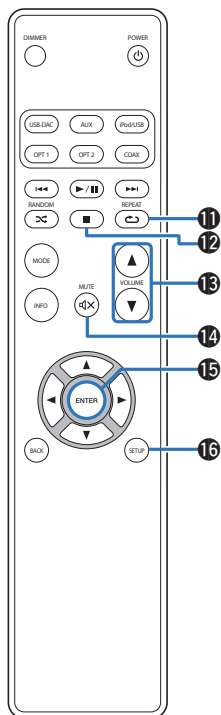

11 REPEAT button (↺)

Switches the repeat playback. (☞ p. 41, 45)

12 Stop button (■)

Stops playback. (☞ p. 39, 44)

13 VOLUME buttons (▲▼)

Adjusts the volume of the headphones and the amplifier connected to the audio output connectors (VARIABLE). (☞ p. 26)

14 MUTE button (⊘)

This mutes the output audio. (☞ p. 26)

15 ENTER button

This determines the selection. (☞ p. 39, 48)

16 SETUP button

The setting menu is displayed on the display. (☞ p. 48)



■ Contents







Connecting an amplifier	16
Connecting to a device with digital audio output connectors	17
Connecting a PC or Mac	18
Connecting a smartphone or portable player	19
Connecting an iPod or USB memory device to the USB port	20
Connecting devices with remote control connectors	22
Connecting the power cord	23

NOTE

- Do not plug in the power cord until all connections have been completed.
- Do not bundle power cords with connection cables. Doing so can result in humming or noise.

■ Cables used for connections

Provide necessary cables according to the devices you want to connect.

Audio cable (supplied)	
Remote connector cable (supplied)	
Optical cable (Sold separately)	
Coaxial digital cable (Sold separately)	
USB cable (supplied)	
Stereo mini plug cable (sold separately)	



Connecting an amplifier

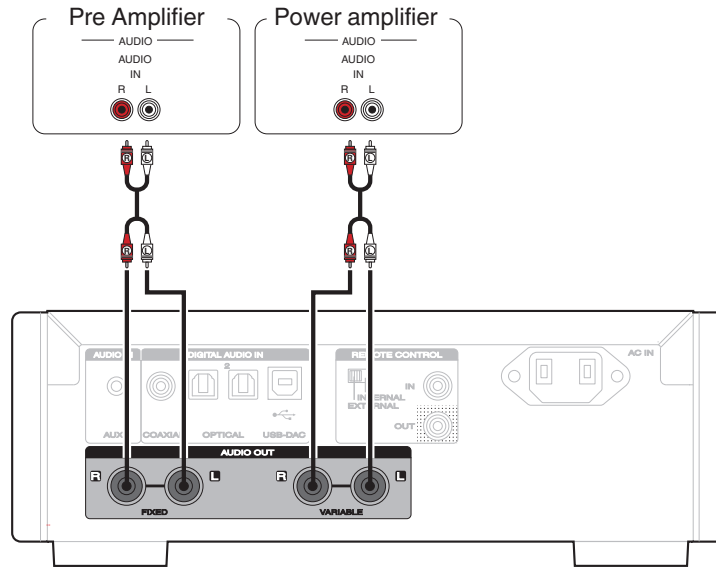

NOTE

Do not connect a power amplifier to the FIXED connectors. Connecting a power amplifier may cause damage to the speakers.



Connecting to a device with digital audio output connectors

Use this connection to input digital audio signals to this unit, and convert the signals for playback using the D/A converter of this unit. (☞ p. 37)

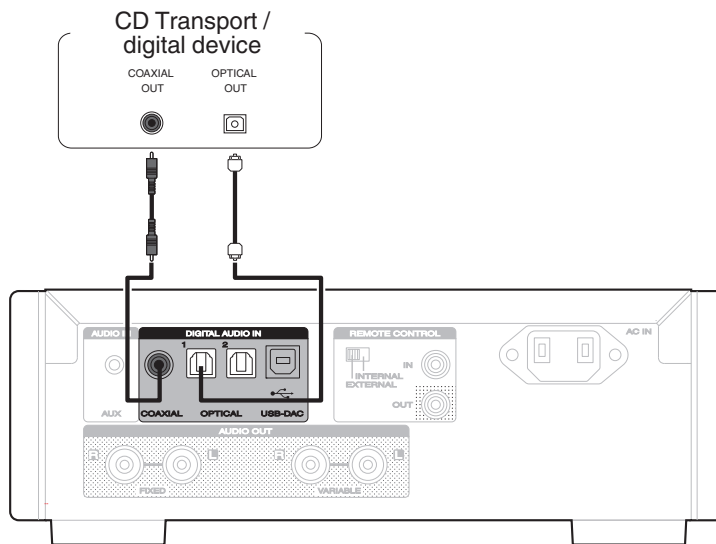

NOTE

- Linear PCM signals with a sampling frequency of 32 kHz, 44.1 kHz, 48 kHz, 64 kHz, 88.2 kHz, 96 kHz, 176.4 kHz, or 192 kHz can be input into this device.
- Do not input non-PCM signals, such as DTS and AAC. This causes noise and could damage the speakers.



Connecting a PC or Mac

By connecting a computer to the USB port (USB-DAC) on the rear panel of this unit using a commercially available USB cable (supplied), this unit can be used as a D/A converter. (🔗 p. 29)

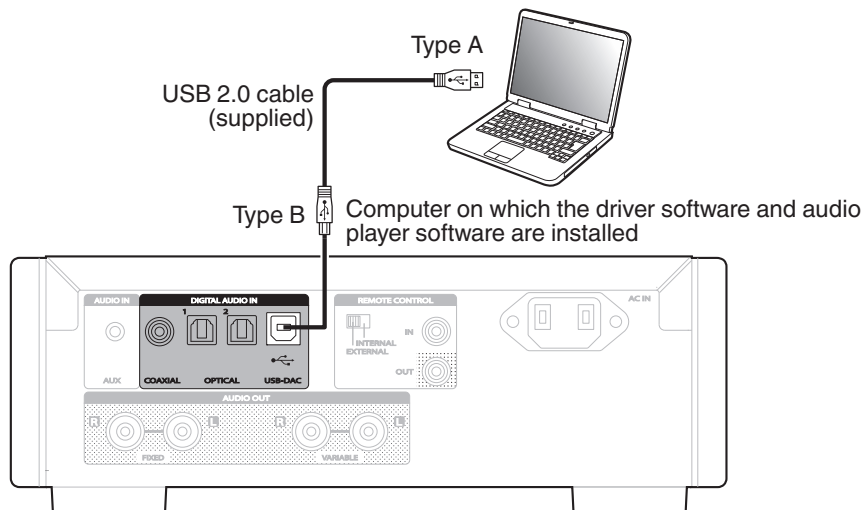

- Install the dedicated driver software on the computer to enable communication between the computer and this unit in order to playback high-resolution sound source (DSD signal or 192 kHz/24 bit PCM signal) audio available on the internet. (🔗 p. 29)
- Download the driver software from the HD-DAC1 page of the Marantz website.

NOTE

Use a cable that is 3 m or less to connect to the computer.



Connecting a smartphone or portable player

Use this connection to input analog audio signals to this unit and play them back through the amplifier of this unit.

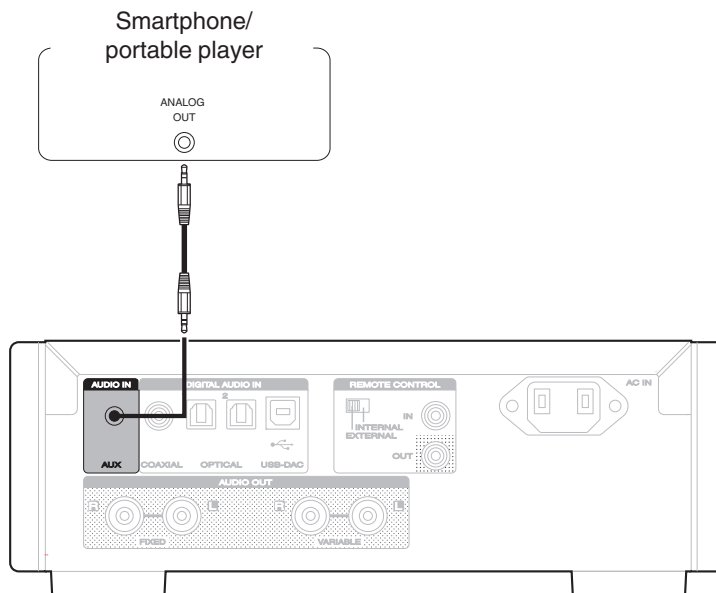

Connecting an iPod or USB memory device to the USB port

You can enjoy music stored on an iPod/iPhone or USB memory device.

- To connect an iPod/iPhone to this unit, use the USB adapter cable that was supplied with the iPod/iPhone.
- For operating instructions see “Playing an iPod” (🔗 p. 39) or “Playing files stored on USB memory devices” (🔗 p. 43).

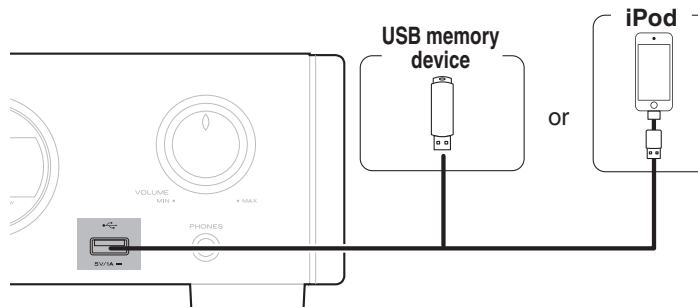

Marantz does not guarantee that all USB memory devices will operate or receive power. When using a portable USB hard disk drive (HDD) which came with an AC adapter, use that device's supplied AC adapter.

NOTE

- USB memory devices will not work via a USB hub.
- Playback is not possible when connected via the front panel's USB port. Connection to a computer is possible via the digital input USB-DAC port (Type B) on the rear panel.
- Do not use an extension cable when connecting a USB memory device. This may cause radio interference with other devices.



■ Supported iPod/iPhone models

• iPod classic



iPod classic
80GB



iPod classic
160GB (2007)



iPod classic
160GB (2009)

• iPod nano



iPod nano
3rd generation
(video)
4GB 8GB



iPod nano
4th generation (video)
8GB 16GB



iPod nano
5th generation (video camera)
8GB 16GB



iPod nano
6th generation
8GB 16GB



iPod nano
7th generation
16GB

• iPod touch



iPod touch
2nd generation
8GB 16GB 32GB



iPod touch
3rd generation
32GB 64GB



iPod touch
4th generation
8GB 16GB 32GB 64GB



iPod touch
5th generation
16GB 32GB 64GB

• iPhone



iPhone 3G
8GB 16GB



iPhone 3GS
16GB 32GB



iPhone 4
8GB 16GB 32GB



iPhone 4S
16GB 32GB 64GB



iPhone 5
iPhone 5c iPhone 5s
16GB 32GB 64GB



REMOTE CONTROL jack

When you use this unit connected to a Marantz amplifier, this unit receives operation signals sent from the amplifier and operates accordingly. Next, configure the “Connections” and “Settings”.

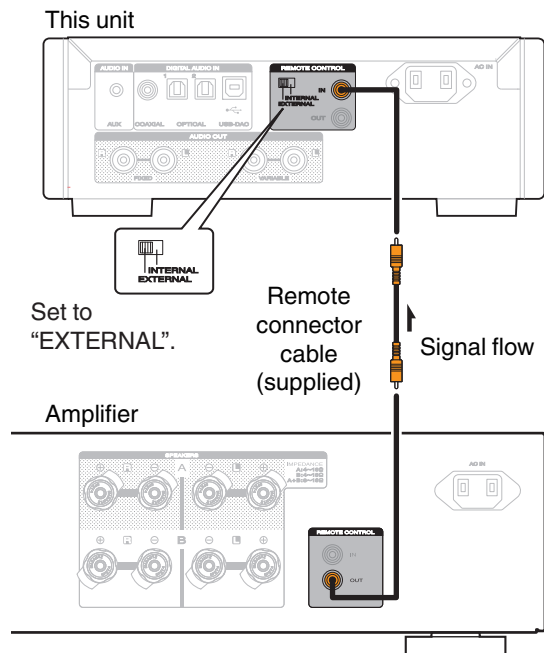

Connection

Use the supplied remote connector cable to connect the REMOTE CONTROL IN connector of this unit to REMOTE CONTROL OUT connector of the amplifier.

Setting

Turn the EXTERNAL/INTERNAL switch on the unit to “EXTERNAL”.

- This setting will disable remote sensor reception of this unit.
- To operate the unit, point the remote control at the remote sensor of the amplifier.



To use this unit by itself without connecting an amplifier, turn the switch to “INTERNAL”.



Connecting the power cord

Wait until all connections have been completed before connecting the power cord.

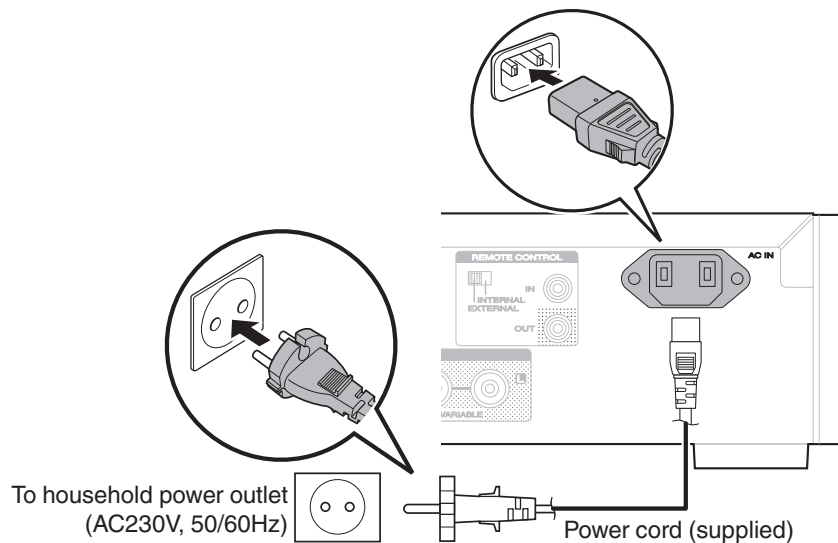

■ Contents

Turning the power on	25	Using as a D/A converter (USB-DAC)	28
Selecting the input source	26	Playing an iPod	38
Adjusting the volume	26	Playing a USB memory device	42
Turning off the sound temporarily (Muting)	26	Playing audio from devices connected to the AUX connector	46
Switching the display's brightness	27		



Basic operation

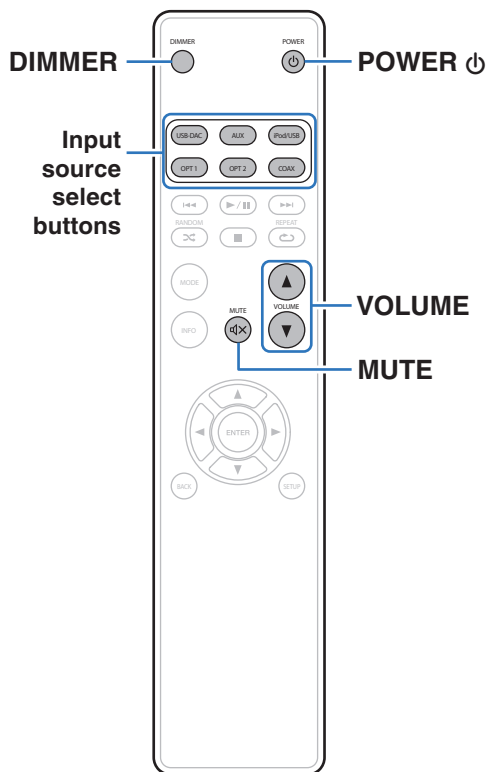

Turning the power on

- 1 Press **POWER**  to turn on power to the unit.
The power indicator turns off.



You can also switch the power to standby by pressing  on the main unit.

Switching the power to standby

- 1 Press **POWER** .
- The unit switches to standby mode.

NOTE

Power continues to be supplied to some of the circuitry even when the power is in the standby mode. When leaving home for long periods of time or when going on vacation, unplug the power cord from the power outlet.



Selecting the input source

- 1 Press the input source select button to be played back.

USB-DAC:	Plays back audio files on the computer.
COAX:	Plays back the device connected to the COAXIAL connector.
OPT1:	Plays back the device connected to the OPTICAL 1 connector.
OPT2:	Plays back the device connected to the OPTICAL 2 connector.
iPod/USB:	Plays back an iPod or USB memory device.
AUX:	Plays back analog audio signals input to the AUX connector.



You can also select the input source by turning INPUT SELECTOR on the main unit.

Adjusting the volume

- 1 Press **VOLUME ▲▼** to adjust the volume.



You can also adjust the master volume by turning VOLUME on the main unit.

Turning off the sound temporarily (Muting)

Mutes audio output from the headphones and audio output connectors (VARIABLE).

- 1 Press **MUTE** .

“MUTE ON” appears in the display.



To cancel mute, press **MUTE**  again.



Switching the display's brightness

The display brightness can be adjusted between four levels. Switching the display off reduces a source of noise that affects sound quality, enabling higher sound quality playback.

1 Press DIMMER.



- When the display is turned off, the DISPLAY OFF indicator lights.
- The brightness of the display can also be switched in the setting menu on the display of the main unit.



Using as a D/A converter

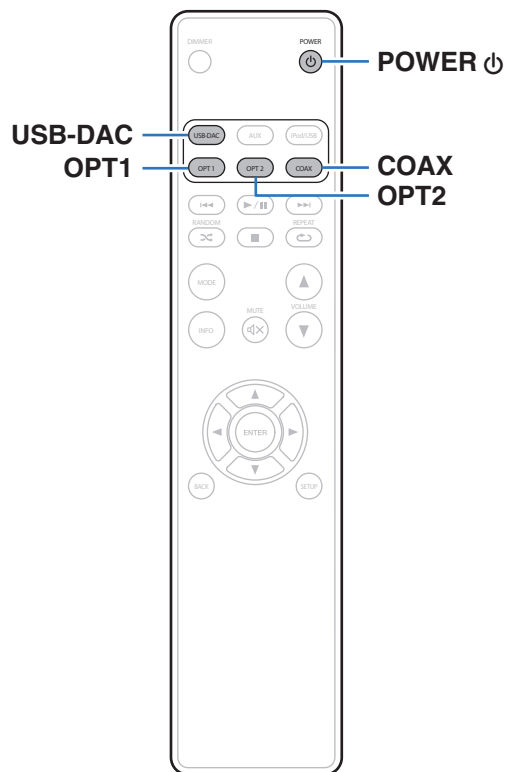

Digital audio signals input from an external device or computer into this unit can be converted and output as analog signals using this unit's D/A converter. (D/A converter function)

- **DSD is a registered trademark.**
- **Microsoft, Windows Vista, Windows 7 and Windows 8 are either registered trademarks or trademarks of Microsoft Corporation in the United States and/or other countries.**
- **Apple, Macintosh and Mac OS are trademarks of Apple Inc., registered in the U.S. and other countries.**



Connecting and playing back from a computer (USB-DAC)

You can enjoy high-quality audio playback from the D/A converter built in to this unit by inputting PCM signal or DSD signal music files into this unit from a computer via USB connection.

- Before USB connecting this unit to your computer, install the driver software in your computer.
- Drivers do not need to be installed for Mac OS.
- Also, you can use whichever commercially available or downloadable player software you like to playback files on your computer.

■ Computer (recommended system)

OS

- Windows® Vista, Windows 7 or Windows 8/8.1
- Mac OS X 10.6.3 or later

USB

- USB 2.0: USB High speed/USB Audio Class Ver.2.0

Windows OS Installing the dedicated driver (🔗 p. 29)

Mac OS Audio Device Settings (🔗 p. 35)

■ Installing the dedicated driver (Windows OS only)

□ Installing the driver software

- 1 Disconnect the USB cable between your PC and the unit.**
 - The driver software cannot be installed correctly if your PC is connected to the unit by a USB cable.
 - If the unit and your computer are connected by a USB cable and the computer is switched on before installation, disconnect the USB and restart the computer.
- 2 Download the dedicated driver from the “Download” section of the HD-DAC1 page of the Marantz website onto your PC.**
- 3 Unzip the downloaded file, select the 32-bit or 64-bit exe file that matches your Windows operating system, and double-click the file.**



4 Install the driver.

- ① Select the language to use for the installation.
- ② Click “OK”.



- ③ The wizard menu is displayed. Click “Next”.

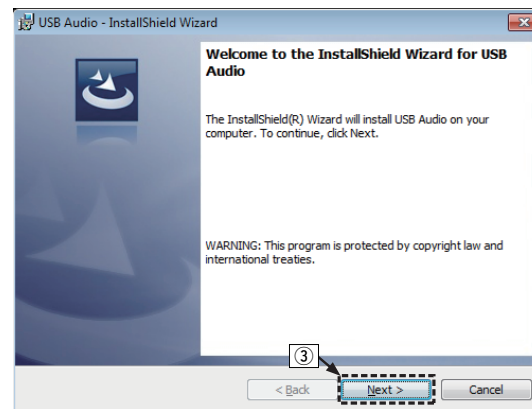

- ④ Read the Software Licensing Agreement, and click “I accept the terms in the license agreement”.
- ⑤ Click “Next”.



- ⑥ Click “Install” on the installation start dialog.

 - The installation starts. Do not perform any operation on the PC until the installation is completed.

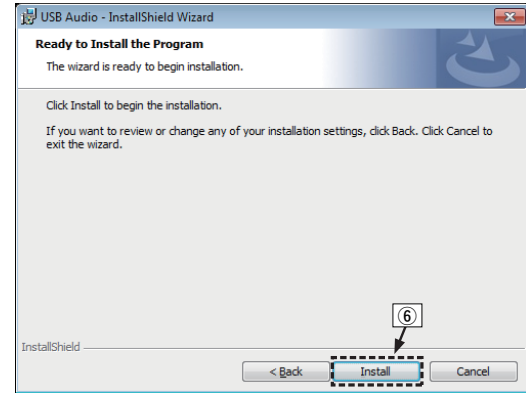

- ⑦ In the Windows security dialog, select “Always trust software from “DandM Holdings Inc.””.
- ⑧ Click “Install”.



- ⑨ When the installation is completed, click “Finish”.

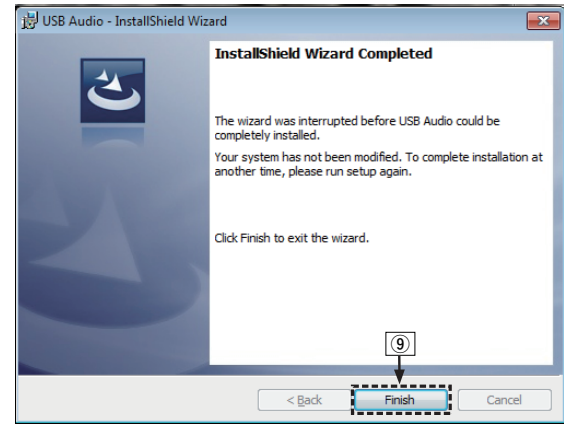

5 With the unit power off, connect the unit and PC using a USB cable (supplied).

- For the connection procedure, refer to the “Connecting a PC or Mac” (🔗 p. 18) section.



6 Press POWER .

- When the unit power is turned on, the PC automatically finds and connects to the unit.

7 Press the input source select button (USB-DAC) to switch the input source to “USB-DAC”.

8 Checking the installed driver.

- ① Click the “Start” button and click “Control Panel” on the PC.
 - The control panel setting list is displayed.
- ② Click the “Sound” icon.
 - The sound menu window is displayed.
- ③ Check that there is a checkmark next to “Default Device” under in “Digital Audio Interface” of the “Playback” tab.
 - When there is a checkmark for a different device, click “Marantz USB Audio” and “Set Default”.

9 Checking audio output.

Outputs a TEST signal from the PC and checks the audio output from the USB-DAC function.

- ① Select “Digital Audio Interface” and click “Properties”.
 - The Digital Audio Interface Properties window is displayed.

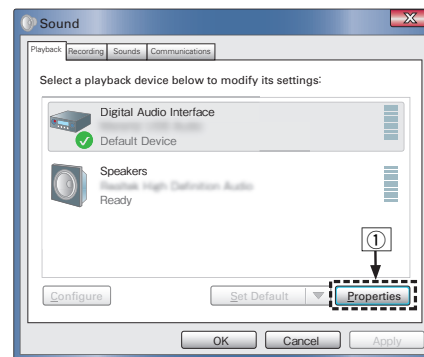

- ② Click the “Advanced” tab.
 - ③ Select the sampling rate and bit rate to be applied to the D/A converter.
 - It is recommended that “2 channel, 24 bit, 192000 Hz (Studio Quality)” is selected.
 - ④ Click “Apply”.
 - ⑤ Click “Test”.
- Check that audio from this unit is output from the PC.

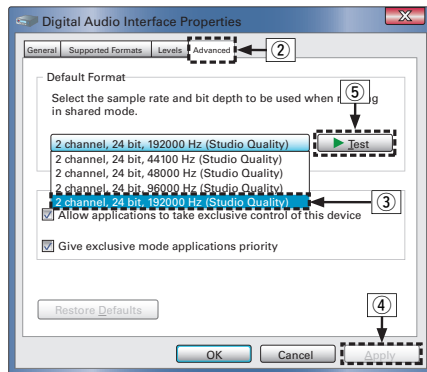
**NOTE**

- The dedicated driver must be installed in the PC before this unit is connected to a PC. Operation will not occur correctly if connected to the PC before the dedicated driver has been installed. Moreover, if the PC is running Windows XP as its OS, the PC's speed will decrease significantly, and a PC restart may be required.
- Operation may fail in some PC hardware and software configurations.



■ Audio Device Settings (Mac OS X only)

- ① Move the cursor to “Go” on the computer screen, and then click “Utilities”.
 - The utility list is displayed.
- ② Double-click “Audio MIDI Setup”.
 - The “Audio Devices” window is displayed.
- ③ Check that “Use this device for sound output” is checked in “HD-DAC1”.
 - If a different device is checked, select and “Secondary click” on “HD-DAC1”, and then select “Use this device for sound output”.

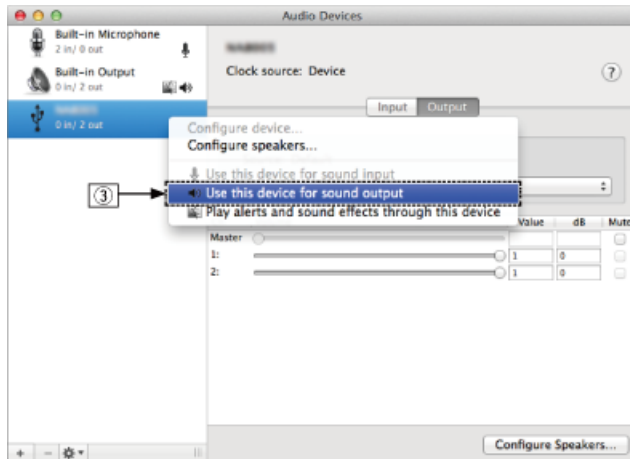

- ④ Select the “HD-DAC1” format.
 - It is normally recommended to set the format to “192000.0 Hz” and “2ch-24 bit Interger”.

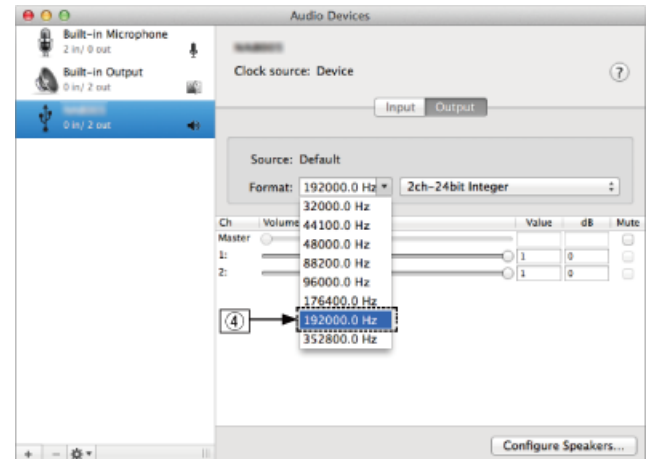

- ⑤ Click “Quit Audio MIDI Setup”.



Connect and playback from a digital device (COAX/OPT1/OPT2)

1 Press COAX, OPT1 or OPT2 to switch the input source to “COAX”, “OPT1” or “OPT2”.

The digital audio signal that is being input is shown as follows in the display.

“COAX
xxxxk” or “OPT1
xxxxk” or “OPT2
xxxxk”

(xxxx is the sampling frequency.)

- If the sampling frequency cannot be detected, “Unlocked” will be displayed.
- “Unsupported” is displayed when audio signals that are not supported by this unit are input.

■ Files that can be played back

See “D/A converter” (📖 p. 62).

NOTE

- Do not input non-PCM signals, such as Dolby Digital, and DTS. This causes noise and could damage the speakers.
- If the sampling frequency switches, such as from A mode to B mode in a CS broadcast, muting may operate for 1 – 2 seconds, cutting the sound.



Playing an iPod

- 1 Press iPod/USB to switch the input source to “iPod/USB”.
- 2 Connect the iPod to the USB port. (👉 p. 20)
“Direct iPod” is displayed on the display of this unit.
- 3 Operate iPod itself directly while seeing the iPod screen to play back music.



The iPod display modes include “Direct iPod” and “Remote iPod”. By default, “Direct iPod”, where you directly operate the iPod itself while looking at the iPod screen, is set.

NOTE

- Marantz will accept no responsibility whatsoever for any loss of iPod data.
- Depending on the type of iPod and the software version, some functions may not operate.

■ iPod operation

Operation buttons	Function
MODE	Setting iPod operation mode <ul style="list-style-type: none"> • Switching between “Direct iPod” or “Remote iPod” mode.
INFO	Text information display <ul style="list-style-type: none"> • Text information recorded on the media is displayed.
△ ▽ ◀ ▶	Select the item
⏮, ⏭	Skip search (cue)
⏮, ⏭ (Press and hold)	Manual search (fast-reverse/fast-forward)
▶/⏸	Playback / Pause
■	Stop
REPEAT ↺	Repeat playback (👉 p. 41) <ul style="list-style-type: none"> • Switching between All-track repeat and Single-track repeat.
RANDOM ⤵	Shuffle playback (👉 p. 41)



Setting operation mode (Remote iPod mode)

In this mode, various lists and screens during playback on the iPod are displayed on this unit.

This section describes the steps up to playing back tracks on the iPod in "Remote iPod".

1 Press MODE.

"Remote iPod" is displayed on the display of this unit.

2 Use Δ / ∇ to select the file to be played, then press ENTER.

Playback starts.

Operation mode		Direct iPod	Remote iPod
Playable files	Music file	✓	✓
	Video file	*	
Active buttons	Remote control unit (This unit)	✓	✓
	iPod	✓	

* Only the sound is played.

■ Switching the display

During playback, press INFO.

- This switches between the title name, artist name, album name and track number.



Performing repeat playback

1 Press REPEAT .

- The current repeat play mode is indicated in the display first.
- The repeat playback mode is switched each time the button is pressed.

Repeat Off (Repeat Off):	Repeat playback mode is canceled.
Repeat One (Single-track repeat):	A file being played is played repeatedly.
Repeat All (All-track repeat):	All files in the folder currently being played are played repeatedly.

Performing random playback

1 Press RANDOM .

- The current random play mode is indicated in the display first.
- The random playback mode is switched each time the button is pressed.

Random Off (Random off):	Disable random playback.
Random On (Random on):	Randomly play back all tracks in the current playback folder.

Charging the iPod

You can charge an iPod or iPhone when the input source is switched to “iPod/USB” and the iPod or iPhone is connected to the USB port.

- If the unit enters power standby mode while the iPod/iPhone is charging, the unit will switch to standby charging mode, and the iPod/iPhone will continue to be charged. When in standby charging mode, the power display light turns orange. When charging is completed, the unit enters normal power standby mode and the power indicator turns red.



Playing a USB memory device

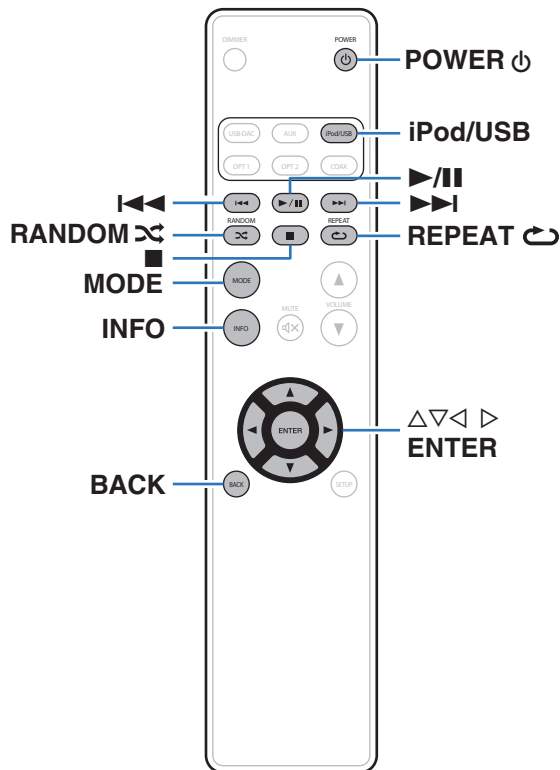

- Playing back music stored on a USB memory device.
- Only USB memory devices conforming to mass storage class standards can be played on this unit.
- This unit is compatible with USB memory devices in “FAT16” or “FAT32” format.
- This unit can play back the following files.
 - WMA
 - MP3
 - WAV
 - AAC



Playing files stored on USB memory devices

- 1 Press iPod/USB to switch the input source to “iPod/USB”.**
- 2 Connect the USB memory device to the USB port.**
( p. 20)
- 3 Press “MODE” to select “Folder” or “All”.**
 - About the display**
 - **When “Folder” is selected**
All the files in the selected folder are played.
 - **When “All” is selected**
After the selected folder and files are played, all the files in all the folders are played.
- 4 Use $\Delta\nabla$ to select the file or folder, then press ENTER.**
- 5 Use $\Delta\nabla$ to select the file, then press ENTER.**
Playback starts.

■ Resume function

This unit stores the point at which playback of a file was stopped.

- Resume playback works even if the USB memory device is disconnected and then reconnected. However, if a different USB memory device is connected, the resume information for the previous USB memory device is deleted.
- The resume information may be deleted when the USB memory device is removed and files are added or deleted.
- Press  while playback is stopped to delete the resume information. “Resume Off” is displayed.

NOTE

- Do not remove the USB memory device from the unit when the USB memory communication indicator is flashing. Doing so may damage the USB memory device, or may corrupt the files recorded on the USB memory device.
- Note that Marantz will accept no responsibility whatsoever for any problems arising with the data on a USB memory device when using this unit in conjunction with the USB memory device.



■ USB operation

Operation buttons	Function
MODE	Switch to Folder playback mode <ul style="list-style-type: none"> Switching between “Folder” or “All” mode.
INFO	Text information display <ul style="list-style-type: none"> Text information recorded on the media is displayed.
	Select the item
	Skip search (cue)
(Press and hold)	Manual search (fast-reverse/fast-forward)
	Playback / Pause
	Stop
REPEAT	Repeat playback (p. 45) <ul style="list-style-type: none"> Switching between All-track repeat and Single-track repeat.
RANDOM	Random playback (p. 45)

■ Files that can be played back

See “Playing back a USB memory devices” (p. 59).

■ Switching the display

During playback, press INFO.

- This switches between the file name, title name, artist name, album name and file number.
- While a WAV file is being played back, only the file name is displayed.
- The player can display the following characters:

ABCDEFGHIJKLMNOPQRSTUVWXYZ

abcdefghijklmnopqrstuvwxyz

0123456789

!"#\$%&:;<?@[_ ` | { ~ ^ ' (* + , - . / = (space)



Performing repeat playback

1 Press REPEAT .

- The current repeat play mode is indicated in the display first.
- The repeat playback mode is switched each time the button is pressed.

Repeat Off (Repeat Off):	Repeat playback mode is canceled.
Repeat One (Single-track repeat):	A file being played is played repeatedly.
Repeat All (All-track repeat):	All tracks in the playback range set by MODE (Folder/All) are played back repeatedly.

Performing random playback

1 Press RANDOM .

- The current random play mode is indicated in the display first.
- The random playback mode is switched each time the button is pressed.

Random Off (Random off):	Disable random playback.
Random On (Random on):	All tracks in the playback range set by MODE (Folder/All) are played back in random order.



Playing audio from devices connected to the AUX connector

You can connect a smartphone or portable player to the AUX connector of this unit and play back audio.

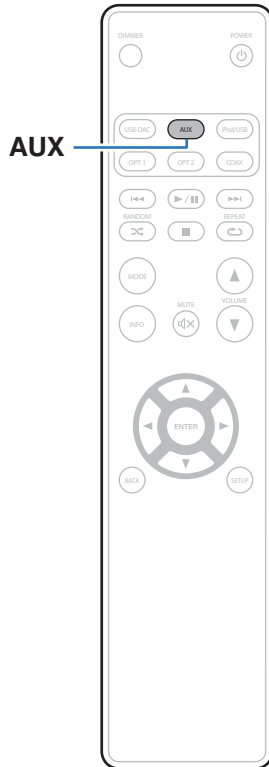

- 1 Press AUX to switch the input source to “AUX”.**
- 2 Connect a smartphone or portable player to the AUX connector of this unit. (See p. 19)**
- 3 Play the component connected to this unit.**



Menu map

By default, this unit has recommended settings defined. You can customize this unit based on your existing system and your preferences.

Setting items	Description	Page
AMP Gain	Set the gain of the headphone amplifier.	49
Dimmer*	This switches the brightness of the display.	49
iPodMode*	Set whether to operate the iPod from this unit or on the iPod.	49
AutoStby	Sets whether to automatically switch the unit to the standby mode when the unit remains in the stop mode for more than 30 minutes.	50

* Displayed when SETUP is pressed on this unit.



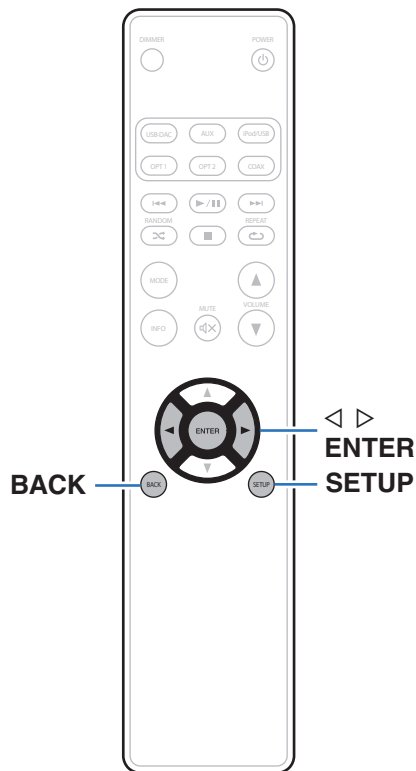

Menu operation

- 1 Press SETUP to select the menu to be set.**
Each time you press SETUP, the setting item changes.
- 2 Use <|> to change to desired setting.**
 - You can also change the setting by turning INPUT SELECTOR on the main unit.
- 3 Press SETUP or ENTER to return to the normal display.**
 - The display returns to the normal display if no operations are performed for 5 seconds after configuring settings on the main unit.
 - To return to the previous item, press BACK.



AMP Gain

Set the gain of the headphone amplifier. Set this according to the impedance of the connected headphones. It is recommended that this is set on the “Low” side if the headphones have low impedance and on the “High” side if they have high impedance.

Low (Default):	Set the gain of the headphone amplifier to “Low”.
Mid:	Set the gain of the headphone amplifier to “Mid”.
High:	Set the gain of the headphone amplifier to “High”.

NOTE

The headphone volume varies depending on the “AMP Gain” setting. Decrease the volume or mute the audio first if changing this setting while listening to audio.

Dimmer

This switches the brightness of the display.

Off:	Turns the display off.
Dark:	Very low display brightness.
Dim:	Reduced display brightness.
Bright (Default):	Normal display brightness.



You can also adjust the display by pressing DIMMER on the remote control unit.

iPodMode

Set whether to operate the iPod from this unit or on the iPod.

Direct (Default):	Operate the iPod on the iPod itself.
Remote:	Operate the iPod from this unit and the remote control unit.



Operation mode can also be switched by pressing MODE on the remote control unit.



AutoStby

When this unit is in the stop state and there is no input signal and operation for 30 minutes, it automatically enters the standby mode.

On
(Default): Enable Auto Standby mode.

Off: Disable Auto Standby mode.



When iPod is being charged, this unit enters the power standby mode after charging.



Contents

■ Tips

I want to enjoy analog output audio at higher quality	52
I want to playback just the specified folder	52
I want to delete the resume information for playback of a USB memory device	52
I want to display the title, etc. of the file currently playing back on the iPod on this unit's display	51
I want to playback WAV files	52
I want to adjust the volume with the volume controls of this unit when the Power Amplifier is connected	52

■ Troubleshooting

Power does not turn on / Power is turned off	53
Operations cannot be performed through the remote control unit	54
Display on this unit shows nothing	51
No sound comes out	51
Sound is interrupted or noise occurs	51
PC or Mac files cannot be played back	56
Audio from digital devices cannot be played back (Coaxial/Optical)	56
iPod cannot be played back	56
USB memory devices cannot be played back	57
File names on the iPod/USB memory device are not displayed properly	58



Tips

I want to enjoy analog output audio at higher quality

- Press the DIMMER button to turn the display off. (👉 p. 27)

I want to playback just the specified folder

- Press the MODE button to set the playback mode to “Folder”. (👉 p. 43)

I want to delete the resume information for playback of a USB memory device

- In the stop mode, press the ■ button.

I want to display the title, etc. of the file currently playing back on the iPod on this unit's display

- Press the MODE button to set Remote iPod mode. (👉 p. 40)

I want to playback WAV files

- This unit can playback WAV files that are stored on a USB memory device. (👉 p. 42)

I want to adjust the volume with the volume controls of this unit when the Power Amplifier is connected

- Connect the Power Amplifier to the audio output connectors (VARIABLE). (👉 p. 16)





Troubleshooting

1. Are the connections correct?
2. Is the set being operated as described in the owner's manual?
3. Are the other devices operating properly?

If this unit does not operate properly, check the items listed in the table below.

Should the problem persist, there may be a malfunction. In this case, disconnect the power immediately and contact your store of purchase.

■ Power does not turn on / Power is turned off

Symptom	Cause / Solution	Page
Power is not turned on.	• Check whether the power plug is correctly inserted into the power outlet.	<u>23</u>
	• This unit is in standby mode. Press  on the unit or POWER  on the remote control.	<u>25</u>
Power automatically turns off.	• The Auto Standby mode is on. The Auto Standby mode switches the unit to standby mode when the unit is not operated for approximately 30 minutes. To disable Auto Standby mode, set "AutoStby" on the menu to "Off".	<u>50</u>



■ Operations cannot be performed through the remote control unit

Symptom	Cause / Solution	Page
Operations cannot be performed through the remote control unit.	• Batteries are worn out. Replace with new batteries.	5
	• Operate the remote control unit within a distance of about 7 m from this unit and at an angle of within 30°.	5
	• Remove any obstacle between this unit and the remote control unit.	—
	• Insert the batteries in the proper direction, checking the ⊕ and ⊖ marks.	5
	• The set's remote control sensor is exposed to strong light (direct sunlight, inverter type fluorescent bulb light, etc.). Move the set to a place in which the remote control sensor will not be exposed to strong light.	—
	• When using a 3D video device, the remote control unit of this unit may not function due to effects of infrared communications between units (such as TV and glasses for 3D viewing). In this case, adjust the direction of units with the 3D communications function and their distance to ensure they do not affect operations from the remote control unit of this unit.	—
	• When using this unit independently, set the switch to "INTERNAL".	22

■ Display on this unit shows nothing

Symptom	Cause / Solution	Page
Display is off.	• Press DIMMER, and change the setting to anything other than off.	27



■ No sound comes out

Symptom	Cause / Solution	Page
No sound is produced. Or sound is distorted.	• Check the connections for all devices.	<u>15</u>
	• Insert connection cables all the way in.	—
	• Check that input connectors and output connectors are not reversely connected.	—
	• Check cables for damage.	—
	• Check the amplifier's functions and controls and adjust as necessary.	—
	• Check that a proper input source is selected.	<u>26</u>
	• The volume is set to the minimum level. Adjust the volume to a suitable level.	<u>26</u>
	• Cancel the mute mode.	<u>26</u>
	• Switch "AMP Gain" to "Mid" or "High" if using headphones with high impedance or low sensitivity.	—
When the volume is increased, sound from the audio output connectors (VARIABLE) is distorted.	• If the "AMP Gain" setting is "High" or "Mid", switch it to "Low".	<u>49</u>

■ Sound is interrupted or noise occurs

Symptom	Cause / Solution	Page
Sound is interrupted during playback of tracks saved on a computer.	• Do not start applications other than the player software while playing music on your computer.	—



■ PC or Mac files cannot be played back

Symptom	Cause / Solution	Page
"Unlocked" is displayed.	<ul style="list-style-type: none"> When digital audio signals cannot be detected properly, "Unlocked" is displayed. 	36
"Unsupported" is displayed.	<ul style="list-style-type: none"> "Unsupported" is displayed when audio signals that are not supported by this unit are input. Check the settings on your computer or player software. 	36
	<ul style="list-style-type: none"> If the computer you use is "Mac OS", please check if the "HD-DAC1" format is set below "192000.0 Hz" using the "Audio MIDI Setup". 	—

■ Audio from digital devices cannot be played back (Coaxial/Optical)

Symptom	Cause / Solution	Page
"Unlocked" is displayed.	<ul style="list-style-type: none"> When digital audio signals cannot be detected properly, "Unlocked" is displayed. 	37
"Unsupported" is displayed.	<ul style="list-style-type: none"> "Unsupported" is displayed when audio signals that are not supported by this unit are input. Check the audio output signal format from your digital device. 	37

■ iPod cannot be played back

Symptom	Cause / Solution	Page
iPod cannot be connected or "Error 5" is displayed.	<ul style="list-style-type: none"> When using iPod by connecting it to the USB port, some iPod variations are not supported. 	21
	<ul style="list-style-type: none"> When iPod is connected by using a USB cable other than the genuine cable, iPod may not be recognized. Use a genuine USB cable. 	—



■ USB memory devices cannot be played back

Symptom	Cause / Solution	Page
"No USB Device", "Error 1" or "Error 2" is displayed.	• This unit may not recognize the USB memory device due to poor connection, etc. Make sure that the connection is made properly by taking actions such as disconnecting and reconnecting the USB memory device.	<u>20</u>
	• Mass storage class compatible USB memory devices are supported.	—
	• This unit does not support a connection through a USB hub. Connect the USB memory device directly to the USB port.	—
	• The USB memory device must be formatted to FAT16 or FAT32.	—
	• Not all USB memory devices are guaranteed to work. Some USB memory devices are not recognized. When using a type of portable hard disc drive compatible with the USB connection that requires power from an AC adapter, use the AC adapter that came with the drive.	—
Files on the USB memory device are not displayed or "Error 3" is displayed.	• Files of a type not supported by this unit are not displayed.	<u>42</u>
	• This unit can display a file structure with up to 8 levels, up to 700 folders and up to 65,535 files in total. Modify the folder structure of the USB memory device.	—
	• When multiple partitions exist on the USB memory device, only files on the first partition are displayed.	—
Files on a USB memory device cannot be played.	• Files are created in a format that is not supported by this unit. Check the formats supported by this unit.	<u>42</u>
	• Files that are copyright protected cannot be played on this unit.	—
	• If a file is unplayable, "Error 5" is displayed and the next file is played.	—



■ File names on the iPod/USB memory device are not displayed properly

Symptom	Cause / Solution	Page
The file names are not displayed properly ("...", etc.).	<ul style="list-style-type: none">Characters that cannot be displayed have been used. On this unit, characters that cannot be displayed are replaced with a "." (period).	—

■ Sound is distorted when AUX is used

Symptom	Cause / Solution	Page
Sound is distorted when AUX is used.	<ul style="list-style-type: none">Turn down the volume of the playback device connected to the AUX connector.	—



Playing back a USB memory devices

■ USB-compatible file systems

FAT16 or FAT32

- If the USB memory device is divided into multiple partitions, only the top drive can be selected.

■ Tag data

ID3-TAG (Ver.1.x and 2.x)

WMA-TAG

AAC-TAG

(The title, artist, and album tag data are supported)

■ Compatible formats

Playable files (Extension)	File specification
MP3 (.mp3)	<ul style="list-style-type: none"> • Sampling frequency : 32 / 44.1 / 48 kHz • Bit rate : 32 kbps to 320 kbps • File format : MPEG1 Audio Layer 3
WMA (.wma)	<ul style="list-style-type: none"> • Sampling frequency : 32 / 44.1 / 48 kHz • Bit rate : 48 kbps to 320 kbps • File format : Windows Media Audio
AAC (.m4a)	<ul style="list-style-type: none"> • Sampling frequency : 32 / 44.1 / 48 kHz • Bit rate : 64 kbps to 192 kbps • File format : Advanced Audio Codec
Linear PCM (.wav)	<ul style="list-style-type: none"> • Sampling frequency : 32 / 44.1 / 48 kHz • Bit length: 16 bit • File format : Linear PCM

■ Maximum number of playable files and folders

Number of files : 65,535

Number of folders : 700





- This unit can only play music files that are not copyright protected.
- Content downloaded from pay sites on the Internet are copyright protected. Also, files encoded in WMA format when ripped from a CD, etc., on a computer may be copyright protected, depending on the computer's settings.

NOTE

- It is not compatible with an MP3 player, digital camera, a USB device for a mobile phone, etc.
- The unit cannot charge a USB device.

Playback order of files

When there are multiple folders containing music files, the playback order of folders is automatically set when this unit reads the media. The files in each folder are played back in the order in which the files were recorded on the media, from the oldest date and time.

- For playback of files recorded on USB, files in the first folder on the first layer are played first, next folders on the second layer in the folder, then next on the third layer, and so on in this order. Then accordingly files on another first layer are played.



The playback order displayed on a PC may differ from the actual playback order.

NOTE

The playback order may differ from the order in which the folders or files were recorded if you delete or add a folder or file on USB. This occurs because of data recording specifications and is not a malfunction.



About folders and files

Music files recorded on a USB memory device are divided into large segments (folders) and small segments (files). Files are stored in folders, and folders can be placed for storage in a hierarchy. The unit can recognize up to 8 levels of folders.

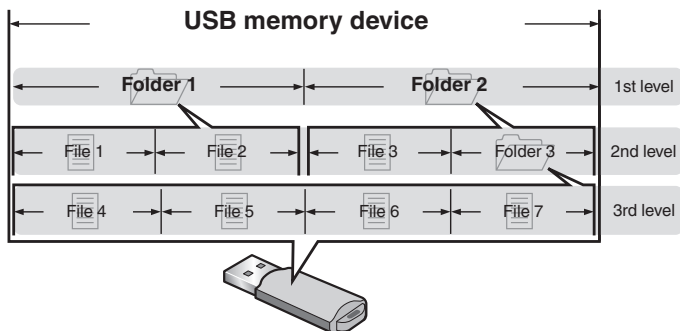

How to handle media

- Do not eject a USB memory device or turn off the unit while a USB memory device is being played. This may result in malfunction or loss of the USB memory device's data.
- Do not attempt to open or modify a USB memory device.
- USB memory device and files can be damaged by static electricity. Do not touch the metal contacts of a USB memory device with your fingers.
- Do not use warped USB memory device.
- After use, be sure to remove any disc or USB memory device, and store it in its proper case, to avoid dust, scratches and deformation.
- Do not store discs in the following places:
 1. Places exposed to direct sunlight for long periods of time
 2. Dusty or humid places
 3. Places exposed to heat from heaters, etc.



D/A converter

■ Specifications of supported files

□ USB-DAC

	Sampling frequency	Bit length
DSD (2-channel)	2.8/5.6 MHz	1 bit
Linear PCM (2-channel)	32/44.1/48/88.2/96/ 176.4/192 kHz	16/24 bits

□ Coaxial/Optical

	Sampling frequency	Bit length
Linear PCM (2-channel)	32/44.1/48/64/88.2/96/ 176.4/192 kHz	16/24 bits



Explanation of terms

DSD (Direct-Stream Digital)

One of the audio data recording methods, it is the signal aspect used to store audio signals on a super audio CD, and is Δ - Σ modulated digital audio. It is configured of an array of single bit values at a 2.8224MHz sampling rate.

MP3 (MPEG Audio Layer-3)

This is an internationally standardized audio data compression scheme, using the “MPEG-1” video compression standard. It compresses the data volume to about one eleventh its original size while maintaining sound quality equivalent to a music CD.

MPEG (Moving Picture Experts Group), MPEG-2, MPEG-4

These are the names for digital compression format standards used for the encoding of video and audio. Video standards include “MPEG-1 Video”, “MPEG-2 Video”, “MPEG-4 Visual”, “MPEG-4 AVC”. Audio standards include “MPEG-1 Audio”, “MPEG-2 Audio”, “MPEG-4 AAC”.

WMA (Windows Media Audio)

This is the audio compression technology developed by Microsoft Corporation.

WMA data can be encoded using Windows Media® Player.

To encode WMA files, only use applications authorized by Microsoft Corporation. If you use an unauthorized application, the file may not work properly.

Sampling frequency

Sampling involves taking a reading of a sound wave (analog signal) at regular intervals and expressing the height of the wave at each reading in digitized format (producing a digital signal).

The number of readings taken in one second is called the “sampling frequency”. The larger the value, the closer the reproduced sound is to the original.



Dynamic range

The difference between the maximum undistorted sound level and the minimum discernible level above the noise emitted by the device.

Bit rate

This expresses the read amount per 1 second of video/audio data recorded in a disc. A larger number means higher sound quality, but also means a larger file size.

Linear PCM

This is an uncompressed PCM (Pulse Code Modulation) signal. This is the same system used for CD audio but uses 192 kHz, 96 kHz, and 48 kHz sampling frequencies on Blu-ray Disc or DVD and provides higher resolution than CD.



Trademark information



“Made for iPod” and “Made for iPhone” mean that an electronic accessory has been designed to connect specifically to iPod, or iPhone, respectively, and has been certified by the developer to meet Apple performance standards.

Apple is not responsible for the operation of this device or its compliance with safety and regulatory standards. Please note that the use of this accessory with iPod, or iPhone, may affect wireless performance. iPad, iPhone, iPod, iPod classic, iPod nano, iPod shuffle and iPod touch are trademarks of Apple Inc., registered in the U.S. and other countries.

- Individual users are permitted to use iPhone, iPod, iPod classic, iPod nano, iPod shuffle, and iPod touch for private copy and playback of non-copyrighted contents and contents whose copy and playback is permitted by law. Copyright infringement is prohibited by law.



Adobe, the Adobe logo and Reader are either registered trademarks or trademarks of Adobe Systems Incorporated in the United States and/or other countries.



Specifications

■ Audio performance

- Analog output

Channels:	2-channels
Playable frequency range:	2 Hz – 96 kHz
Playable frequency response:	2 Hz – 50 kHz (–3 dB) (DSD mode, PCM sampling frequency: 192 kHz) 2 Hz – 20 kHz (PCM sampling frequency: 44.1 kHz)
S/N:	110 dB (Audible range)
Dynamic range:	106 dB (DSD/192 kHz) (Audible range) 101 dB (44.1 kHz)
Harmonic distortion:	0.0012 % (1 kHz, Audible range)
Unbalanced output	
• Fixed:	2.3 V RMS (PCM) 1.7 V RMS (DSD)
• Variable:	2.3 V RMS (PCM) (Volume max./Gain: Low) 1.7 V RMS (DSD) (Volume max./Gain: Low)
Headphone output:	800 mW/32 Ω/ohms (Volume max.)



- Analog input

Input sensitivity/impedance: 200 mVrms/22 k Ω /kohms

- Digital input

Coaxial: 0.5 Vp-p / 75 Ω /ohms

Optical : -27 dBm or lator

USB (Front): USB Type A (USB 2.0 Full speed)

USB (Rear): USB Type B (USB 2.0 High speed)

■ General

Power supply voltage/frequency: AC230 V, 50/60 Hz

Power consumption (EN60065) : 35 W

Power consumption in standby mode: 0.3 W

For the purpose of improvement, the specifications and design are subject to change without notice.



■ Dimensions

Unit : mm

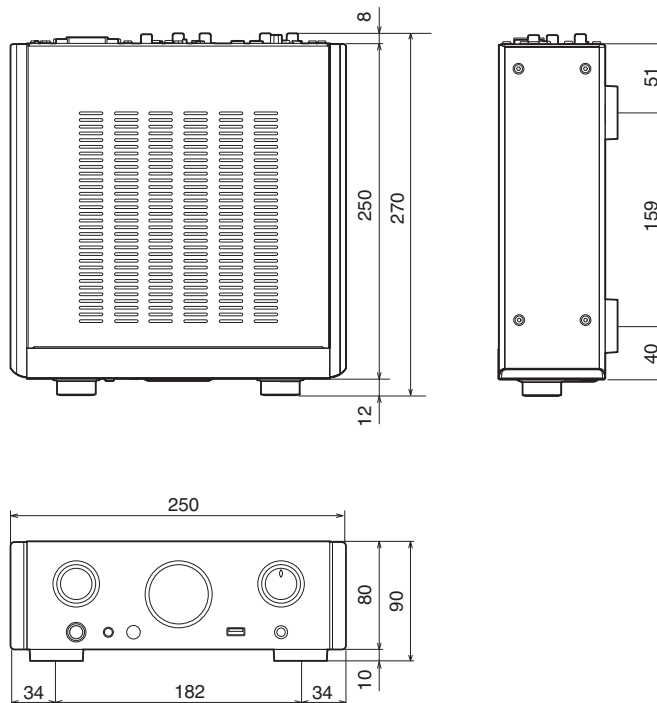

■ Weight : 5 kg



Index

A		D		P	
Accessories	4	D/A converter function	28, 62	Playing back an iPod	38
Audio cable	15, 16	Display's brightness	27	Playing a USB memory device	42
Audio Device Settings (Mac OS X only)	35	DSD	62, 63		
B		F		R	
Bit rate	59, 64	Front panel	8	Random playback	41, 45
C		I		Rear panel	11
Charging the iPod	41	Inserting the batteries	5	Remote connector cable	15, 22
Coaxial digital cable	15, 17	Installing the dedicated driver (Windows OS only)	29	Remote control connection	22
Connecting a computer	18	M		Remote control unit	12
Connecting an amplifier	16	Menu map	47	Repeat playback	41, 45
Connecting an iPod	20	MP3	42, 59, 63		
Connecting a USB memory device	20	O		S	
Connecting a power cord	23	Optical cable	15, 17	Sampling frequency	59, 62, 63
				Selecting the input source	26
				Stereo mini plug cable	19
				Supported iPod/iPhone models	21
				T	
				Turning the power on	25
				U	
				USB cable	15, 18, 20
				USB-DAC	18, 28, 62



**W**

WAV 42, 59

WMA 42, 59, 63



www.marantz.com

You can find your nearest authorized distributor or dealer on our website.

marantz[®] is a registered trademark.

D&M Holdings Inc.
3520 10359 00AM